



CATÁLOGO GENERAL  
2017 / 2018

# ÍNDICE

BAÑO  
03



COCINA  
13

MENAJE  
21

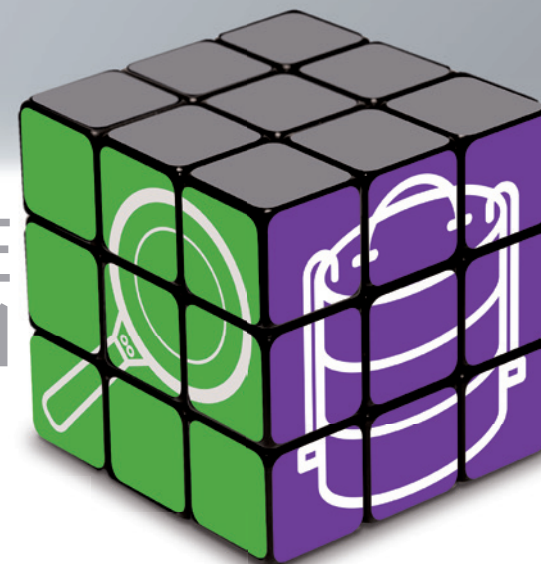

ALACENA  
37

PLANCHA  
47



FEATURES  
IN ENGLISH  
51



# BAÑO



ANALIZADORES CORPORALES ..... 04



BÁSCULAS ELECTRÓNICAS ..... 09



ANALIZADORES CORPORALES BLUETOOTH..... 05



BÁSCULAS MECÁNICAS ..... 12



BÁSCULAS ESPECIALES ..... 07



### ANALIZADOR CORPORAL 6 FUNCIONES BLANCO ALUMINIO

MOD. 533

- Analiza: Masa muscular. Agua corporal. Grasa corporal. Densidad ósea.
- Informa: Calorías diarias recomendadas. Peso.
- Base de cristal de seguridad "temperit" de 6 mm de espesor.
- Memoria para 10 personas.
- Visor "LCD" de gran tamaño. 4 dígitos.
- 4 sensores alta precisión.

U/C 6 EAN 8436017658217

180 kg CAPACIDAD 100 g MEMO 10

### ANALIZADOR CORPORAL 6 FUNCIONES NEGRO 180 KG

MOD. 531

- Analiza: Masa muscular. Agua corporal. Grasa corporal. Densidad ósea.
- Informa: Calorías diarias recomendadas. Peso.
- Memoria para 12 personas.
- Base de cristal de seguridad "temperit" de 5 mm de espesor.
- Visor "LCD" de gran tamaño. 4 dígitos.
- 4 sensores alta precisión.

U/C 6 EAN 8436017658088

180 kg CAPACIDAD 100 g MEMO 12



### ANALIZADOR CORPORAL 6 FUNCIONES VISOR XXL BLANCO

MOD. 565BL

- Visor "LCD" 4 dígitos XXL para una mejor visión.
- Analiza: Masa muscular. Agua corporal. Grasa corporal. Densidad ósea.
- Informa: Calorías. Peso.
- Memoria para 10 personas.
- Base de cristal de seguridad "temperit" de 6 mm de espesor.
- 4 sensores alta precisión.

U/C 6 EAN 8436017655612

150 kg CAPACIDAD 100 g MEMO 10



### ANALISADOR FITNESS MOD. 533

- Analisa: Masa muscular. Agua corporal. Gordura corporal. Densidade óssea.
- Informa: Calorias diárias recomendadas. Peso.
- Memória para 10 pessoas.
- Base em vidro de segurança "temperit" com 6 mm de espessura.
- Grande visor "LCD". 4 dígitos.
- 4 sensores. Elevada precisão.

### ANALISADOR FITNESS MOD. 531

- Analisa: Masa muscular. Agua corporal. Gordura corporal. Densidade óssea.
- Informa: Calorias diárias recomendadas. Peso.
- Memória para 12 pessoas.
- Base em vidro de segurança "temperit" com 5 mm de espessura.
- Grande visor "LCD". 4 dígitos
- 4 sensores. Elevada precisão.

### ANALISADOR FITNESS MOD. 565BL

- Extra grande display LCD 4 dígitos para facilitar a visualização.
- Analisa: Masa muscular. Agua corporal. Gordura corporal. Densidade óssea.
- Informa: Calorias diárias recomendadas. Peso.
- Memória para 10 pessoas.
- Base em vidro de segurança "temperit" com 6 mm de espessura.
- 4 sensores. Elevada precisão.

PESO  
 Agua corporal  
 Grasa corporal  
 AVISADOR BATERIA BAJA  
 Masa muscular  
 Densidad ósea  
 Kcal  
 3 años garantía



**ANALISADOR CORPORAL BLUETOOTH MOD. 595**

- Tecnología Bluetooth compatible com dispositivos iOS\* e Android.
- Aplicação "Smart Scale".
- Superfície de vidro Hi-Tech ITO glass com sensores integrados no vidro.
- Tecnología ITO: elétrodos invisíveis no vidro. Máxima eficiência.
- Analisa: Massa muscular. Agua corporal. Gordura corporal. Gordura visceral. Massa ósea. Índice de massa corporal.
- Informa: Calorías diárias. Peso.
- Memória para 8 pessoas.

**ANALISADOR CORPORAL BLUETOOTH ALTA TECNOLOGÍA MOD. 595**

- Tecnología Bluetooth compatible com dispositivos iOS\* y Android.
- Aplicación "Smart Scale".
- Superficie de cristal Hi-tech ITO glass con sensores integrados en el cristal.
- Tecnología ITO: electrodos invisibles en el cristal. Máxima eficiencia.
- Analiza: Masa muscular. Agua corporal. Grasa corporal. Grasa visceral. Masa ósea. Índice de masa corporal.
- Informa: Calorías diarias. Peso.
- Memoria para 8 personas.



U/C 4 EAN 8436017658545



**ANALISADOR CORPORAL BLUETOOTH MOD. 592**

- Tecnología Bluetooth compatible com dispositivos iOS\* e Android.
- Aplicação "FitBrick".
- Analisa: Massa muscular. Agua corporal. Gordura corporal. Massa ósea. Índice de massa corporal.
- Informa: Taxa metabólica basal. Peso.
- Sem limite de memórias.
- Opção programar meta de peso.
- Função para pesar bebés.



**ANALISADOR CORPORAL BLUETOOTH 7 FUNCIONES 180 KG MOD. 592**

- Tecnología Bluetooth compatible com dispositivos iOS\* y Android.
- Aplicación "FitBrick".
- Analiza: Masa muscular. Agua corporal. Grasa corporal. Masa Osea. Índice de masa corporal.
- Informa: Tasa metabólica basal. Peso.
- Sin límite de memorias.
- Opción programar peso objetivo.
- Función para pesar bebés.

U/C 6 EAN 8436017658859





## ANALIZADOR CORPORAL 7 FUNCIONES **Bamboo** 180KG

MOD. 577

- Analiza: Masa muscular. Agua corporal. Grasa corporal. Densidad ósea. Índice de masa corporal.
- Informa: Calorías diarias recomendadas. Peso.
- Memoria para 10 personas.
- Superficie de bambú de 12 mm.
- Mandos táctiles.



U/C 6 EAN 8436017658095



## ANALIZADOR CORPORAL AGUA GRASA EXCLUSIVE

MOD. 534

- Memoria para 10 personas.
- Establece de forma independiente los porcentajes de agua y grasa corporal.
- Base de cristal de seguridad "temperit" de 5 mm de espesor.
- Pulsadores táctiles. Visor "LCD" de gran tamaño.



U/C 6 EAN 8436017658118



## ANALIZADOR CORPORAL 7 FUNCIONES VÍDRIO PLATA

MOD. 564

- Visor "LCD" XXL para una mejor visión.
- Analiza: Masa muscular. Agua corporal. Grasa corporal. Densidad ósea. Índice de masa corporal.
- Informa: Calorías diarias recomendadas. Peso.
- Memoria para 10 personas.

U/C 4 EAN 8436017657869



## ANALISADOR FITNESS "BAMBOO" MOD. 577

- Analiza: Massa muscular. Agua corporal. Gordura corpora. Densidade óssea. Índice de massa corporal.
- Informa: Calorias diárias recomendadas. Peso.
- Memória para 10 pessoas.
- Superfície de bambu de 12 mm.
- Botão tácte.

## ANALISADOR DE GORDURA E ÁGUA MOD. 534

- Memória para 10 pessoas.
- Define, de forma independente, as percentagens de água e gordura corporal.
- Base em vidro de segurança "temperit" com 5 mm de espessura.
- Botão tácte. Visor "LCD" de grande visualização.

## ANALISADOR FITNESS MOD. 564

- Extra grande display LCD para facilitar a visualização.
- Analisa: Massa muscular. Agua corporal. Gordura corporal. Densidade óssea. Índice de massa corporal.
- Informa: Calorias diárias recomendadas. Peso.
- Memória para 10 pessoas.





**BALANÇA PESA MALAS "U-POWER"**  
**MOD. 55K**

- Ecológica. Tecnología sin baterías.
- U-Power: geração de energia automática.
- Visor "LCD".
- Função de tara.
- Indicador de peso excessivo.

**BÁSCULA PESA MALETAS ECOLÓGICA SIN PILAS "U-POWER"**

MOD. 55K

- Ecológica. Tecnología sin pilas.
- U-Power: generación de energía automática.
- Visor "LCD".
- Función de tara.
- Indicador de sobrepeso.

U/C 12 EAN 8436017659597



**NOVEDAD**  
**OTOÑO**



Expositor de 12 unidades  
30,6 x 15,4 x 18,8 cm



**BALANÇA ELETRÓNICA "U-POWER"**  
**MOD. 499**

- Ecológica. Tecnología sin baterías.
- U-Power: geração de energia automática.



**BÁSCULA ECOLÓGICA SIN PILAS "U-POWER" BLANCA**

MOD. 499

- Sin energía solar, generación de energía por impulso, con solo un impulso generamos la energía suficiente para pesarse.
- Tecnología sin pilas. U-Power: generación de energía automática.

U/C 4 EAN 8436017659047



**BALANÇA ELETRÓNICA PARA PESAR BEBÉS**  
**MOD. 590**

- Superfície tamanho grande.
- Resultado imediato do peso.
- Função fixar peso: regista o peso, mesmo com movimento.
- Grande visor "LCD". 5 dígitos.
- Função de tara.
- 4 sensores. Elevada precisão.

**BÁSCULA PESA BEBÉS 20 KG BLANCA**

MOD. 590

- Superficie de gran tamaño.
- Resultado del peso inmediato.
- Función fijar peso: registra el peso aún con movimiento.
- Visor "LCD" 5 dígitos de gran visión.
- Función de tara.
- 4 sensores, alta precisión.

U/C 4 EAN 8436017657661



## BÁSCULA ELECTRÓNICA CON ESTACIÓN METEREOLÓGICA



Módulo de exterior incluido

MOD. 530

- Informa: Previsión del tiempo. Temperatura interior. Temperatura exterior. Peso. Hora, alarma.
- Base de cristal de seguridad "Temperit" de 6 mm. de espesor.
- 4 sensores. Alta precisión. Visor "LCD" auto-luminiscente. 4 dígitos.
- Conexión / Desconexión automática.
- Indicador de sobrepeso.

U/C 4 EAN 8436017655162



## BÁSCULA SOLAR 180 KG. ECOLÓGICA

MOD. 580

- Ecológica. Sin pilas.
- Funciona con energía solar y luz artificial.
- Mínima iluminación necesaria, sólo 20 lux.
- 4 sensores. Alta precisión.

U/C 5 EAN 8436017655834



Ecológica. Sin pilas.



## BÁSCULA SOLAR ECOLÓGICA

MOD. 578

- Ecológica. Sin pilas.
- Funciona con energía solar y luz artificial.
- 4 sensores. Alta precisión.
- Mínima iluminación necesaria 40 lux.
- Visor "LCD" dígitos de gran visión. 4 dígitos.

U/C 6 EAN 8436017656831



Ecológica. Sin pilas.

## BALANÇA ELETRÓNICA DE CASA DE BANHO EM VIDRO "METEO"

MOD. 530

- Informa: Previsão do tempo. Temperatura interior. Temperatura exterior. Peso. Hora. Alarma.
- Base em vidro de segurança "temperit" com 6 mm de espessura.
- 4 sensores. Elevada precisão. Visor "LCD" auto luminiscente. 4 dígitos.
- Liga / Desliga-se automaticamente.
- Indicador de peso excessivo.

## BALANÇA DE CASA DE BANHO SOLAR ELETRÓNICA

MOD. 580

- Ecológica. Sem pilhas.
- Funciona com energia solar e luz artificial.
- Iluminação mínima necessária, apenas 20 lux.
- 4 sensores. Elevada precisão.

## BALANÇA DE CASA DE BANHO SOLAR ELETRÓNICA

MOD. 578

- Ecológica. Sem pilhas.
- Funciona com energia solar e luz artificial.
- 4 sensores. Elevada precisão.
- Iluminação mínima necessária 40 lux.
- Grande visor "LCD". 4 dígitos.





**BALANÇA ELECTRÓNICA DE CASA DE BANHO MOD. 496N**

- Base em aço inoxidável.
- Informa: peso e temperatura ambiente.
- Visor "LCD" auto-luminiscente.
- 4 sensores. Elevada precisão.
- Liga / Desliga-se automaticamente.
- Indicador de peso excessivo.

**BALANÇA ELECTRÓNICA DE CASA DE BANHO MOD. 498**

- Superfície "HPL":
  - Laminado de grande resistência.
  - Ideal para locais húmidos.
- Informa: peso e temperatura ambiente.
- Visor "LCD" auto-luminiscente.
- 4 sensores. Elevada precisão.
- Liga / Desliga-se automaticamente.
- Indicador de peso excessivo.

**BALANÇA ELECTRÓNICA DE CASA DE BANHO MOD. 430**

- Estrutura extra resistente até 180 kg de capacidade.
- Modelo extra-plano.
- Grande visor "LCD". 4 dígitos.
- 4 sensores. Elevada precisão.
- Liga automaticamente.
- Desliga-se automaticamente.
- Indicador de peso excessivo.





**BÁSCULA DE BAÑO ELECTRÓNICA**

MOD. 496N

- Superficie en acero inoxidable.
- Informa: peso y temperatura ambiente.
- Visor "LCD" autoluminiscente.
- 4 sensores. Alta precisión.
- Conexión / Desconexión automática.
- Indicador de sobrepeso.

U/C 6 EAN 8436017659610
 



**NOVE DAD**  
OTOÑO



**NOVE DAD**  
OTOÑO

**BÁSCULA DE BAÑO ELECTRÓNICA**

MOD. 498

- Superficie "HPL":
  - Laminado de alta resistencia.
  - Ideal para lugares húmedos.
- Informa: peso y temperatura ambiente.
- Visor "LCD" autoluminiscente.
- 4 sensores. Alta precisión.
- Conexión / Desconexión automática.
- Indicador de sobrepeso.

U/C 6 EAN 8436017659627
 



**BÁSCULA DE BAÑO ELECTRÓNICA**

MOD. 430

- Estructura extra resistente hasta 180 kg de capacidad.
- Diseño extraplano.
- Visor "LCD" de gran tamaño. 4 dígitos.
- 4 sensores, alta precisión.
- Conexión automática.
- Desconexión automática.
- Indicador de sobrepeso.

U/C 6 EAN 8436017659603
 

**NOVE DAD**  
OTOÑO





Expositor de 6 unidades  
36 x 25,5 x 38,9 cm

## BÁSCULA CRISTAL GRAN VISOR COLOR SURTIDO 180 KG

MOD. 493N

- Base de cristal de seguridad "temperit" de 6 mm de espesor.
- Visor "LED" de gran tamaño. 4 dígitos.
- 4 sensores. Alta precisión.

U/C 6 (1 exp. colores surtidos) EAN 8436017658842



Disponible en 3 colores



## BÁSCULA TRANSPARENTE Y NEGRO

MOD. 503

- Base de cristal de seguridad "temperit" de 6 mm de espesor.
- Visor "LCD" dígitos de gran visión. 4 dígitos.
- 4 sensores. Alta precisión.

U/C 4 EAN 8436017654547



## BÁSCULA CRISTAL BLANCA ALUMINIO 180 KG

MOD. 495

- Base de cristal de seguridad "temperit" de 6 mm de espesor.
- Visor "LCD" de gran tamaño. 4 dígitos.
- 4 sensores. Alta precisión.

U/C 6 EAN 8436017657265



## BALANÇA ELETRÓNICA DE CASA DE BANHO EM VIDRO MOD. 493N

- Base em vidro de segurança "temperit" com 6 mm de espessura.
- Grande visor "LED". 4 dígitos.
- 4 sensores. Elevada precisão.

## BALANÇA DE CASA DE BANHO ELETRÓNICA MOD. 503

- Base em vidro de segurança "temperit" com 6 mm de espessura.
- 4 sensores. Elevada precisão.
- Grande visor "LCD". 4 dígitos.

## BALANÇA DE CASA DE BANHO ELETRÓNICA MOD. 495

- Base em vidro de segurança "temperit" com 6 mm de espessura.
- Grande visor "LCD". 4 dígitos.
- 4 sensores. Elevada precisão.



**BALANÇA ELETRÔNICA DE CASA DE BANHO EM VIDRO MOD. 290**

- Base em vidro de segurança "temperit" com 6 mm de espessura.
- Grande visor "LCD". 4 dígitos.
- 4 sensores. Elevada precisão.

**BALANÇA ELETRÔNICA DE CASA DE BANHO MOD. 400**

- Superfície tamanho grande.
- Modelo extra-plano.
- Grande visor "LCD". 4 dígitos.
- 4 sensores. Elevada precisão.

**BALANÇA ELETRÔNICA DE CASA DE BANHO EM VIDRO MOD. 450**

- Base em vidro de segurança "temperit" com 6 mm de espessura.
- Grande visor "LCD". 4 dígitos.
- 4 sensores. Elevada precisão.

**BALANÇA ELETRÔNICA DE CASA DE BANHO EM BAMBÚ MOD. 494**

- Superfície de bambu prensado de produção sustentável de 16 mm.
- Grande visor "LCD". 4 dígitos.
- 4 sensores. Elevada precisão.



**BÁSCULA CRISTAL CON MARCO DE COLOR MOD. 290**

- Base de cristal de seguridad "temperit" de 6 mm de espesor.
- Visor "LCD" de gran tamaño. 4 dígitos.
- 4 sensores. Alta precisión.

Disponibile en 3 colores	U/C	EAN
Mod. 290V	6 (1 exp.)	8436017658125
Mod. 290R	6 (1 exp.)	8436017658132
Mod. 290P	6 (1 exp.)	8436017658149



**BÁSCULA PLÁSTICO COLOR SURTIDO MOD. 400**

- Superficie de gran tamaño.
- Diseño extraplano.
- Visor "LCD" 4 dígitos de gran visión.
- 4 sensores, alta precisión.

U/C	8 (1 exp. colores surtidos)	EAN	8436017657470
-----	-----------------------------	-----	---------------

Disponibile en 4 colores



Medidas  
31 x 29 cm



**BÁSCULA DISEÑO MARCO VERDE NEGRO 180 KG MOD. 450**

- Base de cristal de seguridad "temperit" de 6 mm de espesor.
- Visor "LCD" de gran tamaño. 4 dígitos.
- 4 sensores. Alta precisión.

U/C	6	EAN	8436017657654
-----	---	-----	---------------



**BÁSCULA Bamboo 180 KG MOD. 494**

- Superficie en bambú prensado de 16 mm.
- Visor "LCD" de gran tamaño. 4 dígitos.
- 4 sensores. Alta precisión.

U/C	6	EAN	8436017655773
-----	---	-----	---------------





### BÁSCULA MECÁNICA NEGRA

MOD. 67

- Superficie de gran tamaño.
- Base-mueble epoxi.
- Números extragrandes.
- Control manual de ajuste.

U/C 10 EAN 8436017657296



### BÁSCULA MECÁNICA BLANCA

MOD. 63

- Superficie de gran tamaño.
- Base-mueble epoxi.
- Números extragrandes.
- Control manual de ajuste.

U/C 10 EAN 8436017657234



### BALANÇA MECÂNICA DE CASA DE BANHO MOD. 67

- Superfície tamanho grande.
- Estrutura "epoxi".
- Números extra-grandes.
- Controle manual da regulação.

### BALANÇA MECÂNICA DE CASA DE BANHO MOD. 63

- Superfície tamanho grande.
- Estrutura "epoxi".
- Números extra-grandes.
- Controle manual da regulação.







# COCINA



**BALANZAS ELECTRÓNICAS GRAN PESADA ..... 14**



**BALANZAS ELECTRÓNICAS ..... 16**



**BALANZAS MECÁNICAS ..... 20**



Opción colocación mural

Medidas:  
30 x 22,5  
cm

## BALANZA 10 KG INOX

MOD. 699

- Superficie en acero inoxidable.
- Alta precisión electrónica.
- Opción colocación mural.

U/C 8 EAN 8436017659054



## BALANZA 15 KG GRAN SUPERFICIE VERDE

MOD. 715

- Gran superficie de cristal "temperit": 30 x 22,5 cm.
- Alta precisión electrónica.
- Función bloqueo de la pesada para grandes volúmenes.
- Opción colocación mural.

U/C 8 EAN 8436017657944



Función BLOQUEO DE LA PESADA para grandes volúmenes

## BALANÇA ELETRÓNICA DE COZINHA MOD. 699

- Base em aço inoxidável.
- Elevada precisão electrónica.
- Opção colocação na parede.

## BALANÇA ELETRÓNICA DE COZINHA MOD. 715

- Superfície em vidro "temperit", tamanho grande: 30 x 22,5 cm.
- Elevada precisão electrónica.
- Função de bloqueio da pesagem para grandes volumes.
- Opção colocação na parede

## BALANÇA ELETRÓNICA DE COZINHA MOD. 719

- Base em aço inoxidável.
- Elevada precisão electrónica.
- Visor "LCD" auto-luminiscente.
- Relógio integrado.

## BALANZA INOX 15 KG RELOJ Y TEMPORIZADOR

MOD. 719

- Superficie en acero inoxidable.
- Alta precisión electrónica.
- Visor "LCD" autoluminiscente.
- Reloj integrado.

U/C 6 (1 exp.) EAN 8436017659351



Expositor de 6 unidades 23,8 x 20 x 20 cm





### BALANÇA ELETRÓNICA DE COZINHA MOD. 780

- Superfície mista: vidro "temperit" e aço inoxidável.
- Função de bloqueio da pesagem para grandes volumes.
- Elevada precisão electrónica.
- Grande visor "LCD".
- Botões táctes.
- Função de tara.
- Indicador de sobrecarga.
- Opção colocação na parede.

### BALANZA ELECTRÓNICA

MOD. 780

- Superfície mixta: cristal "temperit" y acero inoxidable.
- Función bloqueo de la pesada para grandes volúmenes.
- Alta precisión electrónica.
- Visor "LCD" de gran tamaño.
- Pulsadores táctiles.
- Función de tara.
- Indicador de sobrepeso.
- Opción colocación mural.

**NOVEDAD**  
OTOÑO



U/C 6 (1 exp.) EAN 8436017659658



Medidas:  
30 x 21 cm



Función BLOQUEO DE LA PESADA para grandes volúmenes



Expositor de 6 unidades 24 x 23,2 x 32,4 cm

### BALANÇA ELETRÓNICA DE COZINHA "BAMBOO" MOD. 720

- Superfície de bambu prensado de produção sustentável de 5 mm.
- Elevada precisão electrónica.
- Visor "LCD" auto-luminiscente.
- Relógio integrado.
- Função de temporizador.
- Indicador de sobrecarga.

**NOVEDAD**  
OTOÑO

### BALANZA ELECTRÓNICA **Bamboo**

MOD. 720

- Superfície en bambú prensado de producción sostenible de 5 mm.
- Alta precisión electrónica.
- Visor "LCD" autoluminiscente.
- Reloj integrado.
- Función temporizador.
- Indicador de sobrepeso.



U/C 6 (1 exp.) EAN 8436017659580



Expositor de 6 unidades 20 x 20 x 23,8 cm





Medidas:  
13 x 10 cm



2 tapas protectoras  
con función bandeja

### BALANZA ALTA PRECISIÓN, DECIGRAMOS 0,1 GR - 3 KG

MOD. 773

- Superficie de acero inoxidable.
- Gran precisión de pesada.
- Visor LCD auto-luminiscente.
- Pulsador de encendido.
- Función de calibración.
- Función bloqueo de la pesada.

U/C 8 EAN 8436017659061



### BALANZA 2 PLATAFORMAS PRECISIÓN Y DOMÉSTICA

MOD. 770

- Plataformas independientes.
- Capacidad 5 kg. Graduación 1 g.
- Medidas 23 x 16 cm.
- Alta precisión electrónica con 5 sensores.
- Base de acero inoxidable extraíble, especial para pesadas pequeñas:
  - Capacidad 350 g. Graduación 0,1 g.
  - Medidas 7 x 6 cm.

U/C 8 EAN 8436017657555

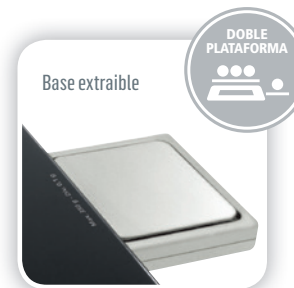

### BALANZA, RELOJ, TEMPORIZADOR, ESTACIÓN METEO 3 KG

MOD. 756

- Alta precisión electrónica.
- Visor "LCD" central: día, hora, alarma, temperatura, humedad.
- Visor "LCD" auto-luminiscente: peso.
- Opción colocación mural.

U/C 8 EAN 8436017654622



Diámetro:  
20 cm

### BALANZA EXTRA PLANA REDONDA Ø22 CM INOX

MOD. 764

- Superficie de acero inoxidable.
- Diseño extraplano
- Visor "LCD". 4 dígitos.
- Alta precisión electrónica.

U/C 6 EAN 8436017658200



Diámetro:  
22 cm



### BALANZA DE PRECISÃO MOD. 773

- Base em aço inoxidável.
- Grande precisão de pesagem.
- Visor LCD auto-luminiscente
- Botão para ligar.
- Função de calibração
- Função de bloqueio da pesagem

### BALANZA ELETRÓNICA DE COZINHA PLATAFORMA DUPLA MOD. 770

- Plataformas independentes.
- Capacidade 5 kg / Graduação 1 g.
- Medidas 23 x 16 cm.
- Base extraível de aço inoxidável, especial para pequenas pesagens:
  - Capacidade 350 g / Graduação 0,1 g.
  - Medidas 7 x 6 cm.
- Elevada precisão eletrónica com 5 sensores.

### BALANZA ELETRÓNICA MULTIFUNÇÃO DE COZINHA MOD. 756

- Elevada precisão eletrónica.
- Visor "LCD" central: data hora, alarme, temperatura, humidade.
- Visor "LCD" auto-luminiscente: peso.
- Opção colocação na parede.

### BALANZA ELETRÓNICA DE COZINHA MOD. 764

- Base em aço inoxidável.
- Elevada precisão eletrónica.
- Visor "LCD" de 4 dígitos.
- Modelo extraplano.





### BALANÇA ELETRÓNICA DE COZINHA MOD. 762

- Base em vidro de segurança "temperit".
- Elevada precisión electrónica.
- Botões táctes.
- Grande visor "LCD" autoluminiscente.
- Analisa calorías e hidratos de carbono de 14 alimentos.

### BALANZA DIETÉTICA DE 14 ALIMENTOS 5 KG

MOD. 762

- Base de cristal de seguridad "temperit".
- Visor "LCD" autoluminiscente de gran tamaño.
- Alta precisión electrónica. Pulsadores táctiles.
- Analiza las calorías y carbohidratos de 14 alimentos.

U/C 8 EAN 8436017659078



*Dietética*



Analiza calorías y carbohidratos de 14 alimentos.



### BALANÇA ELECTRÓNICA DIETÉTICA NUTRICIONAL MOD. 790

- Pesa e analisa 7 valores nutricionais dos alimentos: calorías, proteínas, hidratos de carbono, sal, gordura, colesterol e fibra.
- Informação nutricional sobre 999 alimentos e ingredientes.
- Memória para 99 registros.

### BALANZA DIETÉTICA 7 VALORES DE 999 ALIMENTOS BLANCA MOD. 790

MOD. 790

- Pesa y analiza 7 valores nutricionales de los alimentos: calorías, proteínas, hidratos de carbono, sal, grasa, colesterol y fibra.
- Información nutricional sobre 999 alimentos e ingredientes.
- Memoria para 99 registros. Visión en pantalla del conjunto del resultado.



**NOVEDAD**  
PRIMAVERA



Visor LCD de gran tamaño

*Dietética Nutricional*

U/C 8 EAN 8436017659429



### BALANÇA ELETRÓNICA COM JARRO MOD. 766

- Informa: Peso. Volumen agua. Volumen leche.
- Jarro removível isento de BPA.
- Capacidade 1.200 ml.
- Botão para remover o jarro.

### BALANZA CON JARRA 2 KG - 1,2 LITROS VERDE

MOD. 766

- Informa: Peso. Volumen agua. Volumen leche.
- Capacidad 1.200 ml.
- Jarra extraíble libre de BPA.
- Pulsador para extraer la jarra.

U/C 6 EAN 8436017659115



1.200 ml





Recipiente de acero inoxidable extraíble



**BALANZA ROJA CON BOL ACERO INOX**

MOD. 765

- Informa: Peso. Volumen agua. Volumen leche.
- Alta precisión electrónica.
- Recipiente de acero inoxidable extraíble. Capacidad 1,8 L.

U/C 6 EAN 8436017657319

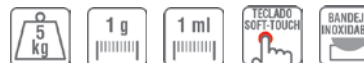

**BALANZA VERDE CON BOL ACRÍLICO**

MOD. 709N

- Alta precisión electrónica.
- Bol transparente de gran capacidad 2 L.
- Mandos táctiles.
- Visor "LCD" autoluminiscente.

U/C 6 EAN 8436017653014



**BALANÇA ELETRÓNICA DE COZINHA MOD. 709N**

- Elevada precisión electrónica.
- Recipiente transparente de grande capacidade 2 L.
- Botões tácteis.
- Visor "LCD" autoluminiscente.

**BALANÇA ELETRÓNICA DE COZINHA MOD. 717**

- Recipiente con pega preparado para sólidos e líquidos. Capacidad 300 ml.
- Elevada precisión electrónica.



Expositor de 6 unidades  
27,2 x 26,4 x 13 cm

**BALANZA BLANCA MINI 1 KG CON BOL 300 ML**

MOD. 717

- Bol con asa apto para sólidos y líquidos. Capacidad 300 ml.
- Alta precisión electrónica.

U/C 12 (2 exp. 6 u/c) EAN 8436017658194



*La mini*





### BALANZA ELETRÓNICA DE COZINHA MOD. 727N

- Elevada precisión electrónica.
- Botão táctil / Função de tara.

### BALANZA RECTANGULAR 20 X 14 SILUETAS KITCHEN

MOD. 727N

- Alta precisión electrónica.
- Pulsador táctil. Función de tara.

U/C	8 (1 exp. colores surtidos)	EAN	8436017656985
-----	-----------------------------	-----	---------------



Disponible en 4 colores



Disponible en 4 colores  
Expositor de 8 unidades 35,5 x 19 x 38 cm

### BALANZA ELETRÓNICA DE COZINHA MOD. 723

- Elevada precisión electrónica.
- Botão táctil / Função de tara.

Medidas:  
20 x 18 cm



Disponible en 4 colores  
Expositor de 8 unidades 19 x 38 x 25 cm

### BALANZA RECTANGULAR MARCO SURTIDO

MOD. 723

- Alta precisión electrónica.
- Mandos táctiles. Función de tara.

U/C	8 (1 exp. colores surtidos)	EAN	8436017657272
-----	-----------------------------	-----	---------------



Disponible en 4 colores



### BALANZA ELETRÓNICA DE COZINHA MOD. 722 / 722P

- Elevada precisión electrónica.
- Botão táctil / Função de tara.



Mod. 722 P  
En caja de PVC (3 por color)  
12 unidades por embalaje

### BALANZA CORONA COLORES SURTIDOS Ø 20 CM

MOD. 722P / 722

- Alta precisión electrónica.
- Pulsador táctil. Función de tara.

Mod. 722	U/C	8 (1 exp. colores surtidos)	EAN	8436017655865
Mod. 722P	U/C	12 (3 por color)	EAN	8436017656619



Disponible en 4 colores



Disponible en 4 colores  
Expositor de 8 unidades 47,6 x 22,1 x 19 cm

### BALANZA ELETRÓNICA DE COZINHA MOD. 729

- Informa: Peso. Volumen agua. Volumen leche.
- Elevada precisión electrónica.
- Visor "LCD" auto-luminiscente.

### BALANZA RECTANGULAR ROJA O VERDE

MOD. 729

- Informa: Peso. Volumen agua. Volumen leche.
- Visor "LCD" autoluminiscente.
- Alta precisión electrónica.

Disponibile en 2 colores	U/C	EAN
Mod. 729V	6 (1 exp.)	8436017659108
Mod. 729R	6 (1 exp.)	8436017659092



Expositor de 6 unidades  
21 x 19,5 x 20 cm





**BALANZA RETRO NARANJA O VERDE CON BOL inox**

MOD. 612

- Bol de acero inoxidable. Gran capacidad.
- Dial de fácil lectura.
- Cuerpo metálico.

Disponible en 2 colores	U/C	EAN
Mod. 612VE	6	8436017657784
Mod. 612NA	6	8436017657777



**BALANZA MECÁNICA 3 KG CON BOL, BOLA**

MOD. 603

- Recipiente graduado transparente apto para sólidos y líquidos. Capacidad 1 L.
- Innovador diseño.

U/C	8	EAN	8436017654561
-----	---	-----	---------------



**BALANZA MECÁNICA CON BOL BLANCA 3 KG**

MOD. 610N

- Diseño extraplano y visor horizontal.
- Bol con asa apto para sólidos y líquidos. Capacidad 1 L.
- Dial de fácil lectura.

U/C	6	EAN	8436017651928
-----	---	-----	---------------



**BALANÇA MECÂNICA DE COZINHA MOD. 612**

- Recipiente em aço inoxidável. Grande capacidade.
- Estrutura metálica.
- Visor de fácil leitura.

**BALANÇA MECÂNICA DE COZINHA MOD. 603**

- Recipiente transparente graduado preparado para sólidos e líquidos. Capacidade 1 L.
- Modelo inovador.

**BALANÇA MECÂNICA DE COZINHA MOD. 610N**

- Modelo extra-plano e visor horizontal.
- Visor de fácil leitura.
- Recipiente com pega preparado para sólidos e líquidos. Capacidade 1 L.







# MENAJE



SARTENES ..... 22



CAZO ..... 24



GRILL..... 28



BATERÍAS DE COCINA ..... 30



OLLAS RÁPIDAS A PRESIÓN ..... 32



CAFETERAS ..... 34



JARRAS PURIFICADORAS DE AGUA ..... 36



## SARTÉN ACERO ALIGERADO *Timanfaya*

MOD. SAC1

- Cuerpo de acero carbono ligero 2 mm.
- Recubrimiento antiadherente ILAG libre de PFOA.
- Mango acero inox con silicona.
- Exterior recubierto de silicona:
  - Especial anti-óxido.
  - Perfecta distribución del calor.



Exterior recubierto de silicona



Diámetro sartén	Modelo	U/C	EAN
20 cm	SAC120	6	8436017658224
24 cm	SAC124	6	8436017658231
26 cm	SAC126	6	8436017658699
28 cm	SAC128	6	8436017658248



## SARTÉN ACERO ESMALTADO *Tambora*

MOD. SEA

- Sartén de acero de esmalte vitrificado 1,5 mm.
- Recubrimiento "Stonite" Xylan® Plus de Whitford libre de PFOA.
- Perfecta distribución del calor.
- Mango ignífugo.



Diámetro sartén	Modelo	U/C	EAN
18 cm	SEA18	6	8436017658293
20 cm	SEA20	6	8436017658309
22 cm	SEA22	6	8436017658316
24 cm	SEA24	6	8436017658323
26 cm	SEA26	6	8436017658330
28 cm	SEA28	6	8436017658347
30 cm	SEA30	6	8436017658354



Perfecta distribución del calor



## FRIGIDEIRA EM AÇO CARBONO "TIMANFAYA"

MOD. SAC1

- Corpo em aço carbono leve 2 mm.
- Revestimento antiaderente ILAG isento de PFOA.
- Pega em aço inox com silicone.
- Exterior revestido de silicona:
  - Especial anti-ferrugem.
  - Distribuição perfeita do calor.

## FRIGIDEIRA ESMALTADA "TAMBORA"

MOD. SEA

- Frigideira de aço de esmalte vitrificado 1,5 mm.
- Revestimento antiaderente "Stonite" Xylan® Plus de Whitford isento de PFOA.
- Distribuição perfeita do calor.
- Pega à prova de fogo.



## SARTÉN ALUMINIO PENSADO *Mauna*

### MOD. S1 - SET S1

- Cuerpo de aluminio prensado 2,5 mm.
- Recubrimiento antiadherente Xylan® Plus de Whitford libre de PFOA.
- Perfecta distribución del calor.
- Fondo difusor "Full Induction".
- Mango ignífugo.

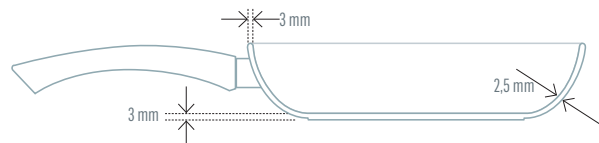

Diámetro sartén	Modelo	Diámetro base inducción	U/C	EAN
18 cm	S118	10,5 cm	6	8436017658361
20 cm	S120	12 cm	6	8436017658378
22 cm	S122	13,3 cm	6	8436017658385
24 cm	S124	15 cm	6	8436017658392
26 cm	S126	16,1 cm	6	8436017658408
28 cm	S128	17,4 cm	6	8436017658415
30 cm	S130	18,8 cm	6	8436017658422



### MOD. SET S1

Set de 3 sartenes:  
Diámetros 18, 22 y 26 cm



U/C 4 SETS EAN 8436017658729

## FRIGIDEIRA DE INDUÇÃO FULL "MAUNA"

### MOD. S1 - SET S1

- Em alumínio prensado de 2,5 mm.
- Revestimento antiaderente Xylan® Plus de Whitford isento de PFOA.
- Fundo difusor "Full Induction".
- Pega à prova de fogo.

## FRIGIDEIRA DE INDUÇÃO FULL "TEIDE"

### MOD. S

- Em alumínio prensado de 3 mm.
- Revestimento antiaderente Pfluo "Stonite" isento de PFOA.
- Fundo difusor indução total.
- Pega à prova de fogo.



## SARTÉN ALUMINIO PENSADO *Teide*

### MOD. S

- Cuerpo de aluminio prensado 3 mm.
- Recubrimiento antiadherente Pfluo "Stonite" libre de PFOA.
- Fondo difusor inducción total.
- Mango ignífugo.

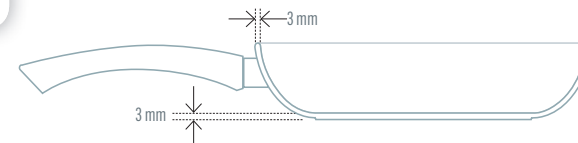

Diámetro sartén	Modelo	Diámetro base inducción	U/C	EAN
18 cm	S18	12,4 cm	6	8436017655926
20 cm	S20	12,8 cm	6	8436017655940
22 cm	S22	12,8 cm	6	8436017655964
24 cm	S24	16 cm	6	8436017655988
26 cm	S26	16 cm	6	8436017656107
28 cm	S28	18 cm	6	8436017656121
30 cm	S30	18,4 cm	6	8436017656145





**NOVEDAD**  
OTOÑO

## PAELLERA FULL INDUCTION *Jordan*

MOD. P34 - P38

- Fondo difusor "Full Induction".
- Recubrimiento antiadherente Pflun libre de PFOA.
- Perfecta distribución del calor.
- Cuerpo de aluminio prensado de 3 mm.

Diámetro paellera	Modelo	Raciones	U/C	EAN
34 cm	P34	6	4	8436017659801
38 cm	P38	8	4	8436017659818



## SARTÉN ALUMINIO CON ESPÁTULA 14 CM *Huevo Frito*

SM14N

- Recubrimiento antiadherente Pflun libre de PFOA. Ø 14 cm.
- Cuerpo de aluminio. Mango de silicona.
- Apta para cocinas de gas, eléctricas, vitrocerámica, halógenas.
- Espátula de silicona incluida.

U/C 12 (1 exp. colores surtidos) EAN 8436017658880



## CAZO ALUMINIO ECOLÓGICO MINI 12 CM

MOD. CME

- Antiadherente ecológico cerámico libre de PFOA y PTFE. Ø 12 cm.
- Capacidad 500 ml.
- Cuerpo de aluminio. Mango de silicona.
- Apta para cocinas de gas, eléctricas, vitrocerámica, halógenas.

U/C 12 (1 exp. colores surtidos) EAN 8436017655896

## PAELHEIRA FULL INDUCTION "JORDAN" MOD. P34 - P38

- Fondo difusor "Full Induction".
- Revestimiento antiadherente Pflun isento de PFOA.
- Distribuição perfeita do calor.
- Em alumínio prensado de 3 mm.

## FRIGIDEIRA ECOLÓGICA "OVO FRITO" MOD. SM14N

- Revestimiento antiadherente Pflun isento de PFOA. Diámetro 14 cm.
- Estrutura em alumínio. Pega em silicone.
- Preparada para fogões a gás, electricidade, vitrocerámica, halogéneas.
- Espátula de silicone incluída.

## FRIGIDEIRA MINI ECOLÓGICA MOD. CME

- Revestimiento antiadherente ecológico cerámico libre de PFOA e de PTFE. Diámetro 12 cm.
- Capacidade 500 ml.
- Estrutura em alumínio. Pega em silicone.
- Preparada para fogões a gás, electricidade, vitrocerámica, halogéneas.







## SARTÉN HONDA ALUMINIO FORJADO *Marsili*

MOD. SEW

### FRIGIDEIRA WOK DE INDUÇÃO FULL "MARSILI"

MOD. SEW

- Fundo difusor indução total.
- Revestimento antiaderente Pflun "Stonite" isento de PFOA.
- Estrutura de alumínio forjado.
- Exterior com silicone:
  - Especial anti-ferrugem.
  - Distribuição perfeita do calor.
- Pega à prova de fogo.

- Fondo difusor inducción total.
- Recubrimiento antiaderente Pflun Granite libre de PFOA.
- Cuerpo de aluminio forjado.
- Exterior con silicona:
  - Resistente a altas temperaturas.
  - Perfecta distribución del calor.
- Mango ignífugo.

Diámetro sartén	Modelo	Profundidad	Diámetro base inducción	U/C	EAN
20 cm	SEW20	6,2 cm	12,2 cm	6	8436017656633
24 cm	SEW24	7,2 cm	13 cm	6	8436017656657
28 cm	SEW28	7,5 cm	15,8 cm	6	8436017656671

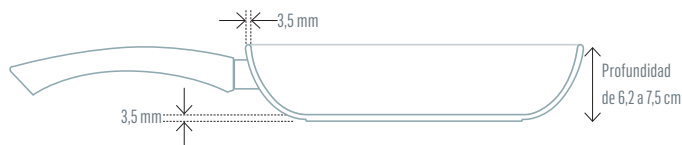

### FRIGIDEIRA FULL INDUCTION "FUJI"

MOD. SF1 - SET SF1

- Estrutura de alumínio forjado 3 mm.
- Revestimento antiaderente "Stonite" Xylan® Plus de Whitford isento de PFOA.
- Distribuição perfeita do calor.
- Pega à prova de fogo.
- Fundo difusor "Full Induction".

Diámetro sartén	Modelo	Diámetro base inducción	U/C	EAN
18 cm	SF118	12,1 cm	6	8436017658439
20 cm	SF120	13,3 cm	6	8436017658446
22 cm	SF122	14,8 cm	6	8436017658453
24 cm	SF124	16,1 cm	6	8436017658460
26 cm	SF126	17,4 cm	6	8436017658477
28 cm	SF128	18,8 cm	6	8436017658484
30 cm	SF130	19,2 cm	6	8436017658491

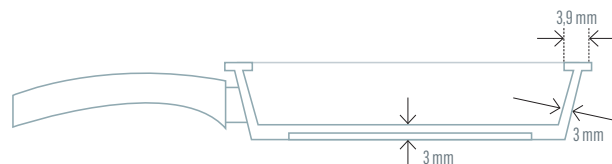

Fondo difusor "Full Induction"



## SARTÉN ALUMINIO FORJADO *Fuji*

MOD. SF1 - SET SF1

- Cuerpo de aluminio forjado 3 mm.
- Recubrimiento antiaderente "Stonite" Xylan® Plus de Whitford libre de PFOA.
- Fondo difusor "Full Induction".
- Perfecta distribución del calor.
- Mango ignífugo.



MOD. SET SF1  
Set de 2 sartenes:  
Diámetros 20 y 24 cm

U/C 4 SETS EAN 8436017658712





## SARTÉN ALUMINIO FORJADO GRANITE *Tacaná*

MOD. SF3

- Fondo difusor inducción total.
- Recubrimiento antiadherente Pfluo Granite libre de PFOA.
- Cuerpo de aluminio forjado
- Exterior con silicona:
  - Resistente a altas temperaturas.
  - Perfecta distribución del calor.
- Mango ignífugo.

Diámetro sartén	Modelo	Diámetro base inducción	U/C	EAN
18 cm	SF318	13,9 cm	6	8436017658620
20 cm	SF320	15,7 cm	6	8436017658637
22 cm	SF322	17,4 cm	6	8436017658644
24 cm	SF324	18,9 cm	6	8436017658651
26 cm	SF326	20,8 cm	6	8436017658668
28 cm	SF328	21,7 cm	6	8436017658675
30 cm	SF330	23,6 cm	6	8436017658682

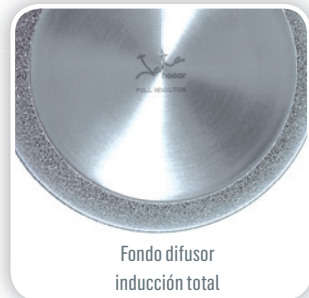
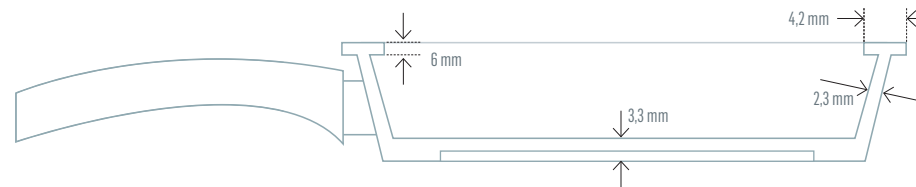

**GRANITE**



## FRIGIDEIRA FULL INDUCTION "TACANÁ" MOD. SF3

- Fondo difusor inducción total.
- Revestimiento antiadherente Pfluo Granite isento de PFOA.
- Estructura de aluminio forjado.
- Exterior com silicone:
  - Resistente a altas temperaturas.
  - Distribuição perfeita do calor.
- Pega à prova de fogo.





## SARTÉN ALUMINIO FORJADO *Golan*

MOD. SF4

NOVEDAD  
OTOÑO

- Fondo difusor inducción total.
- Recubrimiento antiadherente Dyflon libre de PFOA.
- Cuerpo de aluminio forjado 3 mm.
- Perfecta distribución del calor.
- Mango de acero inoxidable hueco remachado.
- Protector de sartén incluido.

Diámetro sartén	Modelo	U/C	EAN
18 cm	SF418	6	8436017659719
20 cm	SF420	6	8436017659726
22 cm	SF422	6	8436017659733
24 cm	SF424	6	8436017659740
26 cm	SF426	6	8436017659757
28 cm	SF428	6	8436017659764
30 cm	SF430	6	8436017659771



## FRIGIDEIRA ALUMÍNIO FORJADO DYFLON "GOLAN" MOD. SF4

- Fundo difusor indução total.
- Revestimento antiaderente Dyflon isento de PFOA.
- Estrutura de alumínio forjado 3 mm.
- Perfeita distribuição do calor.
- Pega de aço inoxidável oco rebitado.
- Protetor de frigideira incluído.



Fundo difusor inducción total



**GRATIS**  
Protector de sartén



MOD.  
SET SF4 2024  
Set de 2 sartenes:  
Diámetros 20 y 24 cm

U/C 4 SETS EAN 8436017659795



MOD.  
SET SF4 182226  
Set de 3 sartenes:  
Diámetros 18, 22 y 26 cm

U/C 4 SETS EAN 8436017659788







## GRILL ALUMINIO FUNDIDO M/PLEGABLE *Kilimanjaro*

MOD. GMA - GP35



- Mango abatible de madera.
- Fondo difusor inducción total.
- Recubrimiento antiadherente Pfluoon "Stonite" libre de PFOA.
- Aluminio fundido.

Medidas Grill	Modelo	Diámetro base inducción	U/C	EAN
24 x 24 cm	GMA24	17,1 cm	6	8436017658903
28 x 28 cm	GMA28	20,2 cm	6	8436017658910
25 x 35 cm	GP35	17,6 cm	6	8436017658927

## GRILL ACERO ESMALTADO 28X28 *Tambora*

MOD. GEA28

- Recubrimiento antiadherente "Stonite" Xylan® Plus de Whitford libre de PFOA.
- Perfecta distribución del calor.
- Mango ignífugo.

U/C	6	EAN	8436017658736
-----	---	-----	---------------



**NOVEDAD**  
**OTOÑO**

## PARRILLA GRILL REDONDA O RECTANGULAR *Fogo*

MOD. GR25 - GR33

- Hierro fundido esmaltado:
  - Perfecta distribución del calor.
  - Transmisión rápida de temperatura.
  - Mantenimiento del calor máximo.
  - Resistente y duradero.
  - Esmaltado exterior.
- Apta para: horno, barbacoa y todo tipo de cocinas.
- Fácil de limpiar.

Medidas Grill	Modelo	U/C	EAN
Ø 25 cm	GR25	4	8436017659672
33 x 21,5 cm	GR33	4	8436017659689



## GRILL FULL INDUCTION "KILIMANJARO" MOD. GMA - GP35

- Pega dobrável de madeira.
- Fondo difusor indução total.
- Revestimento antiaderente Pfluoon "Stonite" isento de PFOA.
- Alumínio fundido.

## GRELHADOR ESMALTADO "TAMBORA" MOD. GEA28

- Revestimento antiaderente "Stonite" Xylan® Plus de Whitford isento de PFOA.
- Distribuição perfeita do calor.
- Pega à prova de fogo.

## GRELHADOR GRILL "FOGO" MOD. GR25 - GR33

- Especial carnes e vegetais.
- Ferro fundido esmaltado:
  - Distribuição perfeita do calor. Transmissão rápida da temperatura.
  - Manutenção do calor máximo. Resistente e duradouro. Esmaltado interior e exterior.
- Adequado para: forno, churrasqueira e odas as fontes de calor.
- Fácil de limpar.







## BANDEJA GRILL ALUMINIO FORJADO INDUCCIÓN TOTAL *Bely*

MOD. GB36 - GB37

- Cuerpo de aluminio forjado 3 mm.
- Fondo difusor inducción total.
- Perfecta distribución del calor.
- Recubrimiento antiadherente Whitford Xylan® Plus libre de PFOA.
- Asas de silicona extraíbles.

Medidas	Modelo	Superficie de cocinado	U/C	EAN
36 x 23 x 5 cm	GB36	28 x 22 cm	6	8436017659481
38 x 27 x 5 cm	GB37	28 x 24 cm	6	8436017659498



NOVEDAD  
OTOÑO



Mod. GB36



Mod. GB37

## BANDEJA GRILL ASSADOR "BELY"

MOD. GB36 - GB37

- Estrutura de alumínio forjado 3 mm.
- Fundo difusor indução total.
- Distribuição perfeita do calor.
- Revestimento antiaderente Xylan® Plus de Whitford isento de PFOA.
- Pegas de silicone removíveis.

## GRILL FULL INDUCTION "BELY"

MOD. G24 - G28

- Estrutura de alumínio forjado 4 mm.
- Fundo difusor indução total.
- Distribuição perfeita do calor.
- Revestimento antiaderente Xylan® Plus de Whitford isento de PFOA.



NOVEDAD  
OTOÑO

## GRILL ALUMINIO FORJADO INDUCCIÓN TOTAL *Bely*

MOD. G24 - G28

- Cuerpo de aluminio forjado 4 mm.
- Fondo difusor inducción total.
- Perfecta distribución del calor.
- Recubrimiento antiadherente Xylan® Plus de Whitford libre de PFOA.

Medidas	Modelo	U/C	EAN
24 x 24 cm	G24	6	8436017659467
28 x 28 cm	G28	6	8436017659474





**NOVEDAD**  
OTOÑO

## BATERÍA ALUMINIO 3 PIEZAS FULL INDUCTION *Fuji*

MOD. BC3

- 3 piezas:
  - Cazuela de 24 cm con tapa.
  - Cazuela de 20 cm con tapa.
  - Cazo de 16 cm con tapa.
- Fondo difusor inducción total.
- Recubrimiento antiadherente "Stonite" Xylan® Plus the Whitford libre de PFOA.
- Cuerpo de aluminio forjado.
- Base sandwich de 3 mm para mantenimiento, control y difusión perfecta del calor.

U/C	2	EAN	8436017659856
Diámetro	Capacidad	Altura	
CAZO 16 cm	1,1 litros	7 cm	
CAZUELA 20 cm	2,4 litros	9,5 cm	
CAZUELA 24 cm	4,2 litros	12 cm	



**stonite**  
recubrimiento antiadherente



**Xylan** Plus

Libre de PFOA

## BATERÍA ALUMINIO 4 PIEZAS FULL INDUCTION GRANITE

MOD. BC4

- 4 piezas:
  - Cazuela de 24 cm con tapa.
  - Cazuela de 20 cm con tapa.
  - Cazo de 16 cm.
  - Sartén de 24 cm.
- Fondo difusor inducción total.
- Cuerpo de aluminio forjado.
- Recubrimiento antiadherente Pflon Granite libre de PFOA.
- Base sandwich de 3,5 mm para mantenimiento, control y difusión perfecta del calor.
- Válidas para todo tipo de cocinas, incluida inducción.



**GRANITE**



Libre de PFOA



U/C	2	EAN	8436017659214
Diámetro	Capacidad	Altura	
CAZO 16 cm	1,2 litros	7,5 cm	
CAZUELA 20 cm	2 litros	8 cm	
CAZUELA 24 cm	3,8 litros	10 cm	
SARTÉN 24 CM	-	4,5 cm	

## TREM DE COZINHA FULL INDUCTION MOD. BC3

- 3 peças:
  - Caçarola 24 cm. com tampa.
  - Caçarola 20 cm. com tampa.
  - Caçarola de 16 cm. com tampa.
- Fundo difusor indução total.
- Revestimento antiaderente "Stonite" Xylan® Plus de Whitford isento de PFOA.
- Estruturat de alumínio forjado.
- Base sanduíche de 3 mm. para manutenção, controlo e difusão perfeita do calor.
- Adequadas para todos os tipos de placas, incluindo a de indução.

## TREM DE COZINHA FULL INDUCTION MOD. BC4

- 4 peças:
  - Caçarola 24 cm. com tampa.
  - Caçarola 20 cm. com tampa.
  - Caçarola de 16 cm.
  - Frigideira 24 cm.
- Fundo difusor indução total.
- Estrutura de alumínio forjado.
- Revestimento antiaderente Pflon Granite isento de PFOA.
- Base sanduíche de 3,2 mm para manutenção, controlo e difusão perfeita do calor.
- Adequadas para todos os tipos de placas, incluindo a de indução.

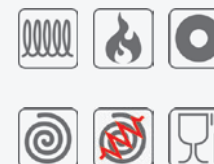



**TREM DE COZINHA**

**MOD. BC8 - BC10**

BC8:

5 peças em aço inoxidável SUS304 com 4 tampas:

- Forma para torta 24 cm.
- Tacho de 22 cm.
- Tacho de 18 cm.
- Caçarola de 16 cm.

BC10:

5 peças em aço inoxidável SUS304 com 5 tampas:

- Forma para torta 26 cm.
- Panela de 24 cm.
- Tacho de 20 cm.
- Tacho de 18 cm.
- Caçarola de 16 cm.

• Base sanduíche para manutenção, controlo e difusão perfeita do calor.

• Asas e pegas em aço inoxidável com proteção de silicone.

• Tampa de vidro de segurança "temperit".

• Adequadas para todos os tipos de placas, incluindo a de indução.

**BATERÍA ACERO INOX AISI-304**

**MOD. BC8 - BC10**

BC8:

4 piezas de acero inoxidable SUS304 con 4 tapas:

- Tartera de 24 cm.
- Cazuela de 22 cm.
- Cazuela de 18 cm.
- Cazo de 16 cm.

BC10:

5 piezas de acero inoxidable SUS304 con 5 tapas:

- Tartera de 26 cm.
- Olla de 24 cm.
- Cazuela de 20 cm.
- Cazuela de 18 cm.
- Cazo de 16 cm.

- Base sandwich para mantenimiento, control y difusión perfecta del calor.
- Asas y pomos en acero inoxidable con protección de silicona.
- Tapa de vidrio de seguridad "temperit".
- Válidas para todo tipo de cocinas, incluida inducción.



Mod. BC8



Mod. BC10

**MOD. BC8**

U/C	2	EAN	8436017659221
-----	---	-----	---------------

Diámetro	Capacidad	Altura
CAZO 16 cm	1,8 litros	9 cm
CAZUELA 18 cm	2,5 litros	10 cm
CAZUELA 22 cm	4,5 litros	12 cm
TARTERA 24 cm	3 litros	6,5 cm

**MOD. BC10**

U/C	2	EAN	8436017659238
-----	---	-----	---------------

Diámetro	Capacidad	Altura
CAZO 16 cm	1,8 litros	9 cm
CAZUELA 18 cm	2,5 litros	10 cm
CAZUELA 20 cm	3,2 litros	11 cm
OLLA 24 cm	6 litros	13 cm
TARTERA 26 cm	3,5 litros	6,5 cm







Acero inoxidable SUS304 3 sistemas de seguridad

## OLLA ACERO INOX A PRESIÓN CLÁSICA

MOD. OPC

- 3 sistemas de seguridad.
- Sistema de cierre progresivo mediante asa giratoria.
- Acero inoxidable SUS304.
- Espesor cuerpo olla 1 mm.
- Base sandwich 5 mm.

### RECAMBIOS ORIGINALES OLLAS OPC

Recambio	Modelo	U/C	EAN
Pomo tapa olla clásica OPC	RPTOPC	1	8436017659009
Válvula control presión olla clásica OPC	RVPOPC	1	8436017659016
Válvula de seguridad olla clásica OPC	RVSOPC	1	8436017659023
Asa cuerpo olla clásica OPC	RACOPC	1	8436017659030
Junta silicona ø 20 cm olla clásica OPC	RJC4	1	8436017657807
Junta silicona ø 22 cm olla clásica OPC	RJC6	1	8436017657814
Junta silicona ø 24 cm olla clásica OPC	RJC8	1	8436017657821
Junta silicona ø 26 cm olla clásica OPC	RJC10	1	8436017657838



Capacidad	Modelo	Diámetro	U/C	EAN
4 litros	OPC4	20 cm	4	8436017657685
6 litros	OPC6	22 cm	4	8436017657692
8 litros	OPC8	24 cm	2	8436017657715
10 litros	OPC10	26 cm	2	8436017657722

## OLLA ACERO INOX RÁPIDA "SECURITY"

MOD. OP

- Alta seguridad.
- Presión 80 Kpa.
- Acero inoxidable SUS304.
- Diámetro 22 cm.
- Espesor cuerpo olla 1,2 mm.
- Base sandwich 5 mm.



Capacidad	Modelo	U/C	EAN
4 litros	OP4	4	8436017657579
6 litros	OP6	4	8436017657586



MOD. OPS46  
Incluye:

- 2 cuerpos de 4 y 6 litros.
- Tapa a presión.
- Tapa de cristal.
- Accesorio cocinado a vapor inox.

U/C 2 SETS EAN 8436017657593



RECAMBIO JUNTA DE SILICONA  
MOD. RJ4 Válido para el modelo OP

U/C 1 EAN 8436017657630

## PANELA DE PRESSÃO CLÁSICA MOD. OPC

- 3 sistemas de segurança.
- Sistema de fecho progressivo através da pega rotativa.
- Aço inoxidável SUS304.
- Espessura da estrutura da panela 1 mm.
- Base em sanduíche 5 mm.

## PANELA DE PRESSÃO "SECURITY" MOD. OP

- Alta segurança.
- Pressão 80 Kpa.
- Aço inoxidável SUS304.
- Diâmetro 22 cm.
- Espessura da estrutura da panela 1,2 mm.
- Base em sanduíche 5 mm.

Recambios  
originales disponibles en  
Opciones de compra:  
[www.jata.es](http://www.jata.es) - [www.jata.pt](http://www.jata.pt)

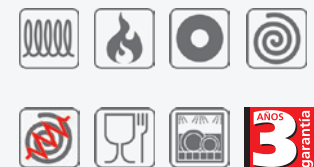





## OLLA ACERO INOX ESTANCA SUPER RÁPIDA

### MOD. OSR

### PANELA SUPER-RÁPIDA

#### MOD. OSR

- 4 dispositivos de segurança.
- Válvula de pressão estanque.
- Silenciosa, segura e com design atraente.
- Garantia máxima.
- Cozinha num terço do tempo das panelas convencionais.
- Aço inoxidável SUS304.
- Vantagens do sistema de cozedura à pressão de vapor:
  - Rápido: até 70 % de poupança em tempo de cozedura.
  - Saudável: preserva as vitaminas e os minerais.
  - Poupança de energia.
- Diâmetro 22 cm.
- Espessura do corpo da panela 1,2 mm.
- Fundo difusor capsulado 5 mm.

- 4 dispositivos de seguridad.
- Válvula de presión estanca.
- Silenciosa, segura y atractivo diseño.
- Máxima garantía.
- Cocina en un tercio menos de tiempo que otras ollas convencionales.
- Acero inoxidable SUS304.
- Diámetro 22 cm.
- Espesor cuerpo olla 1,2 mm.
- Fondo difusor capsulado 5 mm.
- Ventajas del sistema de cocción a presión de vapor:
  - Rápido: hasta un 70% de ahorro en el tiempo de cocción.
  - Sano: conserva vitaminas y minerales.
  - Ahorro de energía.

Capacidad	Modelo	U/C	EAN
4 litros	OSR4	1	8436017658255
6 litros	OSR6	1	8436017658262
8 litros	OSR8	1	8436017658279

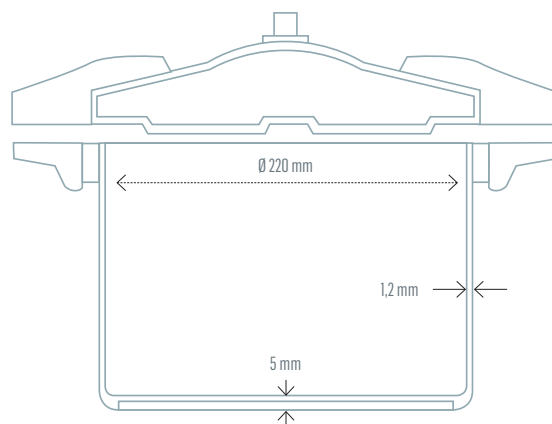

Recambios originales disponibles en  
Opciones de compra:  
[www.jata.es](http://www.jata.es) - [www.jata.pt](http://www.jata.pt)

### RECAMBIOS ORIGINALES OLLAS OSR

Recambio	Modelo	U/C	EAN
Asa cuerpo olla estancia OSR	RACOSR	1	8436017658941
Asa tapa olla olla estancia OSR	RATOSR	1	8436017658958
Junta de silicona 22 cm olla estancia OSR	RJSOSR	1	8436017658965
Válvula de cierre olla estancia OSR	RVCOSR	1	8436017658972
Válvula de sobre presión olla estancia OSR	RVPOSR	1	8436017658989
Válvula estanca olla estancia OSR	RVEOSR	1	8436017658996





NOVEDAD

OTOÑO



## CAFETERA ITALIANA FULL INDUCTION

MOD. CFI

- Fondo difusor inducción total.
- Tratamiento interior especial antióxido.
- Interior pulido.
- Cuerpo de aluminio.
- Junta de silicona.



Capacidad	Modelo	U/C	EAN
6 tazas	CFI6	6	8436017659825
9 tazas	CFI9	6	8436017659832
12 tazas	CFI12	6	8436017659849

## CAFETERA ITALIANA ALUMINIO

MOD. CCA

- Tratamiento interior especial antióxido.
- Interior pulido.
- Junta de silicona.
- Cuerpo de aluminio.
- Apta para cocinas de gas, eléctricas, vitrocerámica, halógenas.



Capacidad	Modelo	U/C	EAN
3 tazas	CCA3	12	8436017658583
6 tazas	CCA6	12	8436017658590
9 tazas	CCA9	12	8436017658606
12 tazas	CCA12	6	8436017658613

NOVEDAD

PRIMAVERA



## CAFETEIRA ITALIANA FULL INDUCTION MOD. CFI

- Fundo difusor indução total.
- Tratamiento interior especial antiferrugem.
- Interior polido.
- Estrutura em alumínio.
- Junta de silicone.

## CAFETEIRA ITALIANA MOD. CCA

- Tratamiento interior especial antiferrugem.
- Interior polido.
- Junta de silicone.
- Estrutura em alumínio.
- Preparada para fogões a gás, electricidade, vitrocerâmica, halógenas.





## CAFETERA EXPRÉS ACERO INOX INDUCCIÓN *Odin*

MOD. CAX1

- Tratamiento interior "Sand Blaster" en caldera y cuerpo superior, especial antióxido.
- Fabricada en acero inoxidable.
- Acabado pulido espejo.



Capacidad	Modelo	U/C	EAN
4 tazas	CAX104	6	8436017658163
6 tazas	CAX106	6	8436017658170
10 tazas	CAX110	6	8436017658187
12 tazas	CAX112	6	8436017659436

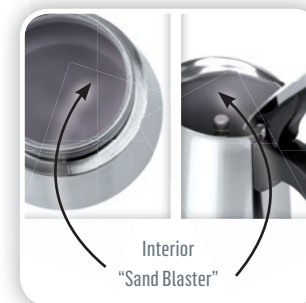

## CAFETEIRA ITALIANA INOX "ODIN" MOD. CAX1

- Fabricada em aço inoxidável.
- Tratamento interior "Sand Blaster" em caldeira e corpo superior, especial anti-oxidação.
- Acabamento polido espelho.

## CAFETEIRA ITALIANA INOX MOD. CAX

- Fabricada em aço inoxidável.
- Tratamento interior "Sand Blaster" em caldeira e corpo superior, especial anti-oxidação.
- Acabamento polido espelho.



## CAFETERA EXPRÉS ACERO INOX INDUCCIÓN

MOD. CAX

- Tratamiento interior "Sand Blaster" en caldera y cuerpo superior, especial antióxido.
- Fabricada en acero inoxidable.
- Acabado pulido espejo.



Capacidad	Modelo	U/C	EAN
4 tazas	CAX4	6	8436017657357
6 tazas	CAX6	6	8436017657371
9 tazas	CAX9	6	8436017657395





MOD. JH03

3,5 L	2L
Capacidad Total	Capacidad Agua Filtrada

MOD. JH01

2,5 L	1,5L
Capacidad Total	Capacidad Agua Filtrada

## JARRA PURIFICADORA DE AGUA

MOD. JH01 - JH03

- Filtro exclusivo JATA HOGAR.
- Filtro iónico.
- Mejora la calidad y el sabor del agua manteniendo los minerales esenciales.
- Reduce el cloro hasta un 80%.
- Reduce la cal hasta un 95%.
- Reduce residuos de cobre hasta un 50%.
- Mantiene el pH del agua entre 7-8.
- 150-180 litros de filtrado ó 30-45 días.
- Indicador manual de control del filtro.
- Diseño apto para la puerta del frigorífico.
- Base anti-deslizante.
- Asa ergonómica.



Capacidad	Modelo	U/C	EAN
2,5 L	JH01	6	8436017654080
3,5 L	JH03	6	8436017654127



## JARRO PURIFICADOR DE ÁGUA MOD. JH01 - JH03

- Filtro exclusivo JATA HOGAR.
- Filtro de iões.
- Melhora a qualidade e o sabor da água mantendo os minerais essenciais.
- Reduz o cloro até 80%.
- Reduz a cal até 95%.
- Reduz resíduos de cobre até 50%.
- Mantém o pH da água entre 7 - 8.
- 150 - 180 litros de filtragem ou 30 - 45 dias.
- Indicador manual de controlo do filtro.
- Modelo adaptado para a porta do frigorífico.
- Base com antideslizamento.
- Pega ergonómica.

Filtros iónicos disponibles  
Opciones de compra:  
[www.jata.es](http://www.jata.es) - [www.jata.pt](http://www.jata.pt)



REF. RE123X4  
Pack 4 unidades

U/C	6	EAN	8436017654523
-----	---	-----	---------------



REF. REC07X3  
Pack 3 unidades

U/C	8	EAN	5060090240156
-----	---	-----	---------------







# ALACENA



ACCESORIOS ..... 38



BOLSAS PORTA ALIMENTOS ..... 42



TERMOS ..... 38



MOLDES ..... 46



PORTA ALIMENTOS ..... 41



### SET ACCESORIOS NYLON COCINA 7+1

MOD. AC7

- Mango ergonómico.
- Higiénico y saludable, cumple normativa FDA y LFGB.
- Resistencia al calor más de 200 °C.

U/C 8 EAN 8436017659085



### SET UTENSILIOS NYLON COCINA 6 PIEZAS

MOD. AC6

- Mango ergonómico de silicona TPR antideslizante.
- Higiénico y saludable, cumple normativa FDA.
- Resistencia al calor más de 200 °C.
- Soporte de mesa incluido.

U/C 6 EAN 8436017659665

**NOVEDAD**  
**OTOÑO**



### FIAMBREIRA TERMO SÓLIDOS

MOD. 942 - 943



- Doble pared aislante, para conservar mejor los alimentos fríos o calientes durante horas.
- Libre de BPA.
- Higiénico y saludable, cumple normativa FDA.
- Incluye recipiente interior de un 1 litro.
- Apto para microondas.
- Asa de transporte.

Capacidad	Modelo	Altura	Diámetro	U/C	EAN
2 litros	942	13,4 cm	21,4 cm	6	8436017658781
3 litros	943	17,4 cm	21,4 cm	6	8436017658798

Incluye recipiente de un 1 litro. Apto para microondas.

### CONJUNTO UTENSÍLIOS DE COZINHA MOD. AC7

- Utensílios de cozinha de nylon 7 + 1.
  - Espátula.
  - Colher para massa.
  - Concha.
  - Escumadeira.
  - Pega ergonómica.
  - Higiénico e saudável, de acordo com a norma FDA e LFGB.
  - Resistência ao calor acima de 200 °C.
- Caçarola.
- 1 espátula
- 1 espátula ranhurada
- Pinças para servir.

### CONJUNTO UTENSÍLIOS DE COZINHA MOD. AC6

- Utensílios de cozinha de nylon.
  - Colher para massa.
  - Concha.
  - Escumadeira.
  - Pega ergonómica de silicone TPR antideslizante.
  - Higiénico e saudável, de acordo com a norma FDA.
  - Resistência ao calor acima de 200 °C.
  - Suporte de mesa incluído.
- Caçarola.
- Espátula.
- Espátula ranhurada.

### FIAMBREIRA MOD. 942 - 943

- Parede dupla isolante para conservar melhor a comida quente ou fria durante horas.
- Isento de BPA.
- Higiénico e saudável, de acordo com a norma FDA.
- Inclui recipiente de 1 litro. Adequado para microondas.
- Pega de transporte.



**TERMO INOX  
MOD. 834**

- Parede dupla de aço inoxidável de alta qualidade:
  - Interior: aço inox 304.
  - Exterior: aço inox 201.
- Isento de BPA.
- Isolamento térmico. Conserva as bebidas frias ou quentes durante várias horas.
- Tampa de rosca. Fecho hermético.
- Leves e fáceis de transportar.

**TERMO INOX  
MOD. 835 - 836 - 837 - 838**

- Parede dupla de aço inoxidável de alta qualidade.
- Isento de BPA.
- Silicone na base e zona de manuseamento antiderrapante.
- Grande resistência a impactos e quedas.

**TERMO PESSOAL DE VIAGEM  
MOD. 840**

- Parede dupla de aço inoxidável de alta qualidade:
  - Interior: aço inox 304.
  - Exterior: aço inox 201.
- Isento de BPA.
- Isolamento térmico. Conserva as bebidas frias ou quentes durante várias horas.
- Tampa de rosca. Fecho hermético.
- Leves e fáceis de transportar.

**TERMO INOX  
MOD. 825 - 827**

- Parede dupla de aço inoxidável de alta qualidade.
- Isento de BPA.
- Silicone na base e zona de manuseamento antiderrapante.
- Grande resistência a impactos e quedas.

**TERMO *inox***

MOD. 834

**NOVE  
DAD**  
OTOÑO

- Doble pared de acero inoxidable de alta calidad:
  - Interior: acero inox 304.
  - Exterior: acero inox 201.
- Libre de BPA.
- Aislamiento térmico. Conserva las bebidas frías o calientes durante varias horas.
- tapa rosca.
- Ligero y fácil de transportar.

**200  
ml**



Expositor de 12 unidades  
24,8 x 18, 3 x 15 cm

U/C 12 (1 exp.) EAN 8436017659696



Vertedor  
apertura

Cierre  
rápido

**TERMO LÍQUIDOS "EXCLUSIVE" *inox***

MOD. 835 - 836 - 837 - 838

- Doble pared de acero inoxidable de alta calidad.
- Libre de BPA.
- Silicona en base y zona de agarre antideslizante.
- Gran resistencia a golpes y caídas.

Capacidad	Modelo	U/C	EAN
350 ml	835	6	8436017658507
500 ml	836	6	8436017658514
750 ml	837	6	8436017658521
1 litro	838	6	8436017658538

**TERMO PERSONAL DE VIAJE *inox***

MOD. 840

**NOVE  
DAD**  
OTOÑO

- Doble pared de acero inoxidable de alta calidad:
  - Interior: acero inox 304.
  - Exterior: acero inox 201.
- Libre de BPA.
- Aislamiento térmico. Conserva las bebidas frías o calientes durante varias horas.
- Tapa rosca.
- Ligero y fácil de transportar.

**350  
ml**



Asa abatible  
para colgar



Pulsador  
apertura

Cierre  
hermético

U/C 6 EAN 8436017659702



Mod. 825

Mod 827



Tapa interior con válvula descompresora  
para facilitar la apertura

**TERMO SÓLIDOS "EXCLUSIVE" *inox***

MOD. 825-827

- Doble pared de acero inoxidable de alta calidad.
- Libre de BPA.
- Silicona en base y zona de agarre antideslizante.
- Gran resistencia a golpes y caídas.

Capacidad	Modelo	U/C	EAN
500 ml	825	6	8436017658866
750 ml	827	6	8436017658873





## TERMO LÍQUIDOS 1 LITRO *inox*

MOD. 917

- Doble pared de acero inoxidable de alta calidad.
- Libre de BPA.
- Gran resistencia a golpes y caídas.



Vertedor  
apertura

Cierre  
rápido

Disponible en 2 colores	U/C	EAN
Mod. 917A	6	8436017657197
Mod. 917G	6	8436017657210

## TERMO LÍQUIDOS GRIS-VERDE *inox*

MOD. 909 - 918 - 919 - 920

- Doble pared de acero inoxidable de alta calidad.
- Libre de BPA.
- Gran resistencia a golpes y caídas.

Capacidad	Modelo	U/C	EAN
350 ml	909	6 (1 exp.)	8436017658040
500 ml	918	6 (1 exp.)	8436017657746
750 ml	919	6 (1 exp.)	8436017658057
1 litro	920	6 (1 exp.)	8436017658064



Vertedor  
apertura

Cierre  
rápido



Expositor de 6 unidades

## JARRA TAZA ANTICAÍDA CON TAPA 400 ML *Magic*

MOD. 950

- Sistema especial ventosa anticaída.
- Apto para superficies planas, no porosas.
- Doble pared, aislamiento óptimo.
- Interior de acero inox.
- Libre de BPA.
- Capacidad 400 ml.
- Con tapa y asa.
- Modelo de utilidad registrado.



Sistema especial  
ventosa anticaída

Con tapa y asa



Expositor de 6 unidades  
39 x 14 x 29 cm



U/C	6 (1 exp.)	EAN	8436017658101
-----	------------	-----	---------------

## TERMO INOX MOD. 917

- Pared dupla de aço inoxidável de alta qualidade.
- Isento de BPA.
- Grande resistência a impactos e quedas.

## TERMO INOX MOD. 909 - 918 - 919 - 920

- Pared dupla de aço inoxidável de alta qualidade.
- Isento de BPA.
- Grande resistência a impactos e quedas.

## JARRO - CHÁVENA MAGIC MOD. 950

- Sistema especial ventosa anti-queda.
- Indicado para superficies lisas, não porosas.
- Pared dupla, isolamento ótimo.
- Interior em aço inoxidável.
- Isento de BPA.
- Capacidade 400 ml.
- Com tampa e asa.
- Modelo de Utilidade registrado.







### RECIPIENTES DE VIDRO TEMPERADO

#### MOD. RC

- Recipientes de vidro temperado.
- Permitem conservar os alimentos saudáveis e de forma higiénica.
- Isentos de BPA.
- Adequados para o forno, o congelador, o microondas e a máquina de lavar louça.
- Herméticos, sem mistura de odores ou sabores.
- Adequados para alimentos sólidos e líquidos.
- Tampa com válvula para facilitar a abertura.

### SET FIAMBRERAS VIDRIO TEMPLADO

#### MOD. RC

- Permiten conservar los alimentos de forma sana e higiénica.
- Libres de BPA.
- Recipientes aptos para el horno, congelador, microondas y lavavajillas.
- Herméticos, sin mezcla de olores ni sabores.
- Aptos para alimentos sólidos y líquidos.
- Tapa con válvula para facilitar la apertura.

Modelo	Recipientes	Medidas	Altura	Capacidad	U/C	EAN
RC50	3	Ø 12,3 cm	5,5 cm	390 ml	6	8436017659122
		Ø 14,3 cm	6,0 cm	600 ml		
		Ø 16,3 cm	6,5 cm	880 ml		
RC51	2	12 x 12 cm	5,5 cm	430 ml	6	8436017659139
		15,5 x 15,5 cm	6,5 cm	900 ml		
RC52	2	14,3 x 9,5 cm	5,5 cm	400 ml	6	8436017659146
		18,3 x 12,5 cm	6,5 cm	830 ml		



### PORTA ALIMENTOS DE SILICONE DOBRÁVEL

#### MOD. 903 - 905

- Dobrável, arruma-se num espaço mínimo.
- Higiénico e saudável, de acordo com a norma LFGB.
- Isento de BPA.
- Adequado para alimentos sólidos.
- Apto para microondas +120° C y congelador -40° C.

### PORTA ALIMENTOS SILICONA PLEGABLE

#### MOD. 903 - 905

- Plegable, mínimo espacio de almacenaje.
- Higiénico y saludable, cumple normativa LFGB.
- Libre de BPA.
- Apto para alimentos sólidos.
- Apto para microondas +120° C y congelador -40° C.



Capacidad	Modelo	U/C	EAN
540 ml	903	24 (1 exp.)	8436017657074
750 ml	905	24 (1 exp.)	8436017657098

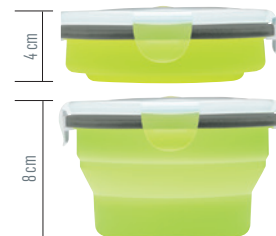

**BOLSA PORTA ALIMENTOS TAKE AWAY**



MOD. 910N

- Bolsa porta alimentos flexible con aislante térmico.
- Interior de PEVA: material plástico aislante, respetuoso del medio ambiente y libre de tóxicos. Anti-bacterias. Fácil limpieza.
- Higiénico y saludable, cumple normativas EU10/2011 y EN71-3.
- Libre de BPA. Compartimento y rejilla interior.
- 2 contenedores herméticos Clic tite® fácil apertura Easy Clips®.
- Aptos para microondas +120 °C y congelador -18 °C.

U/C 6 EAN 8436017658828



**BOLSA TÉRMICA PORTA ALIMENTOS BASICA TAKE AWAY**

MOD. 951

- Interior de lámina de aluminio: material aislante, respetuoso del medio ambiente y libre de tóxicos. Antibacterias. Fácil limpieza.
- Higiénico y saludable, cumple normativa FDA. Libre de BPA.
- 2 compartimentos exteriores.
- 2 contenedores herméticos.
- Aptos para líquidos, sólidos, microondas +120 °C y congelador -18 °C.

U/C 6 EAN 8436017658705



2 x 1.100 ml  
Capacidad total 2.200 ml



22 x 20 x 16 cm

**BOLSA TÉRMICA PORTA ALIMENTOS TAPA BASE RIGIDA TAKE AWAY**

MOD. 952

- Interior de lámina de aluminio: material aislante, respetuoso del medio ambiente y libre de tóxicos.
- Antibacterias. Fácil limpieza.
- Higiénico y saludable, cumple normativa FDA.
- Libre de BPA.
- Compartimento de rejilla interior.

U/C 6 (1 exp.) EAN 8436017658804



22 x 16 x 16 cm



Expositor de 6 unidades  
27 x 49 x 17,5 cm

**BOLSA TÉRMICA PORTA ALIMENTOS EXTENSIBLE 8 CM TAKE AWAY**

MOD. 954

- Interior de lámina de aluminio: material aislante, respetuoso del medio ambiente y libre de tóxicos.
- Antibacterias. Fácil limpieza.
- Higiénico y saludable, cumple normativa FDA. Libre de BPA.
- Compartimento superior extensible hasta 8 cm.
- 3 bolsillos exteriores. 2 contenedores herméticos "Airtight".
- Aptos para líquidos, sólidos, microondas +120 °C y congelador -18 °C.

U/C 6 EAN 8436017658774



1.100 ml

1.500 ml

23 x 15 x 22 cm

Extensible hasta 8 cm

**GELEIRAS TAKE AWAY**

MOD. 910N - 951 - 952 - 954

- Respeita o meio ambiente e livre de agentes tóxicos.
- Anti-bactérias. Fácil de limpar.
- Higiénico e saudável, Isento de BPA

MOD. 910N

- Geleira flexível com isolamento térmico.
- Interior em PEVA: material plástico isolante.
- De acordo com a normas EU10/2011 e EN71-3. Compartimento e malha interior.
- 2 caixas herméticas Clic tite® abertura fácil Easy Clips®. Podem usar-se em microondas +120 °C e congelador -18 °C.

MOD. 951

- Interior em lâmina de alumínio: material isolante.
- De acordo com a norma FDA.
- 2 compartimentos externos.
- 2 caixas herméticas de abertura fácil.
- Adequado para sólidos e líquidos, microondas +120 °C e congelador -18 °C.

MOD. 952

- Interior em lâmina de alumínio: material isolante.
- De acordo com a norma FDA.
- Compartimento interior de malha.

MOD. 954

- Interior em lâmina de alumínio: material isolante Thermo-Flect® Ultra safe™.
- Higiénico e saudável, de acordo com a norma FDA.
- Compartimento superior extensível até 8 cm.
- 3 bolsos exteriores. 2 caixas herméticas "Airtight". Adequado para sólidos e líquidos.
- Podem usar-se em microondas +120 °C e congelador -18 °C.





## GELEIRA TAKE AWAY MOD. 970

- Geleira flexível.
- Interior em lâmina de alumínio: material isolante, que respeita o ambiente e livre de agentes tóxicos. Anti-bactérias. Fácil de limpar.
- Isento de BPA.
- Abertura na tampa para fácil acesso.
- Higiénico e saudável, de acordo com a norma FDA.
- 3 compartimentos externos.

## GELEIRA TAKE AWAY MOD. 980

- Geleira flexível.
- Interior em lâmina de alumínio: material isolante, que respeita o ambiente e livre de agentes tóxicos. Anti-bactérias. Fácil de limpar.
- Higiénico e saudável, de acordo com a norma FDA. Isento de BPA.
- 3 compartimentos externos. Compartimento interior.
- Fita elástica ajustável.

## TROLLEY MALA TÉRMICA PORTA ALIMENTOS MOD. 990

- Geleira flexível.
- Alsa extensível.
- Interior em lâmina de alumínio: material isolante, que respeita o ambiente e livre de agentes tóxicos. Anti-bactérias. Fácil de limpar.
- Abertura na tampa para fácil acesso.
- Modelo moderno e elegante, com pega de mão e rodas tamanho grande.
- Higiénico e saudável, de acordo com a norma FDA. Isento de BPA.
- Compartimento exterior.



## BOLSA TÉRMICA NEVERA PORTA ALIMENTOS TAKE AWAY

MOD. 970

- Flexible.
- Interior de lámina de aluminio: material aislante, respetuoso del medio ambiente y libre de tóxicos. Antibacterias. Fácil limpieza.
- Apertura en la tapa para fácil acceso.
- Higiénico y saludable, cumple normativa FDA, Libre de BPA.
- 3 bolsillos exteriores.

U/C 6 EAN 8436017658750



19,5 Litros

32 x 26 x 34 cm

NOVE DAD  
PRIMAVERA

Cinta elástica ajustable.



## TROLLEY TÉRMICO NEVERA PORTA ALIMENTOS TAKE AWAY

MOD. 990

- Flexible.
- Asa extensible.
- Interior de lámina de aluminio: material aislante, respetuoso con el medio ambiente y libre de tóxicos.
- Antibacterias. Fácil limpieza.
- Apertura en la tapa para fácil acceso.
- Diseño moderno y elegante, con asa y ruedas de gran tamaño
- Higiénico y saludable, cumple normativa FDA.
- Libre de BPA.
- Compartimento exterior.

U/C 4 EAN 8436017659368



NOVE DAD  
PRIMAVERA



23 Litros

30 x 30 x 41 cm

15 Litros

Apertura en la tapa para fácil acceso



31 x 24 x 22 cm

## BOLSA TÉRMICA NEVERA PORTA ALIMENTOS TAKE AWAY

MOD. 980

- Flexible.
- Interior de lámina de aluminio: material aislante, respetuoso con el medio ambiente y libre de tóxicos. Antibacterias. Fácil limpieza.
- Higiénico y saludable, cumple normativa FDA. Libre de BPA.
- 3 bolsillos exteriores. Compartimento interior.
- Cinta elástica ajustable.

U/C 6 EAN 8436017659375



Gran tamaño

Asa extensible

Apertura en la tapa para fácil acceso







## BOLSAS TROLLEY PLEGABLE



MOD. 992

**NOVE DAD**  
OTOÑO



- Bolsa trolley plegable compacta con asa de transporte.
- Capacidad 30 L.
- Interior de lámina de aluminio: material aislante, respetuoso del medio ambiente y libre de tóxicos. Antibacterias. Fácil limpieza.
- Material exterior de poliéster extra resistente, libre de AZO (colorante textil sin elementos químicos).
- Ruedas plegables extra resistentes.
- Soporta hasta 15 kg.
- Asa de transporte.

MOD. 992 - 994

### MOD. 992

- Compartimento principal con cremallera.
- Bolsillo exterior.

### MOD. 994

- Compartimento principal con clip de cierre.
- Compartimento exterior con bolsillo.



Ruedas plegables extra resistentes



Interior de aluminio



Asa de transporte  
Soporta hasta 15 kilos



MOD. 994



**LIBRE DE AZO**  
colorante textil sin  
elementos químicos



Mod. 992	U/C	6 (1 exp.)	EAN	8436017659641
Mod. 994	U/C	6 (1 exp.)	EAN	8436017659634



Mod. 992  
Expositor de 6 unidades  
47 x 36 x 23 cm



Mod. 994  
Expositor de 6 unidades  
47 x 36 x 23 cm

## SACOS TROLLEY DOBRÁVEL MOD. 992 - 994

- Saco trolley dobrável compacto com pega de transporte.
- Capacidade 30 L.
- Interior em lâmina de alumínio: material isolante, que respeita o ambiente e livre de agentes tóxicos. Antibactérias. Fácil de limpar.
- Material exterior de poliéster extra resistente, isento de AZO (corante têxtil sem elementos químicos).
- Rodas dobráveis extra resistentes.
- Suporta até 15 kg.
- Pega de transporte.

### MOD. 992

- Compartimento principal com fecho de correr.
- Bolso exterior.

### MOD. 994

- Compartimento principal com fecho de correr.
- Compartimento exterior com bolso.







## SACO ISOTÉRMICO PARA ALIMENTOS COM REFRIGERANTE INTEGRADO MOD. 926 - 927 - 928

- Saco isotérmico para guardar alimentos com gel refrigerante integrado.
- Direta para o congelador. Totalmente dobrável.
- Mantém a mesma temperatura durante horas.
- Interior em lâmina de alumínio: material isolante, que respeita o ambiente e livre de agentes tóxicos.
- Anti-bactérias. Fácil de limpar.
- Higiénico e saudável, de acordo com a norma FDA. Isento de BPA.
- Com alça de ombro para fácil transporte. Compartimento externo.
- Fácil de armazenar, totalmente dobrável.

## SACO ISOTÉRMICO PARA GARRAFAS COM REFRIGERANTE INTEGRADO MOD. 923

- Direta para o congelador. Totalmente dobrável.
- Especial garrafas e latas.
- Mantém a mesma temperatura durante horas.
- Interior em lâmina de alumínio: material isolante, que respeita o ambiente e livre de agentes tóxicos.
- Anti-bactérias. Fácil de limpar.
- Higiénico e saudável, de acordo com a norma FDA.
- Isento de BPA.
- Com pega e alça de ombro para fácil transporte.
- Compartimento externo.
- Fácil de armazenar, totalmente dobrável.
- Adequado para 1 garrafa de 2 litros, na vertical.



## BOLSA NEVERA REFRIGERANTE INTEGRADO TAKE AWAY

MOD. 926 - 927 - 928

- Bolsa nevera porta alimentos con gel refrigerante integrado.
- Directa al congelador. Totalmente plegable.
- Mantiene la misma temperatura durante horas.
- Interior de lámina de aluminio: material aislante, respetuoso con el medio ambiente y libre de tóxicos.
- Antibacterias. Fácil limpieza.
- Higiénico y saludable, cumple normativa FDA. Libre de BPA.
- Con bandolera para su fácil transporte. Compartimento exterior.
- Fácil de almacenar, totalmente plegable.

Modelo	Medidas	Capacidad	U/C	EAN
926	22 x 14 x 17 cm	5 L	6 (1 exp.)	8436017659399
927	25 x 14 x 26 cm	8 L	6 (1 exp.)	8436017659405
928	25 x 22 x 27 cm	12 L	6 (1 exp.)	8436017659412



Expositor de 6 unidades



**NOVE DAD**  
PRIMAVERA

*¡Olvidate de acumuladores!*



Directa al congelador.  
Totalmente plegable.



**2 Litros**

*¡Olvidate de acumuladores!*



Directa al congelador.  
Totalmente plegable.



Expositor de 6 unidades  
30 x 20 x 22 cm



## BOLSA NEVERA REFRIGERANTE INTEGRAL BOTELLA TAKE AWAY

MOD. 923

- Directa al congelador. Totalmente plegable.
- Especial botellas y latas.
- Mantiene la misma temperatura durante horas.
- Interior de lámina de aluminio: material aislante, respetuoso con el medio ambiente y libre de tóxicos.
- Antibacterias. Fácil limpieza.
- Higiénico y saludable, cumple normativa FDA.
- Libre de BPA.
- Con asa y bandolera para su fácil transporte.
- Compartimento exterior.
- Fácil de almacenar, totalmente plegable.
- Apta para 1 botella de 2 litros verticalmente.

**NOVE DAD**  
PRIMAVERA

Diámetro	Medidas	Capacidad	U/C	EAN
14 cm	37 cm	2 L	6 (1 exp.)	8436017659382



## MOLDES DE COCINA

### MOD. MC

- Molde de silicona platino, antiadherente, flexible y fácil de desmoldar.
- Libre de BPA.
- Cocción uniforme.
- Aptos para el horno, congelador, microondas y lavavajillas.
- Resistente a temperaturas extremas: hasta 240 °C y 50 °C bajo cero.

Modelo	Medidas	Altura	Usos	U/C	EAN
MC60	Ø 26 cm	3 cm	Especial tartas	6	8436017659153
MC61	Ø 21 cm	10 cm	Especial roscón	6	8436017659160
MC62	6 cavidades de: Ø 6 cm	3 cm	Para muffins, magdalenas	6	8436017659177
MC63	Rectangular: 24 x 10 cm	6,5 cm	Repostería y cocina	6	8436017659184
MC64	20 x 19 cm	4,5 cm	Repostería y cocina	6	8436017659191
MC65	Ø 23 cm	6 cm	Repostería y cocina	6	8436017659207
MC66	24 x 13 cm	5,5 cm	Especial papillote y cocina al vapor	6	8436017659528
MC67	6 flaneras de Ø 7,5 cm	5,5 cm	Para flanes, natillas	6	8436017659535
MC68	23 x 18 cm	4,5 cm	Repostería y cocina	6	8436017659542

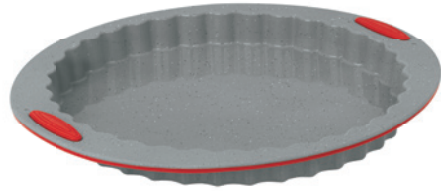

Mod. MC60

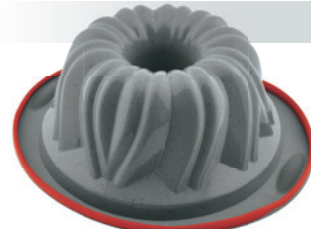

Mod. MC61



Mod. MC62



Mod. MC63



Mod. MC64



Mod. MC65

**NOVE  
DAD**  
PRIMAVERA



Mod. MC66



Mod. MC67



Mod. MC68

## FORMAS DE COZINHA MOD. MC

- Forma de silicone platino, antiaderente, flexível e fácil de desenformar.
- Isento de BPA.
- Cozinha uniformemente.
- Adequadas para o forno, o congelador, o microondas e a máquina de lavar louça.
- Resistente a temperaturas extremas: entre 240 °C e - 50 °C.





# PLANCHA



ESCALERAS MULTIFUNCIÓN ..... 48



PLANCHA FÁCIL ..... 48



TABLAS DE PLANCHAR ..... 49





**TABLA DE PLANCHAR / ESCALERA MULTIFUNCIÓN**



MOD. 848N - 848S

- Fácil conversión escalera / tabla de planchar.
- Funda de algodón 100%.
- Acorde con la norma EN131-2.
- Escalera de 3 peldaños, gran estabilidad. Altura 70 cm.
- Escalera sin tornillos ni fijaciones.

**MOD. 848N**

- Reposo planchas de acero inoxidable, apto para centros de planchado. Medidas 32 x 21 cm.
- Acabado metalizado. Alta resistencia a la oxidación.

**MOD. 848S**

- Superficie de planchado: 107 x 34 cm. Altura tabla de planchar: 85 cm.
- Reposo planchas especial para centros de planchado, con barandilla de seguridad de 32 x 21 cm.



Mod. 848N	U/C	2	EAN	8436017651966
Mod. 848S	U/C	2	EAN	8436017653335



**RECAMBIO FUNDA Y MULETÓN - FUNDA DE ALGODÓN 100% (espesor del muletón de felpa 5 mm)**

Válido para	Modelo	U/C	EAN
Mod. 848N	RF8N	6	8436017658569
Mod. 848S	RF8S	6	8436017658576

Opciones de compra:  
[www.jata.es](http://www.jata.es) - [www.jata.pt](http://www.jata.pt)



**PLANCHA FÁCIL TEFLÓN**

MOD. 800



- Espesor 0,55 mm. Uso universal.
- El Plancha Fácil de Jata Hogar permite planchar sin fatiga, más rápido y sin dejar brillos en tejidos delicados.
- Se adapta a todas las planchas del mercado.
- Está fabricado con material antiadherente resistente a temperaturas de hasta 250 °C.
- Resbala suavemente sobre los tejidos evitando rozamientos brillos y chamuscados.

U/C	24	EAN	8436017650785
-----	----	-----	---------------

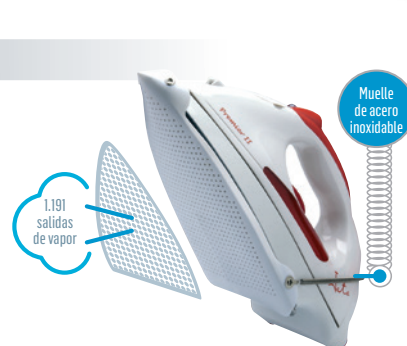

**ESCADOTE / TÁBUA DE ENGOMAR MOD. 848N - 848S**

- Fácil transformação de escadote / tábu de engomar.
- Protecção em 100% algodão.
- Conforme a norma EN131-2.
- Escadote de 3 degraus, grande estabilidade. Altura 70 cm

**MOD. 848N**

- Superfície para engomar: 95 x 34 cm. Altura tábu de engomar: 83 cm.
- Reposo ferro preparado para centros de engomagem, medidas 32 x 21 cm.
- Acabamento metalizado, alta resistência à oxidação.

**MOD. 848S**

- Superfície para engomar: 107 x 34 cm. Altura tábu de engomar: 85 cm.
- Reposo ferro preparado para centros de engomagem com sistema de segurança de 32 x 21 cm.

**ENGOMA FACIL MOD. 800**

- O "engoma fácil" que permite engomar sem fadiga, mais rapidamente e sem deixar lustro nos tecidos delicados.
- É fabricado em material anti-aderente resistente a temperaturas até 250 °C.
- Adapta-se a todas as ferro de engomar do mercado.
- Foi concebido para repartir homogeneamente o vapor gerado pelo ferro de engomar.
- Modelo universal.





## TÁBUA DE ENGOMAR "VITAL" MOD. TP500

- Superfície para engomar 116 x 35 cm
- Estrutura termolacada. Alta resistência à oxidação.
- Tábua de engomar ergonómica em rede.
- Altura regulável multiposições até 90 cm.
- Modelo de pernas em "Y", de elevada estabilidade.
- Local para repouso do ferro de engomar. Medidas 29 x 20 cm.

## TÁBUA DE ENGOMAR "COMPACT" MOD. TP520

- Superfície para engomar 124 x 40 cm
- Estrutura termolacada. Alta resistência à oxidação.
- Tábua de engomar ergonómica de metal expandido.
- Altura regulável multiposições até 93 cm.
- Modelo de pernas em "Y", de elevada estabilidade.
- Local para repouso adequado para ferros com caldeira. Medidas 44 x 27 cm

## TÁBUA DE ENGOMAR MANGAS DOBRÁVEL MOD. TM200

- Superfície para engomar 50 x 10 cm.
- Estrutura termolacada. Alta resistência à oxidação.
- Cobertura de algodão 100% com moletão.

## TABLA PLANCHAR "VITAL" MORADA DEGRADADO 116X35

### MOD. TP500

- Plataforma ergonómica en red.
- Altura ajustable multiposiciones hasta 90 cm.
- Estructura termolacada. Alta resistencia a la oxidación.
- Superficie de planchado 116 x 35 cm.
- Reposo planchas. Medidas 29 x 20 cm.
- Medidas plegada 137 x 35 x 6 cm.
- Diseño de patas en "Y", alta estabilidad.

## TABLA DE PLANCHAR NEGRA LINEAS "COMPACT" 123X40

### MOD. TP520

- Plataforma ergonómica en metal desplegado.
- Altura ajustable multiposiciones hasta 93 cm.
- Estructura termolacada. Alta resistencia a la oxidación.
- Superficie de planchado 123 x 40 cm.
- Reposo planchas apto para centros de planchado. Medidas 44 x 27 cm.
- Diseño de patas en "Y", alta estabilidad.



### RECAMBIO FUNDA Y MULETÓN

Con una elevada resistencia a altas temperaturas y gracias a su superficie acolchada con muletón, la funda JATA HOGAR facilita el planchado, reduciendo cerca del 20% tanto el tiempo como el esfuerzo empleado.



Válido para	Modelo	U/C	EAN
Mod. TP500	RF50	6	8436017659290
Mod. TP520	RF52	6	8436017659306

Opciones de compra:  
[www.jata.es](http://www.jata.es) - [www.jata.pt](http://www.jata.pt)

Mod. TP500	U/C	2	EAN	8436017659245
Mod. TP520	U/C	2	EAN	8436017659252



## PLANCHA MANGAS NEGRO PLEGABLE 50X10 CM

### MOD. TM200

- Superficie de planchado 50 x 10 cm.
- Estructura termolacada. Alta resistencia a la oxidación.
- Funda de algodón 100% con moletón.

U/C	6	EAN	8436017659320
-----	---	-----	---------------



Plegable para fácil almacenamiento





## TABLA DE PLANCHAR NEGRA LOGO "SUPREMA" 130X47

MOD. TP550

- Superficie de planchado 130 x 47 cm.
- Estructura termolacada. Alta resistencia a la oxidación.
- Plataforma ergonómica en metal desplegado.
- Altura ajustable multiposiciones hasta 95 cm.
- Diseño de patas en "Y", alta estabilidad.
- Ruedas para facilitar el desplazamiento.
- Reposo planchas apto para centros de planchado. Medidas 44 x 27 cm.

### RECAMBIO FUNDA Y MULETÓN

Con una elevada resistencia a altas temperaturas y gracias a su superficie acolchada con muletón, la funda JATA HOGAR facilita el planchado, reduciendo cerca del 20% tanto el tiempo como el esfuerzo empleado.



Válido para	Modelo	U/C	EAN
Mod. TP550	RF55	6	8436017659313

Opciones de compra:  
[www.jata.es](http://www.jata.es) - [www.jata.pt](http://www.jata.pt)



## TABLA DE PLANCHAR LOGO XL "OPTIMA" PRO 136X46

MOD. TP600

- Superficie de planchado 136 x 46 cm.
- Estructura de aluminio con tratamiento anticorrosión (cataforesis).
- Plegable para fácil almacenamiento.
- Plataforma ergonómica en metal desplegado.
- Altura ajustable multiposiciones hasta 93 cm.
- Gran resistencia, hasta 40 kilos.
- Diseño de patas en "Y", alta estabilidad.
- Ruedas para facilitar el desplazamiento.
- Soporte para centros de planchado 38 x 34 cm.
- Reposo planchas extraíble.
- Medidas plegada 114 x 46 x 13 cm.

U/C 1 EAN 8436017659276



## TÁBUA DE ENGOMAR "SUPREMA" MOD. TP550

- Superficie para engomar 130 x 47 cm
- Estructura termolacada. Alta resistência à oxidação.
- Tábua de engomar ergonómica de metal expandido.
- Altura regulável multiposições até 95 cm.
- Modelo de pernas em "Y", de elevada estabilidade.
- Rodas para facilitar a deslocação.
- Suporte ajustável para garantir uma estabilidade ótima.
- Local para repouso adequado para ferros com caldeira. Medidas 44 x 27 cm

## TÁBUA DE ENGOMAR "XL OPTIMA PRO" MOD. TP600

- Superficie para engomar 136 x 46 cm
- Estructura de alumínio com tratamento anti-corrosão (cataforese).
- Dobrável para guardar facilmente.
- Tábua de engomar ergonómica de metal expandido.
- Altura regulável multiposições até 93 cm.
- Grande resistência, até 40 quilos.
- Modelo de pernas em "Y", de elevada estabilidade.
- Rodas para facilitar a deslocação.
- Suporte para ferros de engomar com caldeira 38 x 34 cm.
- Local para repouso do ferro de engomar extraível
- Medidas dobrada 114 x 46 x 13 cm.

## FITNESS ANALYSER MOD. 533



- Capacity 180 kg - Graduation 100 g.
- Analyses: body muscle, body water, body fat, body bone.
- Informs: suggested daily calories, body weight.
- 10 data memories.
- 6 mm tempered safety glass base.
- Large "LCD" display. 4 digits.
- Automatic switch off.
- Kg / lb / st conversion function.
- Low battery indicator.
- Overweight indicator.
- Works with 2 "AAA" batteries of 1,5 V (not included).

## FITNESS ANALYSER MOD. 531



- Capacity 180 kg - Graduation 100 g.
- Analyses: body muscle, body water, body fat, body bone.
- Informs: suggested daily calories, body weight.
- 5 mm "temperit" safety glass base.
- Large "LCD" display. 4 digits.
- 4 sensors. High precision.
- 12 data memories.
- Automatic switch on / off.
- Kg / lb / st conversion function.
- Low battery indicator.
- Overweight indicator.
- Works with 2 "AAA" batteries of 1,5 V (not included).

## FITNESS ANALYSER MOD. 565BL



- Capacity 150 kg - Graduation 100 g.
- 10 data memories.
- Analyses: body muscle, body water, body fat, body bone.
- Informs: Suggested daily calories - Body weight.
- Extra large 4 digit LCD display for easy viewing.
- 4 sensors. High precision.
- 6 mm "temperit" safety glass base.
- On / off switch.
- Kg / lb / st conversion function.
- Low battery indicator.
- Overweight indicator.
- Automatic switch off.
- Works with 4 "AAA" batteries of 1,5 V (not included).

## BLUETOOTH FITNESS ANALYSER MOD. 595



- Bluetooth technology compatible with all the iOS dispositives (iPhone, iPad, etc). "smart scale" application.
- Hi-tech ITO glass surface with integrated sensors inside.
- ITO technology: glass with invisible electrodes. Maximum efficiency.
- Analyses: Body muscle Body water - Body fat Visceral fat - Body bone Body mass index.
- Informs: Suggested daily calories - Body weight.
- 8 data memories.
- Capacity 150 kg - Graduation 100 g.
- Large "LCD" display. 4 digits.
- 6 mm. tempered safety glass base.
- Automatic switch off.
- Kg / lb.st. conversion function.
- Works with 4 "AAA" batteries of 1,5 V (not included).

## BLUETOOTH FITNESS ANALYSER MOD. 592



- Bluetooth technology compatible with iOS\* and Android devices. "FitBrick" application.
- Analyses: Body muscle Body water - Body fat Body bone - Body mass index.
- Informs: Basal metabolic rate - Body weight.
- Capacity 180 kg - Graduation 100 g.
- Unlimited memories.
- Target weight setting function.
- Baby mode function.
- Back light "LCD" display. 4 digits.
- 6 mm. tempered safety glass base.
- Automatic switch off.
- Kg / lb. conversion function.
- Works with 3 "AAA" batteries of 1,5 V. (not included).

## FITNESS ANALYSER MOD. 577



- Capacity 180 kg - Graduation 100 g.
- Analyses: body muscle, body water, body fat, body bone, body mass index.
- Informs: suggested daily calories, body weight.
- 10 data memories.
- 12 mm bamboo surface.
- Touch sensor knobs.
- Back light "LCD" display.
- Automatic switch off.
- Kg / lb / st conversion function.
- Low battery indicator.
- Overweight indicator.
- Works with 2 "AAA" batteries of 1,5 V (not included).

## WATER BODY FAT ANALYSER MOD. 534



- Capacity 150 kg - Graduation 100 g.
- 10 data memories.
- Sets the analysis result of water and fat separately.
- 5 mm "temperit" safety glass base.
- Touch sensor knobs.
- "LCD" display with large digits.
- Automatic switch off.
- Kg / lb / conversion function.
- Low battery indicator.
- Overweight indicator.
- Works with 1 CR2032 long life lithium battery (included).

## FITNESS ANALYSER MOD. 564



- Capacity 180 kg - Graduation 100 g.
- 10 data memories.
- Extra large LCD display
- Analyses: body muscle, body water, body fat, body bone, body mass index.
- Informs: suggested daily calories, body weight.
- 4 sensors. High precision.
- Automatic switch on / off.
- Kg / lb / st conversion function.
- Low battery indicator.
- Overweight indicator.
- 6 mm "temperit" safety glass base.
- Works with 3 "AAA" batteries of 1,5 V (not included).

## NEW "U-POWER" BAGGAGE SCALE MOD. 55K



- Ecological. Battery free technology.
- "U-Power": automatic energy generation.
- Capacity 50 kg - Graduation 50 g.
- "LCD" display.
- Net weight function.
- Kg/lb conversion switch.
- Automatic switch off.
- Overweight indicator.

## "U-POWER" ELECTRONIC BATHROOM SCALE MOD. 499



- Ecological. Battery free technology.
- "U-Power": automatic energy generation.
- Capacity 150 kg - Graduation 100 g.
- 4 sensors. High precision.
- Large "LCD" display. 4 digits.
- Automatic switch off.
- Kg/lb conversion switch.
- Overweight indicator.
- 5 mm tempered safety glass base.

## ELECTRONIC BABY SCALE MOD. 590



- Capacity 20 kg - Graduation 5 g.
- Big size surface.
- Immediate weight result.
- Hold function: registers the weight even with movement.
- Large "LCD" display. 5 digits.
- Tare weight function.
- 4 sensors. High precision.
- Automatic switch off.
- Overweight indicator.
- Low battery indicator.
- Kg / lb. / st. conversion switch.
- Works with 1 CR2032 long life lithium battery (included).

## ELECTRONIC GLASS BATHROOM SCALE "METEO" MOD. 530



- Capacity 180 kg - Graduation 100 g.
- Informs: weather forecast, indoor temperature, outdoor temperature, weight, hour and alarm.
- 6 mm tempered safety glass base.
- 4 sensors. High precision.
- Back light "LCD" display. 4 digits.
- Automatic switch on / off.
- Overweight indicator.
- Low battery indicator.
- Kg / lb / st conversion switch.
- Scale works with 4 "AA" batteries of 1,5 V (not included).
- Transmitter works with 2 "AAA" batteries of 1,5 V (not included).

## ELECTRONIC SOLAR BATHROOM SCALE MOD. 580



- Capacity 180 kg - Graduation 100 g.
- Ecologic. Without batteries.
- Works with sun energy and artificial light.
- 4 sensors. High precision.
- Automatic switch on / off.
- Overweight indicator.
- Minimum lighting necessary, only 20 lux. Large "LCD" display. 4 digits.
- Kg / lb / st conversion switch.

## ELECTRONIC SOLAR BATHROOM SCALE MOD. 578



- Capacity 150 kg - Graduation 100 g.
- Ecologic. Without batteries.
- Works with sun energy and artificial light.
- Minimum lighting necessary, only 40 lux.
- 4 sensors. High precision.
- Large "LCD" display. 4 digits.
- Automatic switch on / off.
- Overweight indicator.
- Kg / lb / st conversion switch.

## NEW ELECTRONIC BATHROOM SCALE MOD. 496N



- Capacity 150 kg - Graduation 50 g.
- Stainless steel surface.
- Informs: weight and environment temperature.
- Backlight "LCD" display.
- 4 sensors. High precision.
- Automatic switch on / switch off.
- Overweight indicator.
- Low battery indicator.
- Kg / lb conversion switch.
- Works with 2 CR2032 long life lithium batteries (included).

## NEW ELECTRONIC BATHROOM SCALE MOD. 498



- Capacity 150 kg - Graduation 50 g.
- "HPL" surface: High resistance laminate. Ideal for wet places.
- Informs: weight and environment temperature.
- Backlight "LCD" display.
- 4 sensors. High precision.
- Automatic switch on / off.
- Overweight indicator.
- Low battery indicator.
- Kg / lb. conversion switch.
- Works with 2 CR2032 long life lithium batteries (included).

## NEW ELECTRONIC BATHROOM SCALE MOD. 430



- Capacity 180 kg - Graduation 100 g.
- Extra strong structure up to 180 kg capacity.
- Extra-flat design.
- Large "LCD" display. 4 digits.
- 4 sensors. High precision.
- Automatic switch on / off.
- Overweight indicator.
- Low battery indicator.
- Kg/lb/st conversion switch.
- Works with 1 CR2032 long life lithium battery (included).



## ELECTRONIC GLASS BATHROOM SCALE

MOD. 493N



- Capacity 180 kg - Graduation 100 g.
- 6 mm tempered safety glass base.
- Large "LED" display. 4 digits.
- 4 sensors. High precision.
- Automatic switch on / off.
- Overweight indicator.
- Low battery indicator.
- Kg / lb / st conversion switch.
- Works with 4 "AAA" batteries of 1,5 V (not included).
- Available in 3 colors.



## ELECTRONIC GLASS BATHROOM SCALE

MOD. 503



- Capacity 150 kg - Graduation 100 g.
- 6 mm "temperit" safety glass base.
- 4 sensors. High precision.
- Large "LCD" display. 4 digits.
- Automatic switch on / off.
- Overweight indicator.
- Low battery indicator.
- Kg / lb / st conversion switch.
- Works with 1 CR2032 "lithium" battery (included).

## ELECTRONIC GLASS BATHROOM SCALE

MOD. 495



- Capacity 180 kg - Graduation 100 g.
- 6 mm tempered safety glass base.
- Large "LCD" display. 4 digits.
- 4 sensors. High precision.
- Automatic switch on / off.
- Overweight indicator.
- Low battery indicator.
- Kg / lb / st. conversion switch.
- Works with 2 "AAA" batteries of 1,5 V (not included).

## ELECTRONIC GLASS BATHROOM SCALE

MOD. 290V 290R 290P



- Capacity 150 kg - Graduation 100 g.
- 6 mm tempered safety glass base.
- Large "LCD" display. 4 digits.
- 4 sensors. High precision.
- Automatic switch on / switch off.
- Overweight indicator.
- Low battery indicator.
- Kg / lb / st conversion switch.
- Works with 1 CR2032 long life lithium battery (included).
- Available in 3 colors.



## ELECTRONIC GLASS BATHROOM SCALE

MOD. 400



- Capacity 150 kg - Graduation 100 g.
- Big size surface.
- Extra-flat design.
- Large "LCD" display. 4 digits.
- 4 sensors. High precision.
- Automatic switch on / off.
- Overweight indicator.
- Low battery indicator.
- Kg / lb / st conversion switch.
- Works with 2 "AAA" batteries of 1,5 V (not included).
- Available in 4 colors.



## ELECTRONIC GLASS BATHROOM SCALE

MOD. 450

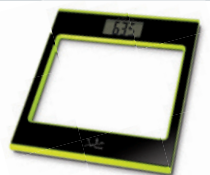

- Capacity 180 kg - Graduation 100 g.
- 6 mm tempered safety glass base.
- Large "LCD" display. 4 digits.
- 4 sensors. High precision.
- Automatic switch on / off.
- Overweight indicator.
- Low battery indicator.
- Kg / lb / st conversion switch.
- Works with 1 CR2032 long life lithium battery (included).

## BAMBOO ELECTRONIC BATHROOM SCALE

MOD. 494

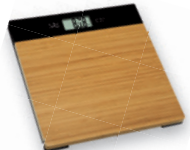

- Capacity 180 kg - Graduation 100 g.
- 16 mm solid bamboo surface.
- Large "LCD" display. 4 digits.
- 4 sensors. High precision.
- Automatic switch on / off.
- Overweight indicator.
- Low battery indicator.
- Kg / lb / st conversion switch.
- Works with 2 "AAA" batteries of 1,5 V (not included).

## MECHANICAL BATHROOM SCALE

MOD. 67



- Capacity 130 kg - Graduation 1 kg.
- Big size surface.
- Epoxy body.
- Easy cleaning.
- Easy reading large dial.
- Manual adjustment.

## MECHANICAL BATHROOM SCALE

MOD. 63



- Capacity 130 kg - Graduation 1 kg.
- Big size surface.
- Epoxy body.
- Easy cleaning.
- Easy reading large dial.
- Manual adjustment.

## ELECTRONIC KITCHEN SCALE

MOD. 699



- Capacity 10 kg - Graduation 1 g.
- Stainless steel surface.
- High electronic accuracy.
- Large "LCD" display.
- Net weight function.
- G/lb/oz/oz conversion function.
- Optional wall-mount.
- Automatic switch off.
- Low battery / Overload indicator.
- Works with 2 "AAA" batteries of 1,5 V (not included).

## ELECTRONIC KITCHEN SCALE

MOD. 715



- Capacity 15 kg - Graduation 1 kg.
- Big tempered glass surface: 30 x 22,5 cm.
- High electronic accuracy.
- Large "LCD" display.
- Lock weighing function for large volumes.
- Net weight function.
- Kg / lb conversion function.
- Optional wall-mount.
- Automatic switch off.
- Low battery indicator.
- Overload indicator.
- Works with 2 "AAA" batteries of 1,5 V (not included).

## NEW ELECTRONIC KITCHEN SCALE

MOD. 719



- Capacity 15 kg - Graduation 1 g.
- Stainless steel surface.
- High electronic accuracy.
- Back light "LCD" display.
- Clock.
- Net weight function.
- Timer function.
- Conversion function: g / kg / oz / lb / fl.oz.
- Low battery indicator.
- Overload indicator.
- Works with 2 "AAA" batteries of 1,5 V (not included).

## NEW ELECTRONIC KITCHEN SCALE

MOD. 780



- Capacity 20 kg - Graduation 1g / 1ml.
- Mixed surface: temperit glass and stainless steel.
- Lock weighing function for large volumes.
- High electronic accuracy.
- Large "LCD" display.
- Touch sensor knobs.
- Net weight function.
- Automatic switch off.
- Kg/g/ml/lb/oz/fl.oz conversion function.
- Low battery indicator.
- Overload indicator.
- Optional wall-mount.
- Works with 1 CR2032 long life lithium battery (included).

## NEW ELECTRONIC KITCHEN SCALE

MOD. 720



- Capacity 15 kg - Graduation 1 g.
- 5 mm bamboo thickness.
- High electronic accuracy.
- Back light "LCD" display.
- Clock.
- Net weight function.
- Timer function.
- Conversion function: g / kg / oz / lb / fl.oz.
- Low battery indicator.
- Overload indicator.
- Works with 2 "AAA" batteries of 1,5 V (not included).

## HIGH PRECISION SCALE

MOD. 773



- Capacity 3 kg - Graduation 0,1 g.
- Stainless steel surface.
- High weighing accuracy.
- Backlight LCD display.
- On pusher.
- Calibration function.
- Lock weighing function.
- Automatic switch off.
- Net weight function.
- G / oz / ozt / ct / dwt conversion function.
- 2 protective covers with tray function.
- Works with 2 "AAA" batteries of 1,5 V (not included).

## ELECTRONIC KITCHEN SCALE DOUBLE PLATFORM

MOD. 770



- Independent weighting platforms.
- Tempered safety glass surface:
  - Capacity 5 kg - Graduation 1 g.
  - Measures: 23 x 16 cm.
- Removable stainless steel base for small weighing:
  - Capacity 350 g - Graduation 0,1 g.
  - Measures: 7 x 6 cm.
- Net weight function.
- High electronic accuracy with 5 sensors. Touch sensor knob.
- Backlight "LCD" display. 4 digits.
- Kg / oz / gn / ct conversion function.
- Automatic switch off.
- Low battery indicator.
- Overload indicator.
- Works with 2 "AAA" batteries of 1,5 V. (not included).

## MULTI FUNCTION ELECTRONIC KITCHEN SCALE

MOD. 756



- Capacity 3 kg - Graduation 1 g / 1 ml.
- High electronic accuracy.
- Bigger "LCD" display shows: date, hour, alarm, temperature, humidity.
- Back light "LCD" display shows: weight.
- Wall-mounted.
- Tempered safety glass base.
- Touch sensor knobs for switch on and tare.
- Low battery indicator.
- Overload indicator.
- Kg / lb / ml / fl.oz conversion function.
- Works with 3 "AAA" batteries of 1,5 V (not included).



## SUPER SLIM KITCHEN SCALE

MOD. 764



- Capacity 5 kg - Graduation 1 g / 1 ml.
- Stainless steel surface.
- Super slim design.
- High electronic accuracy.
- "LCD" display, 4 digits.
- Net weight function.
- On / off switch.
- Kg / lb / ml conversion function.
- Automatic switch off.
- Low battery indicator.
- Overload indicator.
- Works with 2 CR2032 long life lithium batteries (included).

## ELECTRONIC DIET KITCHEN SCALE

MOD. 762



- Capacity 5 kg - Graduation 1 g - 1 ml.
- Analyzes calories and carbohydrates of 14 foods.
- Tempered safety glass base.
- High electronic accuracy.
- Touch sensor knobs.
- Back light "LCD" display.
- Automatic switch off.
- Overweight indicator.
- Low battery indicator.
- Net weight function.
- G / oz / ml conversion function.
- Works with 2 CR2032 long life "lithium" batteries (included).

## NEW ELECTRONIC NUTRITIONAL DIET KITCHEN SCALE

MOD. 790



- Capacity 5 kg - Graduation 1 g - 1 ml.
- Weighs and analyses 7 nutritional values: calories, protein, carbohydrates, sodium, fat, cholesterol, fibre.
- Nutritional information over 999 foods or ingredients.
- Memory: 99 entry.
- Full results on the screen.
- Tempered safety glass surface.
- Large "LCD" display.
- High electronic accuracy.
- Automatic switch off.
- Overweight indicator.
- Low battery indicator.
- Net weight function.
- G / oz / ml / fl.oz / lb.oz. conversion function.
- Works with 3 "AAA" batteries of 1,5 V (not included).

## ELECTRONIC KITCHEN SCALE WITH JUG

MOD. 766



- Capacity 2 kg - Graduation 1 g - 1 ml.
- Informs: Weight - Water volume - Milk volume.
- Removable jug BPA free. Capacity 1.200 ml.
- Removable jug pusher.
- High electronic accuracy.
- Net weight function.
- Back light "LCD" display, 4 digits.
- Automatic switch off.
- G / lb / ml conversion function.
- Low battery indicator.
- Overload indicator.
- Works with 2 "AAA" batteries of 1,5 V (not included).

## MULTI FUNCTION ELECTRONIC KITCHEN SCALE

MOD. 765



- Capacity 5 kg - Graduation 1 g / 1 ml.
- Informs: weight, water volume, milk volume.
- Removable stainless steel bowl. Capacity 1,8 L.
- High electronic accuracy.
- Touch sensor knobs.
- Net weight function.
- "LCD" display, 4 digits.
- Conversion function: g - lb.oz / ml - fl.Oz.
- Automatic switch off.
- Low battery indicator.
- Overload indicator.
- Works with 2 "AAA" batteries of 1,5 V (not included).

## ELECTRONIC KITCHEN SCALE

MOD. 709N



- Capacity 5 kg - Graduation 1 g.
- High electronic accuracy.
- Touch sensor knobs.
- Back light "LCD" display.
- Great capacity transparent bowl 2 L. Suitable for alimentary use.
- Net weight function.
- Automatic switch off.
- Low battery indicator.
- Overload indicator.
- Kg / oz conversion function.
- Works with 2 "AAA" batteries of 1,5 V (not included).

## ELECTRONIC KITCHEN SCALE "LA MINI"

MOD. 717



- Capacity 1 kg - Graduation 1 g / 1 ml.
- High electronic accuracy.
- Bowl with handle suitable for solids and liquids. Capacity 300 ml.
- "LCD" display, 4 digits.
- Net weight function.
- On/off switch.
- Low battery indicator.
- Overload indicator.
- Conversion function g / oz / ml.
- Automatic switch off.
- Works with 2 "AAA" batteries of 1,5 V (not included).

## ELECTRONIC KITCHEN SCALE

MOD. 727N



- Capacity 5 kg - Graduation 1 g / 1 ml.
- High electronic accuracy.
- Touch sensor knob.
- Net weight function.
- Tempered safety glass surface.
- "LCD" display, 4 digits.
- Kg / lb conversion function.
- Automatic switch off.
- Low battery indicator.
- Overload indicator.
- Works with 1 CR2032 long life lithium batterie (included).
- Available in 4 colors.

## ELECTRONIC KITCHEN SCALE

MOD. 723



- Capacity 5 kg - Graduation 1 g.
- High electronic accuracy.
- Touch sensor knob.
- Net weight function.
- Tempered safety glass surface.
- "LCD" display, 4 digits.
- Kg / lb conversion function.
- Automatic switch off.
- Low battery indicator.
- Overload indicator.
- Works with 1 CR2032 long life lithium battery (included).
- Available in 4 colors.

## ELECTRONIC KITCHEN SCALE

MOD. 722 / 722P



- Capacity 5 kg - Graduation 1 g - 1 ml.
- Informs: Weight - Water volume - Milk volume.
- High electronic accuracy.
- Touch sensor knob.
- Net weight function.
- Tempered safety glass surface.
- "LCD" display, 4 digits.
- Kg / lb conversion function.
- Automatic switch off.
- Low battery indicator.
- Overload indicator.
- Works with 2 CR2032 long life lithium batteries (included).

## ELECTRONIC KITCHEN SCALE

MOD. 729V 729R



- Capacity 5 kg - Graduation 1 g - 1 ml.
- Informs: Weight - Water volume - Milk volume.
- High electronic accuracy.
- Touch sensor knobs.
- Net weight function.
- Tempered safety glass surface.
- "LCD" back light display, 4 digits.
- G / lb / ml conversion function.
- Automatic switch off.
- Low battery indicator.
- Overload indicator.
- Works with 2 "AAA" batteries of 1,5 V (not included).

## ELECTRONIC KITCHEN SCALE

MOD. 612VE 612NA



- Capacity 5 kg - Graduation 25 g.
- Stainless steel bowl. Great capacity.
- Easy reading dial.
- Net weight and manual adjustment.
- Suitable for alimentary use.
- Metallic housing.
- Available in 2 colors.

## MECHANICAL KITCHEN SCALE

MOD. 603



- Capacity 3 kg - Graduation 25 g.
- Innovative design.
- Transparent graded bowl suitable for solids and liquids. Capacity 1 L.
- Manual adjustment.
- Specially recommended for dietetic use.
- Minimum storage space.
- Suitable for alimentary use.

## MECHANICAL KITCHEN SCALE

MOD. 610N



- Capacity 3 kg - Graduation 25 g.
- Ultra flat design and horizontal display.
- Easy reading dial.
- Net weight function.
- Minimum storage space.
- Specially recommended for dietetic use.
- Bowl with handle suitable for solids and liquids. Capacity 1 L.
- Suitable for alimentary use.

## LIGHT CAST FRY PAN "TIMANFAYA"

MOD. SAC1



- ILAG non-stick coating free of PFOA.
- 2 mm light cast iron body.
- Silicone exterior coating:
  - Anti-rust.
  - Perfect heat performance.
- Heatless stainless steel handle with silicone.
- Suitable for all cookers, induction included.
- Available in different diameters: 20 - 24 - 26 - 28 cm.

## ENAMELLED FRY PAN "TAMBORA"

MOD. SEA



- 1,5 mm vitrified enamelled steel fry pan.
- "Stonite" Whitford's Xylan® Plus non-stick coating free of PFOA.
- Suitable for all cookers, induction included.
- Perfect heat performance.
- Fire resistant handle.
- Available in different diameters. 18 - 20 - 22 - 24 - 26 - 28 - 30 cm.

## FULL INDUCTION FRY PAN "MAUNA"

MOD. S1 - SET S1



- Full induction bottom.
- Whitford Xylan® Plus non-stick coating free of PFOA.
- 2.5 mm aluminium press body.
- Perfect heat performance.
- Fire resistant handle.

- Suitable for all cookers, induction included.
- Available in different diameters: 18 - 20 - 22 24 - 26 - 28 - 30 cm.

Mod. Set S1 :  
3 piece fry pan set:  
Ø 18 - 22 - 26 cm

## FULL INDUCTION FRY PAN "TEIDE"

MOD. S



- Full induction bottom.
- Pfluo "Stonite" non-stick coating free of PFOA.
- 3 mm aluminium press body.
- Perfect heat performance.

- Fire resistant handle.
- Suitable for all cookers, induction included.
- Available in different diameters: 18 - 20 - 22 24 - 26 - 28 - 30 cm.

## NEW FULL INDUCTION PAELLERA "JORDAN"

MOD. P34 - P38



- Full induction bottom.
- Pfluo non-stick coating free of PFOA.
- Perfect heat performance.

- 3 mm. aluminium pressed body.
- Suitable for all cookers, induction included.
- Available in 2 diameters: 34 - 38 cm.

## FRY PAN "EGG FRIED"

MOD. SM14N



- Pfluo non-stick coating free of PFOA.
- Ø 14 cm.
- Aluminium body.
- Silicone handle.

- Easy cleaning.
- Suitable for gas, electric, vitro and halogen cookers.
- Available in different colors.
- Silicone spatula included.

## ECOLOGICAL MINI PAN

MOD. CME



- Ecological non-stick ceramic coating free of PFOA and PTFE.
- Aluminium body.
- Silicone handle.
- Diameter 12 cm.

- Capacity 500 ml.
- Easy cleaning.
- Suitable for gas, electric, vitro and halogen cookers.
- Available in 3 colors.

## FULL INDUCTION WOK-FRY PAN "MARSILI"

MOD. SEW



- Full induction bottom.
- Pfluo "Stonite" non-stick coating free of PFOA.
- Silicone coating exterior:
  - Anti-rust.
  - Perfect heat performance.

- Aluminium forged body.
- Fire resistant handle.
- Suitable for all cookers, induction included.
- Available in different diameters: 20 - 24 - 28 cm.

## FULL INDUCTION FRY PAN "FUJI"

MOD. SF1 - SET SF1



- Full induction bottom.
- "Stonite" Whitford's Xylan® Plus non-stick coating free of PFOA.
- Perfect heat performance.
- 3 mm aluminium forged body.
- Fire resistant handle.

- Suitable for all cookers, induction included.
- Available in different diameters: 18 - 20 - 22 24 - 26 - 28 - 30 cm.

Mod. Set SF1 :  
2 piece fry pan set:  
Ø 20 - 24 cm.

## FULL INDUCTION FRY PAN "TACANÁ"

MOD. SF3



- Full induction bottom.
- Pfluo "Granite" non-stick coating free of PFOA.
- Perfect heat performance.
- Silicone exterior coating:
  - Resistant to high temperatures.
  - Perfect heat performance.

- Fire resistant handle.
- Suitable for all cookers, induction included.
- Aluminium forged body.
- Available in different diameters: 18 - 20 - 22 - 24 - 26 - 28 - 30 cm.

## NEW FORGED ALUMINUM FRY PAN DYFLON "GOLAN"

MOD. SF4 - MOD. SET SF4 182226  
MOD. SET SF4 2024



- Full induction bottom.
- Dyflon non-stick coating free of PFOA.
- 3 mm. aluminium forged body.
- Perfect heat performance.
- Stainless steel handle, riveted hollow.
- Suitable for all cookers, induction included.

- Pan protector included.
- Available in different diameters: 18 - 20 - 22 - 24 - 26 - 28 - 30 cm

Mod. Set SF4 2024:  
2 piece fry pan set:  
Ø 20 - 24 cm.

Mod. Set SF4 182226:  
3 piece fry pan set:  
Ø 18 - 22 - 26 cm

## FULL INDUCTION GRILL TRAY "KILIMANJARO"

MOD. GMA - GP35



- Full induction bottom.
- Pfluo "Stonite" non-stick coating free of PFOA.
- Die-casting aluminium body.
- Perfect heat performance.

- Wavy surface for a fat free roast.
- Wooden foldable handle.
- Two pouring spouts.
- Suitable for all cookers, induction included.

Grill measures	Model	Ø Induction base
24 x 24 cm	GMA24	17,1 cm
28 x 28 cm	GMA28	20,2 cm
25 x 35 cm	GP35	17,6 cm

## ENAMELLED GRILL "TAMBORA"

MOD. GEA28



- 1,5 mm vitrified enamelled steel grill.
- "Stonite" Whitford's Xylan® Plus non-stick coating free of PFOA.
- Measures 28 x 28 cm.

- Perfect heat performance.
- Fire resistant handle.
- Suitable for all cookers, induction included.

## NEW GRILL "FOGO"

MOD. GR25 - GR33



- Especially for meats and vegetables.
- Enamelled cast iron:
  - Perfect distribution of heat.
  - Fast temperature transmission.
  - Maintenance of maximum heat.
  - Resistant and durable.
  - Enamelled inside and outside.
- Healthy and natural cuisine.
- Lateral handles.

- Suitable for:
  - Oven and barbecue.
  - All types of kitchens: induction, gas, vitroceramic, electric cooker.
- Easy to clean.

Grill measures	Model
Ø 25 cm	GR25
33 x 21,5 cm	GR33

## NEW TRAY GRILL ROASTER "BELY"

MOD. GB36 - GB37



- Full induction bottom.
- Perfect heat performance.
- Whitford's Xylan® Plus non-stick coating free of PFOA.
- 3 mm. aluminium forged body.

- Wavy surface for a fat free roast.
- Removable silicone handles.
- Suitable for all cookers, induction included.

Grill measures	Model	Cooking surface
36 x 23 x 5 cm	GB36	28 x 22 cm
38 x 27 x 5 cm	GB37	28 x 24 cm

## NEW GRILL FULL INDUCTION "BELY"

MOD. G24 - G28



- Full induction bottom.
- Perfect heat performance.
- Whitford's Xylan® Plus non-stick coating free of PFOA.
- 4 mm. aluminium forged body.
- Wavy surface for a fat free roast.

- Suitable for all cookers, induction included.

Grill measures	Model
24 x 24 cm	G24
28 x 28 cm	G28

## NEW FULL INDUCTION COOKWARE

MOD. BC3



Diameter	Capacity	Height
Saucepan 16 cm	1,1 L	7 cm
Casserole 20 cm	2,4 L	9,5 cm
Casserole 24 cm	4,2 L	12 cm

- 3 pieces with lid:

- "Stonite" Whitford's Xylan® Plus non-stick coating free of PFOA.
- Forged aluminium body.
- 3 mm sandwich base for maintenance, control and perfect heat diffusion.
- Suitable for all cookers, induction included.

## FULL INDUCTION COOKWARE

MOD. BC4



Diameter	Capacity	Height
Saucepan 16 cm	1,2 L	7,5 cm
Casserole 20 cm	2 L	8 cm
Casserole 24 cm	3,8 L	10 cm
Fry Pan 24 cm	-	4,5 cm

- 4 pieces + 2 lids:

- Granite Pfluo nonstick coating free of PFOA.
- Forged aluminium body.
- 3,5 cm sandwich base for maintenance, control and perfect heat diffusion.
- Suitable for all cookers, induction included.



## COOKWARE SET



MOD. BC8

## MOD. BC8 - BC10

### MOD. BC8

4 pieces with lids:

Diameter	Capacity	Height
Saucepan 16 cm	1,8 L	9 cm
Casserole 18 cm	2,5 L	10 cm
Casserole 22 cm	4,5 L	12 cm
Casserole 24 cm	3 L	6,5 cm

### MOD. BC10

5 pieces with lids:

Diameter	Capacity	Height
Saucepan 16 cm	1,8 L	9 cm
Casserole 18 cm	2,5 L	10 cm
Casserole 20 cm	3,2 L	11 cm
Casserole 24 cm	6 L	13 cm
Casserole 26 cm	3,5 L	6,5 cm



MOD. BC10

- Sandwich base to keep, control and perfect heat diffusion.
- Tempered glass lid.
- Stainless steel handles and knobs with silicone protection.
- Suitable for all cookers, induction included.

## CLASSIC PRESSURE COOKER 4 - 6 - 8 - 10 L

## MOD. OPC



- Curved body.
- 3 security systems.
- Progressive closing system by rotary handle.
- SUS304 stainless steel.
- 1 mm thickness body.
- 5 mm sandwich base.
- Lateral handles.
- Suitable for all cookers, induction included.

## "SECURITY" PRESSURE COOKER 4 - 6 L

## MOD. OP



- High security.
- Pressure 80 Kpa.
- SUS304 stainless steel.
- Adjustable pressure.
- Diameter 22 cm.
- 1,2 mm thickness body.
- 5 mm sandwich base.
- Suitable for all cookers, induction included.

## SET PRESSURE COOKER

## MOD. OPS46



- SUS304 stainless steel.
- Includes:
  - Pressure cookers bodies of 4 and 6 litres.
  - Glass lid.
  - Pressure Lid.
  - Stainless steel steam rack.
- High security.
- Pressure 80 Kpa.
- Diameter 22 cm.
- 1,2 mm thickness body.
- 5 mm sandwich base.
- Suitable for all cookers, induction included.

## FAST PRESSURE COOKER 4 - 6 - 8 L

## MOD. OSR



- 4 security devices.
- Sealed pressure valve. No smell.
- Silent, safe and attractive design.
- Top security.
- Cooks one third faster than traditional pressure cookers.
- SUS304 stainless steel.
- Diameter 22 cm.
- 1,2 mm. thickness body.
- 5 mm. sandwich base.
- Advantages of steam cooking pressure:
  - Fast: up to 70% reduction in cooking time.
  - Healthy: retains vitamins and minerals.
  - Energy savings.
- Silicone ring.
- Suitable for all cookers, induction included.

## NEW FULL INDUCTION ITALIAN COFFEE MAKER

## MOD. CFI



- Full induction bottom.
- Anti-rust inner coating treatment.
- Inner polished.
- Solid handle.
- Aluminium body.
- Silicone ring.
- Suitable for all cookers, induction included.

Model	Cups
CFI6	6
CFI9	9
CFI12	12

## NEW ITALIAN COFFEE MAKER

## MOD. CCA



- Anti-rust inner coating treatment.
- Inner polished.
- Solid handle.
- Silicone ring.
- Aluminium body.

Model	Cups
CCA3	3
CCA6	6
CCA9	9
CCA12	12

## INDUCTION ITALIAN INOX COFFEE MAKER "ODIN"

## MOD. CAX1



- Manufactured in stainless steel.
- Boiler and upper body with "Sand Blaster" inner treatment.
- Shine finishing.
- Solid handle.
- Suitable for all cookers, induction included.

Model	Cups
CAX104	4
CAX106	6
CAX110	10
CAX112	12

## INDUCTION ITALIAN INOX COFFEE MAKER

## MOD. CAX



- Manufactured in stainless steel.
- Boiler and upper body with "Sand Blaster" inner treatment.
- Shine finishing.
- Solid handle.
- Suitable for all cookers, induction included.

Model	Cups
CAX4	4
CAX6	6
CAX9	9

## CARTRIDGES

## MOD. REC07X3 - RE123X4



MOD. REC07X3



MOD. RE123X4

## WATER FILTER JARS

## MOD. JH01 - JH03



- MOD. JH01: Capacity 2,5 L.
- MOD. JH03: Capacity 3,5 L.
- Exclusive JATA HOGAR filter.
- Ionic filter.
- Improves the quality and taste of water remaining the essentials minerals.
- 150-180 L. filtered water or 30-45 days.

- Reduces: chlorine by up to 80%, limescale by up to 95%, cooper by up to 50%.
- Adjust the pH value to 7-8.
- Manual indicator to control the filter.
- Suitable for placing in the door of the fridge.
- Anti-sliding base.
- Ergonomic handle.

## KITCHEN TOOL SET

## MOD. AC7



- Nylon kitchen utensils 7 + 1:
  - Spatula.
  - Pasta server.
  - Soup ladle.
  - Skimmer spoon.
  - Serving spoon.
  - 1 turner.
  - 1 slotted turner.
  - Tongs.
- Ergonomic handle.
- Hygienic and healthy, complied with FDA and LFGB standards.
- Heat resistance over 200 °C.

## NEW KITCHEN TOOL SET

## MOD. AC6



- Pasta server.
- Soup ladle.
- Skimmer spoon.
- Serving spoon.
- Turner.
- Slotted turner.
- Ergonomic handle of anti-slip TPR silicon.
- Hygienic and healthy, complied with FDA standards.
- Heat resistance over 200 °C.
- Table stand included.

## LUNCH BOX

## MOD. 942 - 943



- Double isolating wall to preserve better cold or warm food.
- Hygienic and healthy, complied with FDA standard.
- High resistance against shock.
- Transport handle.
- BPA free.
- 21,4 cm diameter
- MOD. 942: Capacity 2 L.
- MOD. 943: Capacity 3 L.
- 1 L recipient included. Suitable for the microwave.

## NEW STAINLESS STEEL VACUUM FLASK

## MOD. 834



- Capacity 200 ml.
- Double wall stainless steel. High quality.
  - Inner side: stainless steel 304.
  - Outer side: stainless steel 201.
- BPA free.
- Thermal insulation. Preserve the drink cold or heat for hours.
- Threaded lid. Hermetic locking.
- Light and easy to transport.

## STAINLESS STEEL VACUUM FLASK

## MOD. 835 - 836 - 837 - 838



- Double wall stainless steel. High quality. Inner side: stainless steel 304.
- BPA free.
- Silicone base and non-slip grip zone.
- Hermetic locking.
- High resistance against drop shock.
- Light and easy to transport.
- Preserve the drink cold or heat for hours.
- Thread lid for using as a cup.
- Fast closing / opening pouring lip, just pressing with the finger.

## NEW PERSONAL TRAVEL THERMO

MOD. 840



- Capacity 350 ml.
- Double wall stainless steel. High quality.
  - Inner side: stainless steel 304.
  - Outer side: stainless steel 201.
- Thermal insulation. Preserve the drink cold or heat for hours.
- Screw lid.
- Hermetic locking with opening pusher.
- Folding handle for hanging.
- Light and easy to transport.
- BPA free.

## STAINLESS STEEL VACUUM FLASK

MOD. 825 - 827



- Double wall stainless steel. High quality. Inner side: stainless steel 304.
- Preserves food hot or cold for several hours.
- Inner lid with decompression valve for an easy opening.
- BPA free.
- Silicone base and non-slip grip zone.
- High resistance against drop shock.
- Light and easy to transport.
- Hermetic locking.
- Thread lid.
- Capacity 500 ml. / 750 ml.

## STAINLESS STEEL VACUUM FLASK

MOD. 917A 917G



- Capacity 1 L.
- Double wall stainless steel. High quality. Inner side: stainless steel 304.
- BPA free.
- High resistance against drop shock.
- Light and easy to transport.
- Hermetic locking.
- Preserve the drink cold or hot for hours.
- Thread lid for using as a cup.
- Fast closing / opening pouring lip, just pressing with the finger.
- Available in 2 colours: blue and deep red.

## STAINLESS STEEL VACUUM FLASK

MOD. 909 - 918 - 919 - 920



- Double wall stainless steel. High quality. Inner side: stainless steel 304.
- BPA free.
- Light and easy to transport.
- Hermetic locking.
- High resistance against drop shock.
- Preserve the drink cold or heat for hours.
- Thread lid for using as a cup.
- Fast closing / opening pouring lip, just pressing with the finger.

## MAGIC - SUCTION MUG

MOD. 950



- Suction pad, anti-fall special system.
- Suitable for smooth surfaces, not porous.
- Double wall, optimum insulation.
- Stainless steel inner side.
- BPA free.
- 400 ml. capacity
- Handle and lid.
- Utility model registered.

## FOLDABLE SILICONE LUNCH BOX

MOD. 903



- Foldable, minimum storage space.
- Capacity 540 ml.
- Keeps the food fresh.
- Hygienic and healthy, complied with LFGB standard.
- BPA free.
- Suitable for solids and liquids.
- Totally hermetic.
- Lid with locking valve.
- Microwave and freezer safe.
- Dishwasher safe.
- Easy cleaning.

## GLASS CONTAINERS

MOD. RC



MOD. RC50



MOD. RC51



MOD. RC52

- Tempered glass containers.
- Allows to preserve food healthy and hygienic.
- Suitable for oven, freezer, microwave and dishwasher.
- Hermetic, without mixing odours or flavours.
- Suitable for solid and liquid foods.
- Lid with valve for easy opening.
- BPA free.

Model	Containers	Measures	High	Capacity
RC50	3	Ø 12,3 cm	5,5 cm	390 ml
		Ø 14,3 cm	6,0 cm	600 ml
		Ø 16,3 cm	6,5 cm	880 ml
RC51	2	12 x 12 cm	5,5 cm	430 ml
		15,5 x 15,5 cm	6,5 cm	900 ml
RC52	2	14,3 x 9,5 cm	5,5 cm	400 ml
		18,3 x 12,5 cm	6,5 cm	830 ml

## FOLDABLE SILICONE LUNCH BOX

MOD. 905



- Double compartment. Total capacity 750 ml (450 ml + 300 ml).
- Foldable, minimum storage space.
- Keeps the food fresh.
- Hygienic and healthy, complied with LFGB standard.
- BPA free.
- Suitable for solid food.
- Microwave and freezer safe.
- Dishwasher safe.
- Easy cleaning.
- Spoon-fork included.

## THERMAL LUNCH BAG "TAKE AWAY"

MOD. 910N



- Flexible lunch bag with thermal insulation effect.
- Modern and cool design, with handle and shoulder strap.
- Interior PEVA: plastic insulation, environmentally friendly, toxic free. Anti bacteria. Easy to clean.
- Hygienic and healthy, complied with EU10/2011 and EN71-3 standards.
- BPA free.
- Pocket and mesh bag inside.
- Clic tite® airproof food storages, easy to open with Easy Clips®.
  - Total capacity: 2.200 ml.
  - Microwave (+120 °C) and freezer (-18 °C) safe.
  - Dishwasher safe.
- Size: 22 x 12 x 23 cm.

## THERMAL LUNCH BAG "TAKE AWAY"

MOD. 951



- Flexible lunch bag.
- Modern and cool design. With handle and shoulder strap.
- Aluminium foil lining interior: insulation material, environmentally friendly, toxic free. Anti bacteria. Easy to clean.
- Hygienic and healthy, complied with FDA standard.
- BPA free.
- 2 outer compartments.
- 2 hermetic containers, easy opening. Total capacity 2.200 ml.
  - Suitable for solids and liquids.
  - Microwave (+120 °C) and freezer (-18 °C) safe.
  - Dishwasher safe.
- Measures: 22 x 20 x 16 cm.

## THERMAL LUNCH BAG "TAKE AWAY"

MOD. 952



- Flexible lunch bag with top and bottom rigid.
- Modern and cool design, with handle and shoulder strap.
- Hygienic and healthy, complied with FDA standard.
- BPA free.
- Aluminium foil lining interior: insulation material, environmentally friendly, toxic free. Anti bacteria. Easy to clean.
- Mesh bag inside.
- Measures: 22 x 16 x 16 cm.

## THERMAL LUNCH BAG "TAKE AWAY"

MOD. 954



- Flexible lunch bag.
- Modern and cool design with shoulder strap.
- Aluminium foil lining interior: Therma-Flect® Ultra safe™ insulation material, environmentally friendly, toxic free. Anti bacteria. Easy to clean.
- Hygienic and healthy, complied with FDA standard.
- BPA free.
- 3 outer pockets.
- Extensible upper compartment up to 8 cm.
- 2 "Airtight" hermetic containers, easy opening. Total capacity 2.600 ml.
  - Suitable for solids and liquids.
  - Microwave (+120 °C) and freezer (-18 °C) safe.
  - Dishwasher safe.
- Measures: 23 x 15 x 22 cm.

## COOLER BAG "TAKE AWAY"

MOD. 970



- Flexible cooler bag.
- Capacity 15 L.
- Modern and cool design, with handle and shoulder strap.
- Aluminium foil lining interior: insulation material, environmentally friendly, toxic free. Anti bacteria. Easy to clean.
- Top flap for easy access.
- Hygienic and healthy, complied with FDA standard.
- BPA free.
- 3 outer compartments.
- Measures: 31 x 24 x 22 cm.

## NEW COOLER BAG "TAKE AWAY"

MOD. 980



- Flexible cooler bag.
- Capacity 19,5 L.
- Modern and cool design, with handle and shoulder strap.
- Aluminium foil lining interior: insulation material, environmentally friendly, toxic free. Anti bacteria. Easy to clean.
- Hygienic and healthy, complied with FDA standard.
- BPA free.
- 3 outer compartments.
- Interior compartment.
- Adjustable elastic rope.
- Measures: 32 x 26 x 34 cm.

## NEW COOLER TROLLEY "TAKE AWAY"

MOD. 990



- Flexible cooler bag.
- Capacity 23 L.
- Extensible handle.
- Aluminium foil lining interior: insulation material, environmentally friendly, toxic free. Anti bacteria. Easy to clean.
- Top flap for easy access.
- Modern and cool design, with handle and big size wheels.
- Hygienic and healthy, complied with FDA standard.
- BPA free.
- Outer compartment.
- Measures: 30 x 30 x 41 cm.



## NEW FOLDABLE BAG TROLLEY

MOD. 992



- Foldable bag trolley with carry handle. Capacity 30 L.
- Aluminum foil interior: insulation material, environmentally friendly and toxic free. Antibacteria. Easy cleaning.
- Extra strong, AZO-free polyester exterior material (textile dye without chemical components).

- Extra-resistant folding wheels.
- Main compartment with zipper closure.
- Outer pocket.
- Supports up to 15 kg.
- Transport handle.
- Open size: 34 x 18 x 70 cm.
- Folded size: 34 x 6 x 18 cm.

## NEW FOLDABLE BAG TROLLEY

MOD. 994



- Compact folding bag with carry handle. Capacity 30 L.
- Aluminum foil interior: insulation material, environmentally friendly and toxic free. Antibacteria. Easy cleaning.
- Extra strong, AZO-free polyester exterior material (textile dye without chemical components).

- Extra-resistant folding wheels.
- Main compartment with locking clip.
- External compartment with pocket. Measurements: 31 x 8 x 20 cm.
- Supports up to 15 kg.
- Transport handle.
- Open size: 32 x 27 x 70 cm.
- Folded size: 33 x 8 x 21 cm.

## NEW FOOD COOLER BAGS WITH INTEGRATED REFRIGERANT

MOD. 926 - 927 - 928



- Food cooler bags with integrated refrigerant gel.
- Direct to the freezer. Fully foldable.
- It keeps the same temperature for hours.
- Aluminium foil lining interior: insulation material, environmentally friendly, toxic free. Anti bacteria.

- Easy to clean.
- Hygienic and healthy, complied with FDA standard.
- BPA free.
- With shoulder strap for easy transport.
- Outer compartment.
- Easy to store, fully foldable.

Measures	Model	Capacity
22 x 14 x 17 cm	926	5 L
25 x 14 x 26 cm	927	8 L
25 x 22 x 27 cm	928	12 L

## NEW BOTTLE HOLDER COOLING BAG WITH INTEGRATED REFRIGERANT

MOD. 923



- Bottle cooler with integrated refrigerant gel.
- Direct to the freezer. Fully foldable.
- Especially created for bottles and cans. Suitable for 1 bottle of 2 litres vertically.
- Aluminium foil lining interior: insulation material, environmentally friendly, toxic free. Anti bacteria. Easy to clean.

- Hygienic and healthy, complied with FDA standard.
- BPA free.
- With handle and shoulder strap for easy transport.
- Outer compartment.
- Easy to store, fully foldable.
- Measures: Height 37 cm. Diameter 14 cm.
- It keeps the same temperature for hours.

## KITCHEN MOULDS

MOD. MC



- Platinum silicone mould, non-stick, flexible and easy to unmold.
- Free of BPA. Uniform cooking.
- Suitable for oven, freezer, microwave and dishwasher.
- Resistant to extreme temperatures: up to 240 °C and 50 °C below zero.

Model	Measures	Height	Uses
MC60	Ø 26 cm	3 cm	Special cakes
MC61	Ø 21 cm	10 cm	Special cakes
MC62	6 cups Ø 6 cm	3 cm	For muffins
MC63	Rectangular: 24 x 10 cm	6,5 cm	For baking and cooking
MC64	20 x 19 cm	4,5 cm	For baking and cooking
MC65	Ø 23 cm	6 cm	For baking and cooking
MC66	24 x 13 cm	5,5 cm	Special papillote and steam cooking
MC67	Set of 6 flans Ø 7,5 cm	5,5 cm	For baking and cooking
MC68	23 x 18 cm	4,5 cm	For baking and cooking

## STEP LADDER / IRONING BOARD

MOD. 848N



- Metallic paint, high resistance against rusty.
- Easy change step ladder / ironing board.
- Ironing surface: 95 x 34 cm. Height ironing board: 83 cm.
- 100% cotton cover.
- 5 mm felt underlay thickness.
- 1 mm mesh thickness.
- Iron rest suitable for steam boilers, measures 32 x 21 cm.
- 3 steps ladder, high stability. Height 70 cm.
- Tube diameter 22 mm.
- According to the standard EN131-2.

## STEP LADDER / IRONING BOARD

MOD. 848S



- Easy change ladder / ironing board.
- 3 steps ladder, high stability. Height 70 cm.
- Ironing surface: 107 x 34 cm. Height ironing board: 85 cm.
- Iron rest with security rail of 32 x 21 cm.
- 100% cotton cover.
- Iron rest suitable for steam boilers.
- 5 mm. felt underlay thickness.
- 1,2 mm. mesh thickness.
- Tube diameter 22 mm.
- According to the standard EN131-2

## EASY IRON

MOD. 800



- It allows faster, easier ironing without leaving bright patches on delicate fabrics.
- It is made of non-stick material resistant to temperatures up to 250 °C.
- Made in Spain
- It will adapt to all the irons on the market.
- The non-stick is designed to distribute evenly the steam generated by the iron.
- Universal design.

## IRONING BOARD "VITAL"

MOD. TP500



- Ironing surface 116 x 35 cm.
- Thermo lacquered structure. Highly resistant to oxidation.
- Ergonomic platform made in mesh.
- Multi adjustable height positions up to 90 cm.
- Safety closing device.
- Non-slip feet. 100% cotton case.
- "Y" leg system that provides an optimum stability.
- Tube diameters 30 / 22 mm.
- Mesh thickness 0,9 mm.
- Pad thickness 5 mm.
- Iron rest. Measurements 29 x 20 cm.
- Measurements folded 137 x 35 x 6 cm.

## IRONING BOARD "COMPACT"

MOD. TP520



- Ironing surface 124 x 40 cm.
- Thermo lacquered structure. Highly resistant to oxidation.
- Ergonomic platform in expanded metal.
- Multi adjustable height positions up to 93 cm.
- Safety closing device.
- "Y" leg system that provides an optimum stability.
- 100% cotton case.
- Tube diameters 30 / 22 mm.
- Mesh thickness 0,9 mm.
- Pad thickness 5 mm.
- Non-slip feet.
- Iron rest suitable for steam stations. Measurements 44 x 27 cm.
- Measurements folded 151 x 44 x 7 cm.

## SLEEVE BOARD

MOD. TM200



- Ironing surface 50 x 10 cm.
- 100% cotton cover with pad.
- Thermo lacquered structure. Highly resistant to oxidation.

## IRONING BOARD "SUPREMA"

MOD. TP550



- Ironing surface 130 x 47 cm.
- Thermo lacquered structure. Highly resistant to oxidation.
- Ergonomic platform in expanded metal.
- Multi adjustable height positions up to 95 cm.
- Safety closing device.
- "Y" leg system that provides a great stability.
- Wheels for easy movement.
- Adjustable support to ensure optimum stability.
- 100% cotton case / Non-slip feet.
- Reinforced tube. Tube diameter 35 mm.
- Mesh thickness 1 mm.
- Pad thickness 8 mm.
- Iron rest suitable for steam stations. Measurements 44 x 27 cm.
- Measurements folded 157 x 47 x 7 cm.

## IRONING BOARD "OPTIMA XL PRO"

MOD. TP600



- Ironing surface 137 x 45 cm.
- Aluminium structure with anti-corrosion treatment (cataphoresis).
- Foldable for easy storage.
- Ergonomic platform in expanded metal.
- Multi adjustable height positions up to 93 cm.
- High resistance, up to 40 kg.
- Safety closing device.
- "Y" leg system that provides a great stability.
- Wheels for easy movement.
- Adjustable support to ensure optimum stability.
- 100% cotton cover with integrated pad.
- Reinforced tube 50 x 25 mm.
- Mesh thickness 1 mm.
- Support for steam irons 38 x 34 cm.
- Removable iron rest. Non-slip feet.
- Measurements folded 114 x 46 x 13 cm.

NUESTRA PÁGINA WEB

www.jata.es



### APTA PARA TODOS LOS DISPOSITIVOS

Nuestra web corporativa tiene un atractivo diseño compatible con cualquier dispositivo y con toda la información sobre nuestra amplia gama de productos.



### FÁCIL NAVEGACIÓN

Mediante nuestro site queremos ofrecer a nuestros clientes una mejora en la experiencia de navegación.

### DESCARGA DE IMÁGENES

Ofrecemos la posibilidad de consultar de forma más rápida y sencilla todos los productos que ofertamos, dando la posibilidad de descarga de imágenes en alta resolución (especialmente indicado para uso profesional).

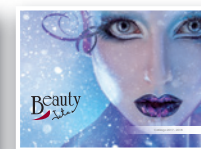

CATÁLOGOS GRUPO JATA







## DECA, S.A.

Distribución de Equipos para la Casa, S.A.

### ADMINISTRACIÓN

Zubibitarte 6  
48220 Abadiano  
Bizkaia

### OFICINA COMERCIAL

Francesc Layret, 75, piso 9º, Ofic. 4  
08100, Mollet del Vallès, Barcelona  
Tel: (34) 94 681 61 44  
Fax: (34) 94 681 44 44  
comercial@jata-hogar.es  
www.jata.es

### PORTUGAL

Avenida Engenheiro Duarte Pacheco,  
Torre 2-3º, Sala 3 1070-102, Lisboa  
Tel: (351) 213 876 355  
Fax: (351) 213 867 398  
geral@jata.pt  
www.jata.pt

