

ZYXEL

Your Networking Ally

User's Guide

ARMOR G1

AC2600 Multi-Gigabit Security WiFi Router
Model: NBG6818

Default Login Details

LAN IP Address	http://zyxelwifi.com OR http://zyxelwifi.net
----------------	--

Version 1.00 Edition 2, 08/2020



IMPORTANT!

READ CAREFULLY BEFORE USE.

KEEP THIS GUIDE FOR FUTURE REFERENCE.

Screenshots and graphics in this book may differ slightly from your product due to differences in your product firmware or your computer operating system. Every effort has been made to ensure that the information in this manual is accurate.

Related Documentation

- Quick Start Guide

The Quick Start Guide shows how to connect the NBG6818 and access the Web Configurator wizards. It contains information on setting up your network and configuring for Internet access.

- More Information

Go to support.zyxel.com to find other information on the NBG6818.



Document Conventions

Warnings and Notes

These are how warnings and notes are shown in this guide.

Warnings tell you about things that could harm you or your device.









Note: Notes tell you other important information (for example, other things you may need to configure or helpful tips) or recommendations.

Syntax Conventions

- Product labels, screen names, field labels and field choices are all in **bold** font.
- A right angle bracket (>) within a screen name denotes a mouse click. For example, **Setting > Internet > Internet Connection** means you first click **Setting** in the navigation panel, then the **Internet** sub menu and finally the **Internet Connection** tab to get to that screen.

Icons Used in Figures

Figures in this user guide may use the following generic icons. The NBG6818 icon is not an exact representation of your device.

NBG6818 	Wireless Device 	Laptop Computer 
Switch 	Firewall 	Server 
Internet 	Desktop Computer 	Smartphone 

Contents Overview

User's Guide	10
Introduction	11
Wizard	17
The Web Configurator	27
NBG6818 Modes	34
Standard Mode	36
.....	38
Bridge Mode	39
Tutorials	42
Technical Reference	55
Applications	56
WAN	77
Wireless LAN	102
LAN	113
Security	123
System	130
Troubleshooting	141

Table of Contents

Document Conventions	3
Contents Overview	4
Table of Contents	5
Part I: User's Guide.....	10
Chapter 1	
Introduction	11
1.1 Overview	11
1.2 Applications	11
1.3 Ways to Manage the NBG6818	12
1.4 Good Habits for Managing the NBG6818	12
1.5 Resetting the NBG6818	13
1.5.1 How to Use the RESET Button	13
1.6 The WPS Button	13
1.7 LEDs	14
1.8 Desk Mounting	15
1.9 Wall Mounting	15
Chapter 2	
Wizard	17
2.1 Overview	17
2.2 Accessing the Wizard	17
Chapter 3	
The Web Configurator.....	27
3.1 Overview	27
3.2 Accessing the Web Configurator	27
3.3 Navigation Panel	29
3.3.1 Standard Mode Navigation Panel	30
3.3.2 Bridge Mode Navigation Panel	32
Chapter 4	
NBG6818 Modes.....	34
4.1 Overview	34
4.2 Modes	34

Chapter 5
Standard Mode36

 5.1 Overview 36

 5.2 What You Can Do 36

 5.3 Standard Mode Status Screen 36

.....38

Chapter 6
Bridge Mode.....39

 6.1 Overview 39

 6.2 What You Can Do 39

 6.3 Setting your NBG6818 to Bridge Mode 39

 6.3.1 Accessing the Web Configurator in Bridge Mode 40

 6.4 Bridge Mode Status Screen 41

Chapter 7
Tutorials42

 7.1 Overview 42

 7.2 Run a Speed Test 42

 7.3 Configure the NBG6818's WiFi Networks 43

 7.4 Enable or Disable a WiFi Network 45

 7.5 Add Clients to a Profile 46

 7.6 Set a Profile's WiFi Schedule 47

 7.7 Pause or Resume Internet Access on a Profile 49

 7.8 Turn on or off the NBG6818's LED (Light) 50

 7.9 Change Your NBG6818 Operating Mode 51

 7.10 Configure a Port Forwarding Rule 52

Part II: Technical Reference..... 55

Chapter 8
Applications56

 8.1 Overview 56

 8.1.1 What You Can Do 56

 8.1.2 What You Need To Know 56

 8.1.3 Before You Begin 57

 8.2 Parental Control 57

 8.2.1 Device Screen 57

 8.3 OpenVPN Server/Client 61

 8.3.1 OpenVPN Server Screen 61

 8.3.2 OpenVPN Account Screen 63

8.3.3 OpenVPN Client Screen	65
8.4 USB Application	67
8.4.1 SAMBA Server Screen	67
8.4.2 FTP Server Screen	69
8.4.3 USB Media Sharing Screen	71
8.5 Access Your Shared Files From a Computer	73
8.5.1 Using Windows Explorer	73
8.5.2 Using FTP Program	74
Chapter 9	
WAN	77
9.1 Overview	77
9.2 What You Can Do	77
9.3 What You Need To Know	78
9.3.1 Configuring Your Internet Connection	78
9.4 Internet Connection Screen	79
9.4.1 IPoE Encapsulation	79
9.4.2 PPPoE Encapsulation	82
9.4.3 PPTP Encapsulation	85
9.5 NAT & Port Forwarding Screen	87
9.5.1 Add Port Forwarding Rule Screen	89
9.6 Passthrough Screen	91
9.7 Port Trigger Screen	92
9.7.1 Add Port Trigger Rule Screen	94
9.8 Dynamic DNS Screen	95
9.9 UPnP Screen	96
9.9.1 Turning On UPnP in Windows 7 Example	97
9.9.2 Turning on UPnP in Windows 10 Example	99
Chapter 10	
Wireless LAN	102
10.1 Overview	102
10.1.1 What You Can Do	102
10.1.2 What You Should Know	103
10.2 Main WiFi Screen	106
10.3 Guest WiFi Screen	108
10.4 MAC Filter Screen	108
10.4.1 Add MAC Address Screen	109
10.5 WPS Screen	110
10.6 Scheduling Screen	112
Chapter 11	
LAN	113

11.1 Overview	113
11.2 What You Can Do	113
11.3 What You Need To Know	113
11.4 LAN IP Screen	114
11.4.1 Static DHCP Table-Add/Edit Rule Screen	117
11.4.2 Configure LAN Screen in Bridge Mode	119
11.5 IPv6 LAN Screen	120
Chapter 12	
Security	123
12.1 Overview	123
12.1.1 What You Can Do	123
12.1.2 What You Need To Know	123
12.2 IPv4 Firewall Screen	124
12.2.1 IPv4 Firewall-Add Rule Screen	126
12.3 IPv6 Firewall Screen	127
12.3.1 IPv6 Firewall-Add Rule Screen	128
Chapter 13	
System.....	130
13.1 Overview	130
13.2 What You Can Do	130
13.3 Status Screen	130
13.4 General Setting Screen	133
13.5 Remote Access Screen	135
13.6 Maintenance Screen	136
13.7 Operating Mode Screen	137
13.8 Logs Screen	139
Chapter 14	
Troubleshooting.....	141
14.1 Overview	141
14.2 Power, Hardware Connections, and LEDs	141
14.3 NBG6818 Access and Login	142
14.4 Internet Access	143
14.5 Resetting the NBG6818 to Its Factory Defaults	144
14.6 Wireless Connections	144
14.7 USB Device Problems	146
Appendix A Customer Support	147
Appendix B Setting Up Your Computer's IP Address.....	153
Appendix C Common Services	172

Appendix D Legal Information 175

Index181

PART I

User's Guide

CHAPTER 1

Introduction

1.1 Overview

This chapter introduces the main features and applications of the NBG6818, also called ARMOR G1.

The NBG6818 extends the range of your existing wired network without additional wiring, providing easy network access to mobile users. You can set up a wireless network with other IEEE 802.11a/b/g/n/ac compatible devices. The NBG6818 is able to function both 2.4GHz and 5GHz networks at the same time.

A range of services such as a firewall and content filtering are also available for secure Internet computing.

There is an USB port on the side panel of your NBG6818. You can connect an USB memory stick, an USB hard drive, or an USB device for file sharing. The NBG6818 automatically detects the USB device.

1.2 Applications

You can have the following networks with the NBG6818:

- **Wired.** You can connect network devices via the Ethernet ports of the NBG6818 so that they can communicate with each other and access the Internet.

Figure 1 Internet Access Application: Wired Connection

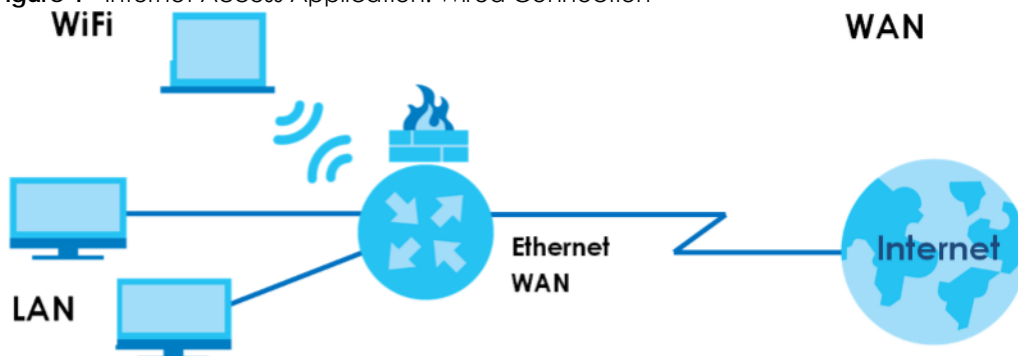

- **Wireless.** Wireless clients can connect to the NBG6818 to access network resources. You can use WPS (Wi-Fi Protected Setup) to create an instant network connection with another WPS-compatible device.

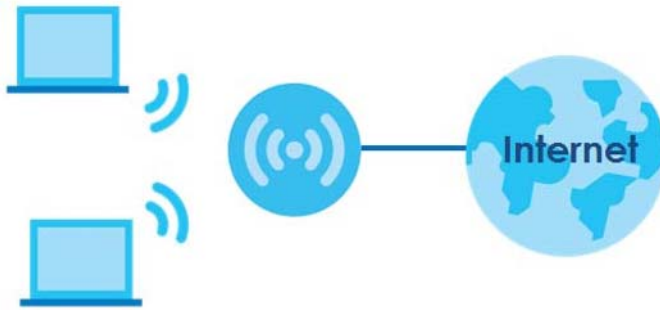
Figure 2 Internet Access Application: Wireless Connection

- **WAN.** Connect to a broadband modem/router for Internet access.

Figure 3 Internet Access Application: Ethernet WAN

1.3 Ways to Manage the NBG6818

Use the following method to manage the NBG6818.

- **Web Configurator.** This is recommended for everyday management of the NBG6818 using a (supported) web browser.
- **Zyxel ARMOR.** This is the app you can use to manage the NBG6818 on your cellphone. To install the app, scan the QR code on the QSG.

1.4 Good Habits for Managing the NBG6818

Do the following things regularly to make the NBG6818 more secure and to manage the NBG6818 more effectively.

- **Change the password.** Use a password that's not easy to guess and that consists of different types of characters, such as numbers and letters.
- **Write down the password and put it in a safe place.**
- **Back up the configuration (and make sure you know how to restore it).** Restoring an earlier working configuration may be useful if the device becomes unstable or even crashes. If you forget your password, you will have to reset the NBG6818 to its factory default settings. If you backed up an earlier configuration file, you would not have to totally re-configure the NBG6818. You could simply restore your last configuration.

1.5 Resetting the NBG6818

If you forget your password or IP address, or you cannot access the Web Configurator, insert a thin object into the **Reset** hole on the side of the NBG6818 to reload the factory-default configuration file. This means that you will lose all settings that you had previously saved.

1.5.1 How to Use the RESET Button

- 1 Make sure the power LED is on.
- 2 Locate the **Reset** hole.
- 3 Insert a thin object into the **Reset** hole for longer than eight seconds to reset the NBG6818 back to its factory-default configuration.

1.6 The WPS Button

Your NBG6818 supports Wi-Fi Protected Setup (WPS), which is an easy way to set up a secure wireless network. WPS is an industry standard specification, defined by the Wi-Fi Alliance.

WPS allows you to quickly set up a wireless network with strong security, without having to configure security settings manually. Each WPS connection works between two devices. Both devices must support WPS (check each device's documentation to make sure).

Depending on the devices you have, you can either press a button (on the device itself, or in its configuration utility) or enter a PIN (a unique Personal Identification Number that allows one device to authenticate the other) in each of the two devices. When WPS is activated on a device, it has two minutes to find another device that also has WPS activated. Then, the two devices connect and set up a secure network by themselves.

You can use the WPS button in the Web Configurator of the NBG6818 to activate WPS in order to quickly set up a wireless network with strong security.

- 1 Make sure the power LED is on (not blinking).
- 2 Open the Web Configurator.
- 3 Click **Settings > WiFi > WPS**, and then press the WPS button.
- 4 Press the WPS button on another WPS-enabled device within range of the NBG6818.

Note: You must activate WPS in the NBG6818 and in another wireless device within two minutes of each other.

For more information on using WPS, see [Section 7.2 on page 42](#).

1.7 LEDs

Figure 4 Front Panel

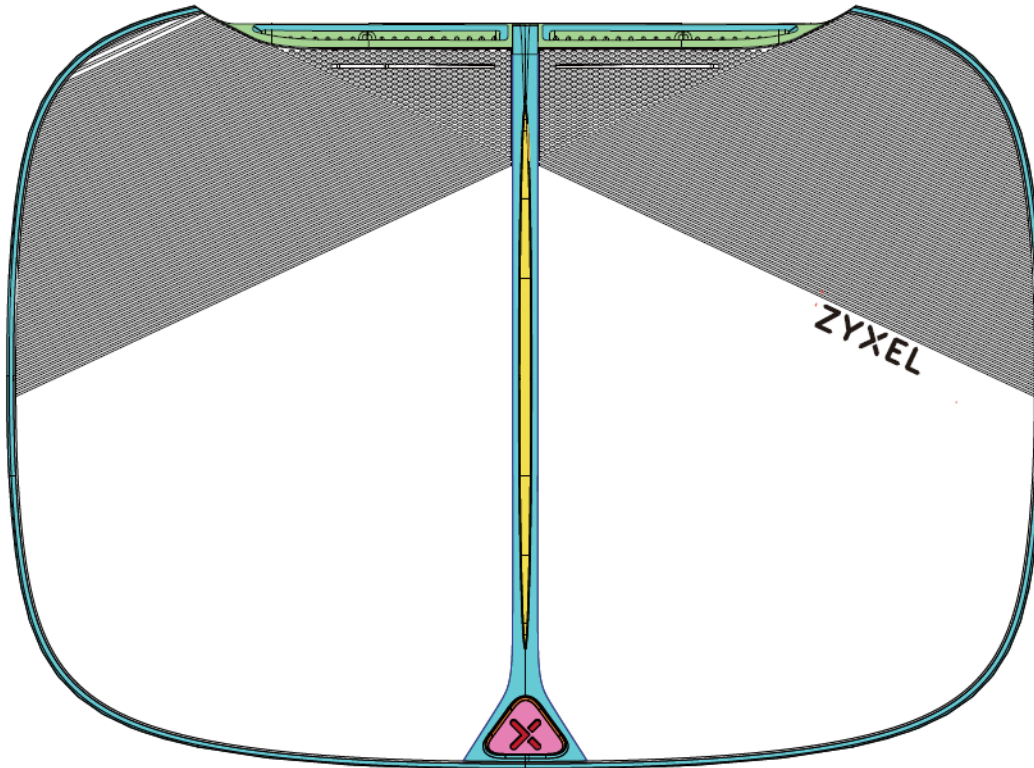

The following table describes the front panel LED.

Table 1 Front Panel LED

COLOR	STATUS	DESCRIPTION
White	On	The NBG6818 is receiving power.
	Blinking	The NBG6818 is booting.
Dark Blue	On	Blue tooth is ready.
	Blinking	Blue tooth configuration is in process.
Amber	Blinking (Slow)	The NBG6818 is upgrading firmware.
	Blinking (Fast)	The NBG6818 is resetting.
Purple	Blinking	WPS configuration is in process.
Purple and Dark Blue	Blinking	The NBG6818 is receiving power and ready for use.
Red	On	The NBG6818 detects an error while self-testing, or there is a device malfunction.

Figure 5 Rear Panel

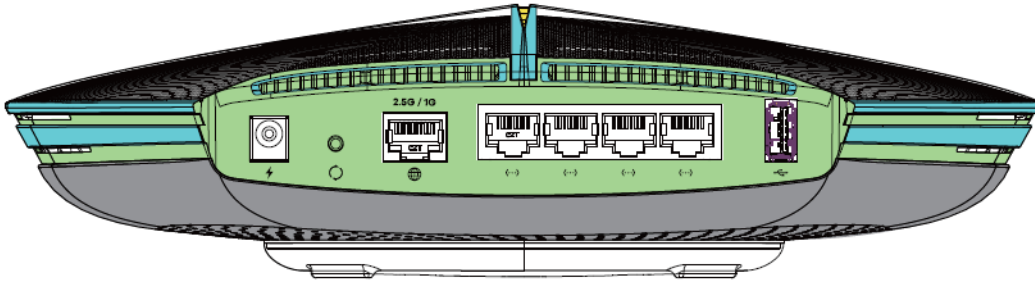

1.8 Desk Mounting

Place the side of the NBG6818 with rubber feet carefully on the desk.

1.9 Wall Mounting

You may need screw anchors if mounting on a concrete or brick wall.

Table 2 Wall Mounting Information

Distance between holes	10.50 cm
M4 Screws	Two
Screw anchors (optional)	Two

Figure 6 Screw Specifications

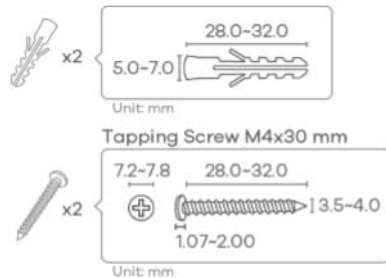

- 1 Select a position free of obstructions on a wall strong enough to hold the weight of the device.
 - 2 Mark two holes on the wall at the appropriate distance apart for the screws.
- Be careful to avoid damaging pipes or cables located inside the wall when drilling holes for the screws.**
- 3 If using screw anchors, drill two holes for the screw anchors into the wall. Push the anchors into the full depth of the holes, then insert the screws into the anchors. Do not insert the screws all the way in - leave a small gap of about 0.5 cm.

If not using screw anchors, use a screwdriver to insert the screws into the wall. Do not insert the screws all the way in - leave a gap of about 0.5 cm.

- 4 Make sure the screws are fastened well enough to hold the weight of the NBG6818 with the connection cables.
- 5 Remove the rubber feet.
- 6 Align the holes on the back of the NBG6818 with the screws on the wall. Hang the NBG6818 on the screws.

Figure 7 Wall Mounting- Rubber Feet

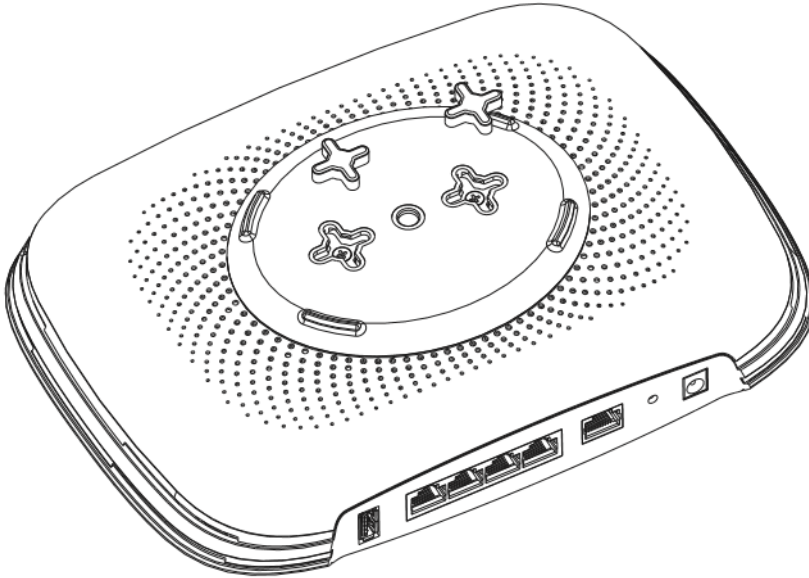

CHAPTER 2

Wizard

2.1 Overview

In this chapter, you will learn how to:

- Go through NBG6818 (ARMOR G1) wizard steps
- Configure basic settings for your WiFi
- Create a myZykel Cloud account.

2.2 Accessing the Wizard

Launch your web browser and type "http://zyxelwifi.com" or "http://zyxelwifi.net" as the website address.

Note: The wizard appears automatically when the NBG6818 is accessed for the first time or when you reset the NBG6818 to its default factory settings.

- 1 Your NBG6818 will check the status of your Internet connection the first time you log in.



- 2 The following screen shows if you are connected to the Internet. Click **Next** to go to the next step in the wizard.

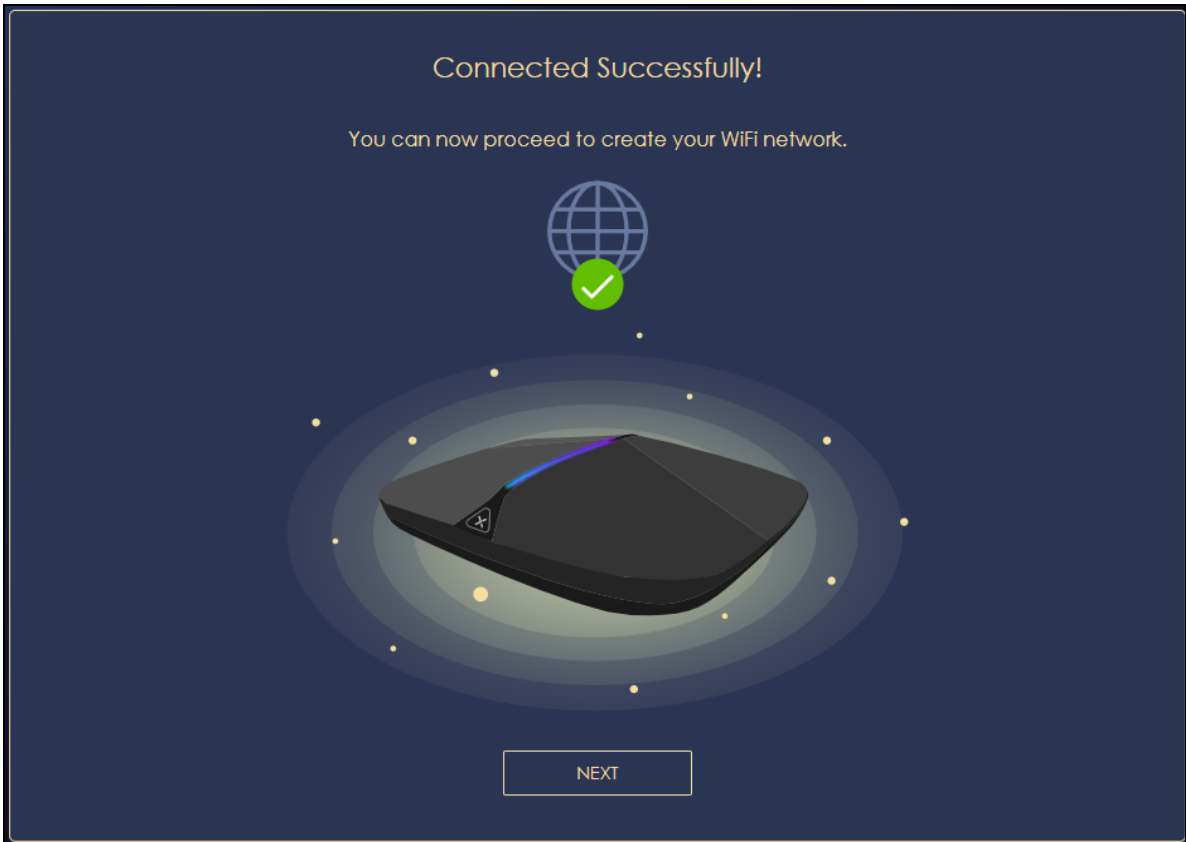

The following screen shows if you are not connected to the Internet.

Note: You may need to turn off your network firewall if access to the Internet from the NBG6818 is blocked.

You need to connect to the Internet to access your NBG6818. See [Section 14.4 on page 143](#) if you cannot connect to the Internet.

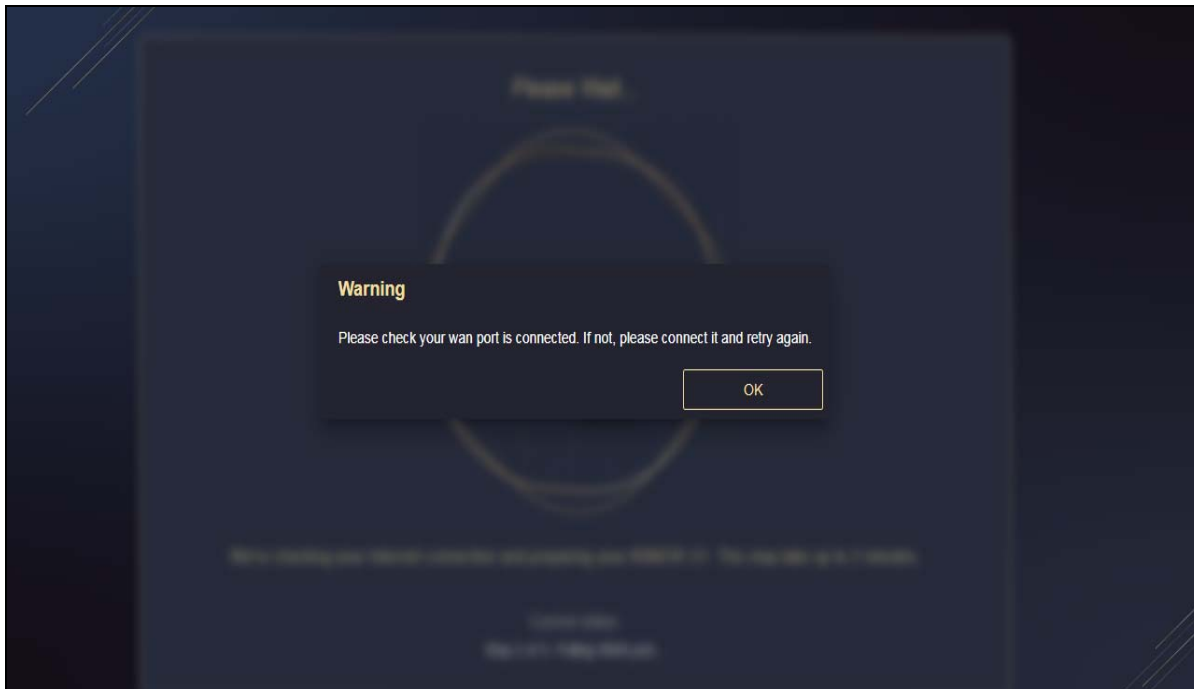

- 3 Enter 1-128 single-byte printable ASCII characters but not ""<>^\$& as your **2.4G/5G WiFi Name** and **WiFi Password**. Select the check box **Keep 2.4G & 5G name the same** if you want to use the same name for your 2.4G and 5G WiFi.

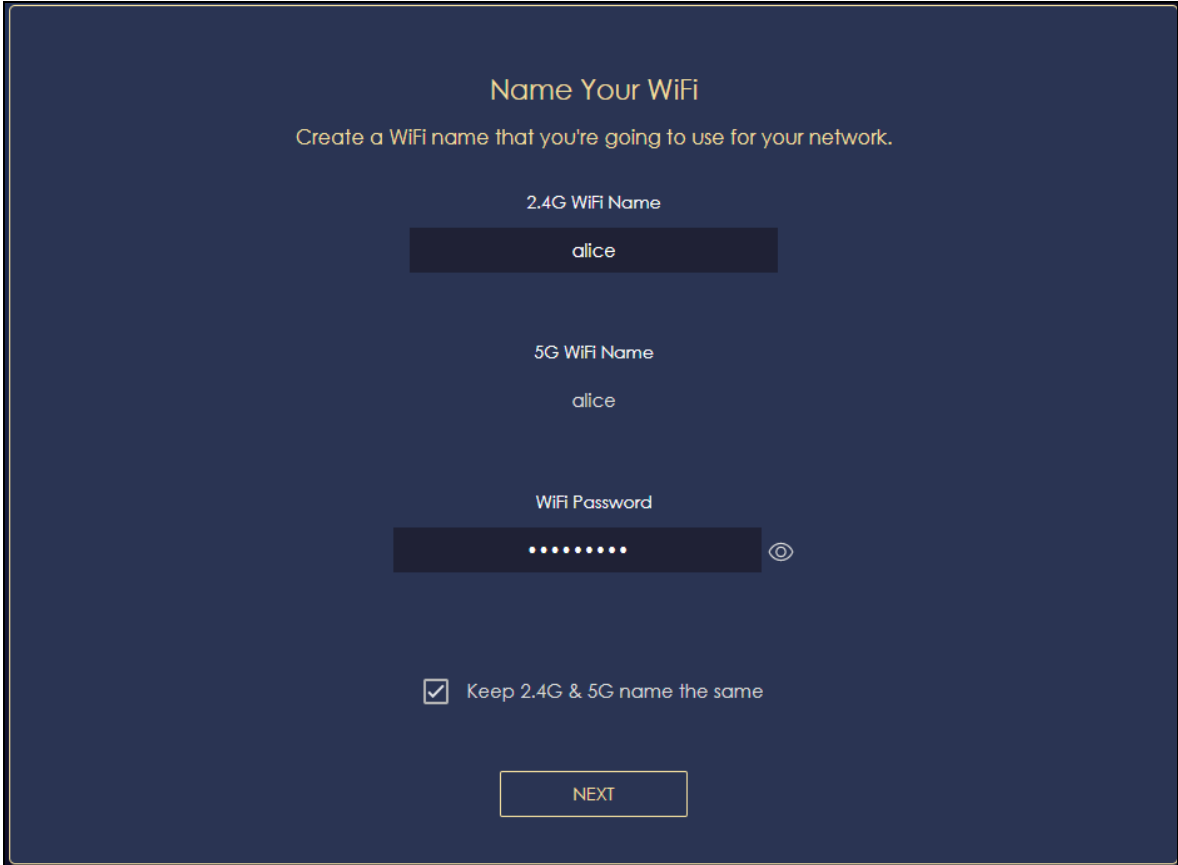

- 4 Wait a moment for your WiFi settings to be applied to your NBG6818.

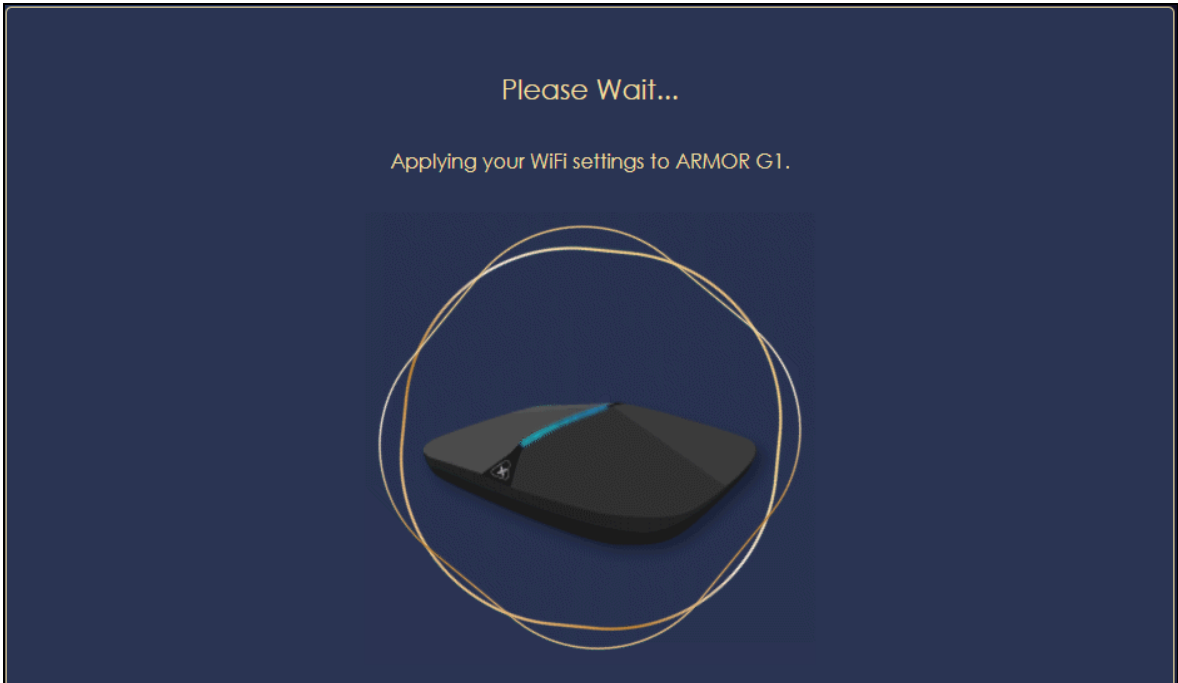

- 5 The following screen shows if you have set up your WiFi name and password successfully. Click **Next** to go to the next step in the wizard.



- 6 Wait a moment for the NBG6818 to check if your device is updated with the latest firmware. If not, your NBG6818 will automatically update the firmware.



- 7 You need to create a myZyxel Cloud account to log into the NBG6818. Click **Next** to go to the next step in the wizard.



- 8 A pop up message shows. Click **OK** to be redirected to the registration website of myZyxel Cloud.

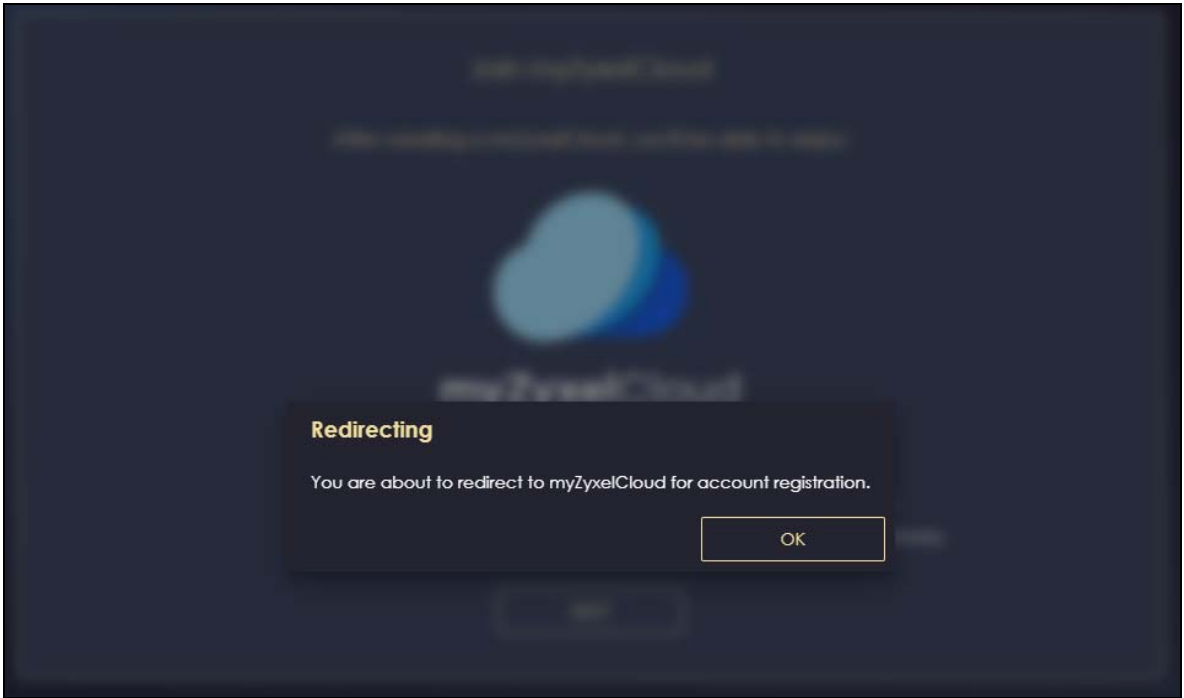

- 9 Enter your **Email** and **Password** if you already have a myZyxe Cloud account. If not, you can create one by clicking **Sign Up**. You can also click the Facebook or Google icon to create an account with your Facebook or Google account.

Log in with
myZyxeCloud account

Email

Password

You need to sign in or sign up before continuing.

Remember me

SIGN IN

or

[Sign Up](#) / [Forgot Password](#) / [Help](#)

Global / EN

© 2019 Zyxel Communications Corp.

- 10 The legal page shows after you log in. Select the check box **I understand and agree the Zyxel Cloud Terms of Use** and then click **Confirm**.

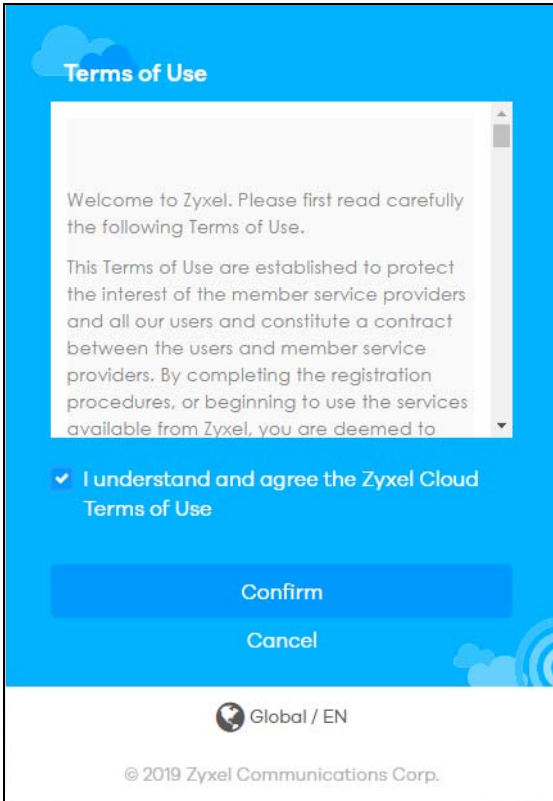

- 11 The following page asks for your authorization to use your account. Click **Authorize** to finish registering your myZyxel Cloud account. You will be directed back to the NBG6818 web configurator.

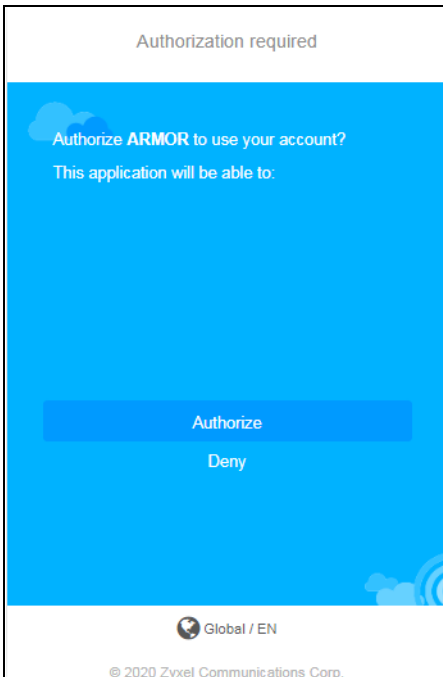

- 12 Wait a moment for your NBG6818 to link to your myZyxel Cloud account.

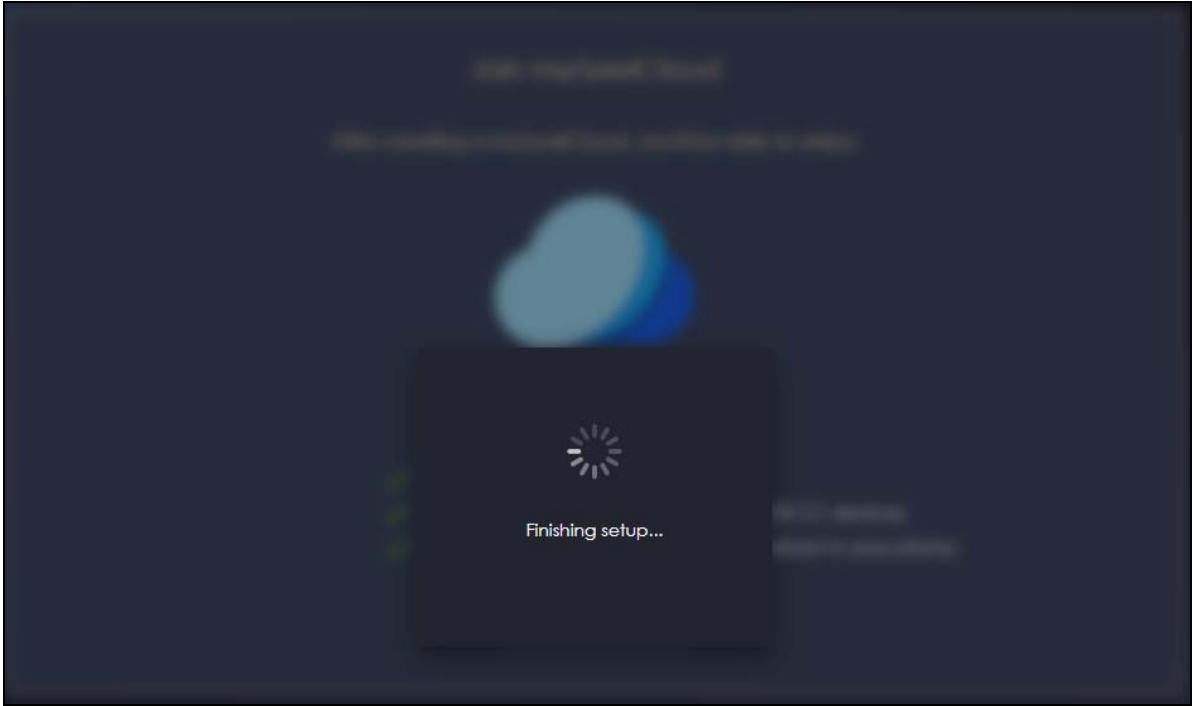

- 13** You can create a local password to access the NBG6818 directly. You can choose to log in with your myZykel Cloud account or your local password the next time you log in.

Note: You can change your local password in **System > General Settings**. See [Section 13.4 on page 133](#) for more information.

A screenshot of a dark blue web interface for setting a device login password. The title is "Device Login password" in orange. Below it, the text "Please create your local password for device login" is displayed. There are two input fields: "Password" and "Confirm Password", both with black backgrounds and white text. To the right of each field is a small white eye icon. At the bottom center, there is a white button with the text "APPLY" in orange.

CHAPTER 3

The Web Configurator

3.1 Overview

This chapter describes how to access the NBG6818 Web Configurator and provides an overview of its screens.

The Web Configurator is an HTML-based management interface that allows easy system setup and management via Internet browser. Use a browser that supports HTML5, such as Mozilla Firefox, or Google Chrome. The recommended screen resolution is 1024 by 768 pixels.

In order to use the Web Configurator you need to allow:

- Web browser pop-up windows from your device.
- JavaScript (enabled by default).
- Java permissions (enabled by default).

3.2 Accessing the Web Configurator

- 1 Make sure your NBG6818 hardware is properly connected (refer to the Quick Start Guide).
- 2 Launch your web browser.
- 3 If the NBG6818 is in **Standard Mode** (the default mode), enter "http://zyxelwifi.com" in the browser's address bar.
If the NBG6818 is in **Bridge Mode**, type "http:// (DHCP-assigned IP)" in the browser's address bar.
- 4 On the displayed login screen, log in using your myZyxeCloud username and password or the local password.

Note: If this is the first time you are accessing the web configurator or if the device has been reset, you must complete the setup wizard, see [Chapter 2 on page 17](#).

Note: For setting and changing the local password, see [Section 13.4 on page 133](#).



- 5 The NBG6818 **Overview** screen displays allowing you to monitor your NBG6818. It shows if the NBG6818 is online, and how many wireless clients are currently connected to your device, as well as their upstream/downstream data rates.

Figure 8 Overview (Standard Mode)

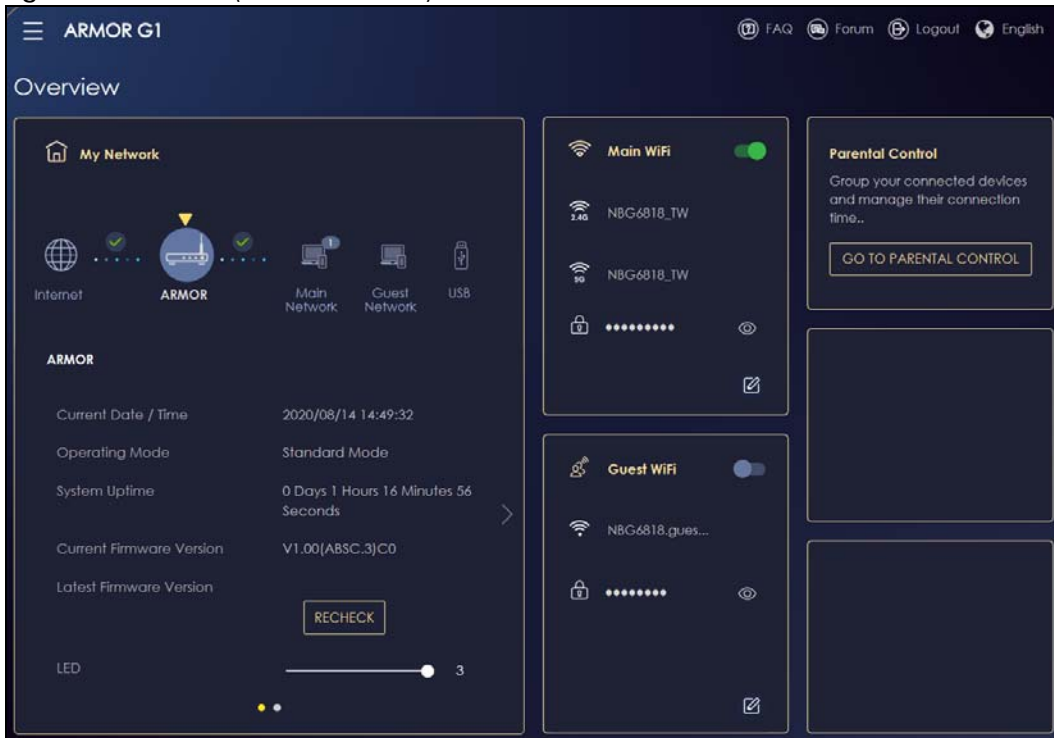
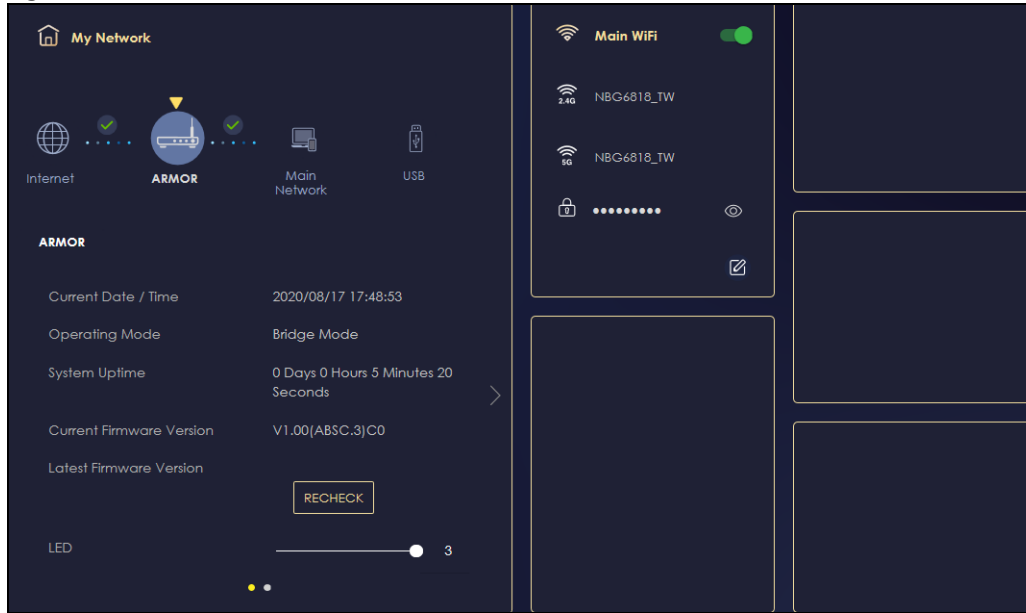

Figure 9 Overview (Bridge Mode)



3.3 Navigation Panel

Use the submenus on the navigation panel to configure NBG6818 features. Your navigation panel varies depending on the mode of your NBG6818.

See [Chapter 5 on page 36](#) for more information on Standard Mode.

See [Chapter 6 on page 39](#) for more information on Bridge Mode.

3.3.1 Standard Mode Navigation Panel

Figure 10 Navigation Panel (Standard Mode)

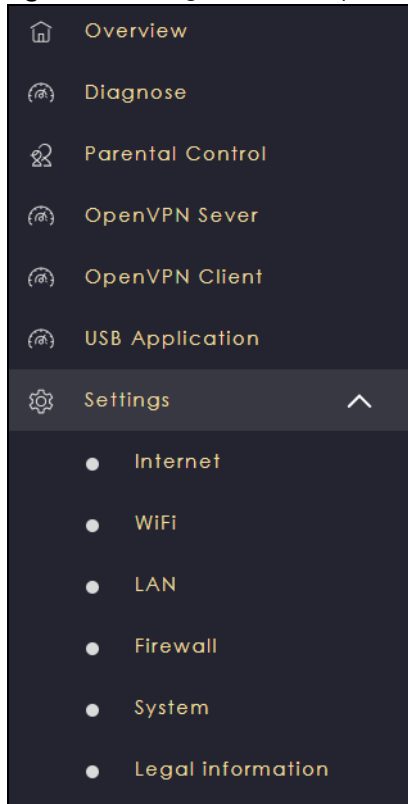

The following table describes the submenus.

Table 3 Settings > System > Status (Standard Mode)

LINK	TAB	FUNCTION
Overview		Use this screen to: <ul style="list-style-type: none"> • View read-only information about your NBG6818 • Configure WiFi settings • Change the brightness of your device's LED
Diagnose	Advanced Speed Test	Use this screen to check the speed of the connection between your NBG6818 and the broadband modem/router.
	Speed Test History	Use this screen to view a summary of previously run speed tests.
Parental Control	Device	Use this screen to: <ul style="list-style-type: none"> • View devices information • Add and configure parental control rules or schedules
	Profile	Use this screen to enable or configure existing parental control rules.
OpenVPN Server	OpenVPN Server	Use this screen to create and configure an OpenVPN server account.
	OpenVPN Account	Use this screen to: <ul style="list-style-type: none"> • View basic information about NBG6818 OpenVPN server • View basic information about clients that are connected to the NBG6818 OpenVPN server

Table 3 Settings > System > Status (Standard Mode) (continued)

LINK	TAB	FUNCTION
OpenVPN Client		Use this screen to: <ul style="list-style-type: none"> View basic information about OpenVPN Server accounts that you are connected to Add an OpenVPN Server Account you want your NBG6818 to connect to when the NBG6818 functions as an OpenVPN client.
USB Application	SAMBA	Use this screen to: <ul style="list-style-type: none"> Set up file-sharing via the NBG6818 using Windows Explorer or the workgroup name Configure the workgroup name and create file-sharing user accounts
	FTP	Use this screen to set up file sharing via the NBG6818 using FTP and create user accounts.
	USB Media Sharing	Use this screen to configure settings for media sharing.
Internet	Internet Connection	This screen allows you to configure ISP parameters, WAN IP address assignment, DNS servers and the WAN MAC address.
	NAT & Port Forwarding	Use this screen to enable NAT. Use this screen to configure servers behind the NBG6818 and forward incoming service requests to the servers on your local network.
	Passthrough	Use this screen to change your NBG6818's port triggering settings.
	Port Trigger	Use this screen to configure ALGs (Application Layer Gateway) and VPN pass-through settings.
	Dynamic DNS	Use this screen to configure dynamic DNS.
	UPnP	Use this screen to enable UPnP on the NBG6818.
WiFi	Main WiFi	Use this screen to enable the wireless LAN and configure wireless LAN and wireless security settings.
	Guest WiFi	Use this screen to configure multiple BSSs on the NBG6818.
	MAC Filter	Use the MAC filter screen to configure the NBG6818 to block access to devices or block the devices from accessing the NBG6818.
	WPS	Use this screen to configure WPS.
	Scheduling	Use this screen to schedule the times the Wireless LAN is enabled.
LAN	LAN IP	Use this screen to configure the NBG6818's LAN IP address and subnet mask. Use this screen to configure the IPv6 address for the NBG6818 on the LAN. Use this screen to enable the NBG6818's DHCP server.
	IPv6 LAN	Use this screen to configure the IPv6 address for your NBG6818 on the LAN.
Firewall	IPv4 Firewall	Use this screen to configure IPv4 firewall rules.
	IPv6 Firewall	Use this screen to configure IPv6 firewall rules.

Table 3 Settings > System > Status (Standard Mode) (continued)

LINK	TAB	FUNCTION
System	Status	Use this screen to view the basic information of the NBG6818
	General Setting	Use this screen to change password or to set the timeout period of the management session.
	Remote Access	Use this screen to configure the interface/s from which the NBG6818 can be managed remotely and specify a secure client that can manage the NBG6818.
	Maintenance	Use this screen to upload firmware, reboot the NBG6818 without turning the power off or reset the NBG6818 to factory default.
	Operating Mode	Use this screen to select whether your device acts as a router, or a bridge.
	Logs	Use this screen to view the list of activities recorded by your NBG6818.

3.3.2 Bridge Mode Navigation Panel

Figure 11 Navigation Panel (Bridge Mode)

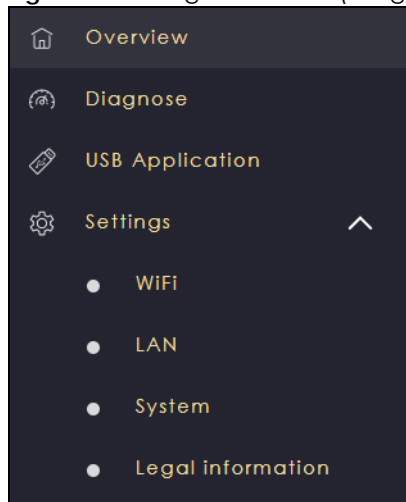

The following table describes the submenus.

Table 4 Settings > System > Status (Bridge Mode)

LINK	TAB	FUNCTION
Overview		Use this screen to: <ul style="list-style-type: none"> View read-only information about your NBG6818 Configure WiFi settings Change the brightness of your device's LED
Diagnose	Advanced Speed Test	Use this screen to check the speed of the connection between your NBG6818 and the broadband modem/router.
	Speed Test History	Use this screen to view a summary of previously run speed tests.

Table 4 Settings > System > Status (Bridge Mode) (continued)

LINK	TAB	FUNCTION
USB Application	SAMBA	Use this screen <ul style="list-style-type: none"> Set up file-sharing via the NBG6818 using Windows Explorer or the workgroup name Configure the workgroup name and create file-sharing user accounts
	FTP	Use this screen to set up file sharing via the NBG6818 using FTP and create user accounts.
	USB Media Sharing	Use this screen to configure settings for media sharing.
WiFi	Main WiFi	Use this screen to enable the wireless LAN and configure wireless LAN and wireless security settings.
	MAC Filter	Use the MAC filter screen to configure the NBG6818 to block access to devices or block the devices from accessing the NBG6818.
	WPS	Use this screen to configure WPS.
	Scheduling	Use this screen to schedule the times the Wireless LAN is enabled.
LAN	LAN IP	Use this screen to configure the NBG6818's LAN IP address and subnet mask.
		Use this screen to configure the IPv6 address for the NBG6818 on the LAN.
		Use this screen to enable the NBG6818's DHCP server.
System	Status	Use this screen to view the basic information of the NBG6818
	General Setting	Use this screen to change password or to set the timeout period of the management session.
	Remote Access	Use this screen to enable remote assistant.
	Maintenance	Use this screen to upload firmware, reboot the NBG6818 without turning the power off or reset the NBG6818 to factory default.
	Operating Mode	Use this screen to select whether your device acts as a router, or a bridge.
	Logs	Use this screen to view the list of activities recorded by your NBG6818.

CHAPTER 4

NBG6818 Modes

4.1 Overview

This chapter introduces the different operating modes available on your NBG6818. Or simply how the NBG6818 is being used in the network.

4.2 Modes

This refers to the operating mode of the NBG6818, which can act in:

- **Standard Mode:** This is the default device mode of the NBG6818. Use this mode to connect the local network to another network, like the Internet. Go to [Section 5.3 on page 36](#) to view the **Status** screen in this mode.

Figure 12 Standard Mode Example

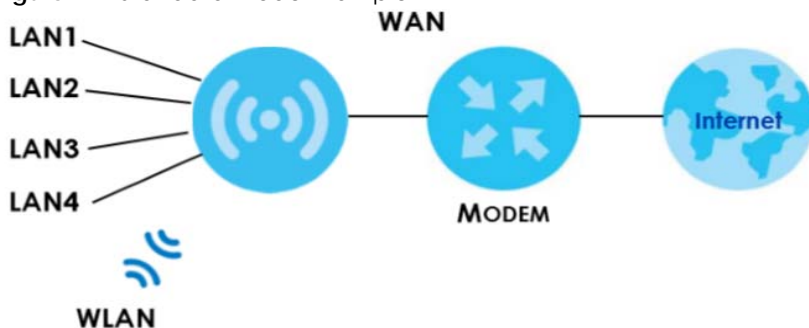

- **Bridge Mode:** Use this mode if you want to extend your network by allowing network devices to connect to the NBG6818 wirelessly. Go to [Section 6.4 on page 41](#) to view the **Status** screen in this mode.

Figure 13 Bridge Mode Example

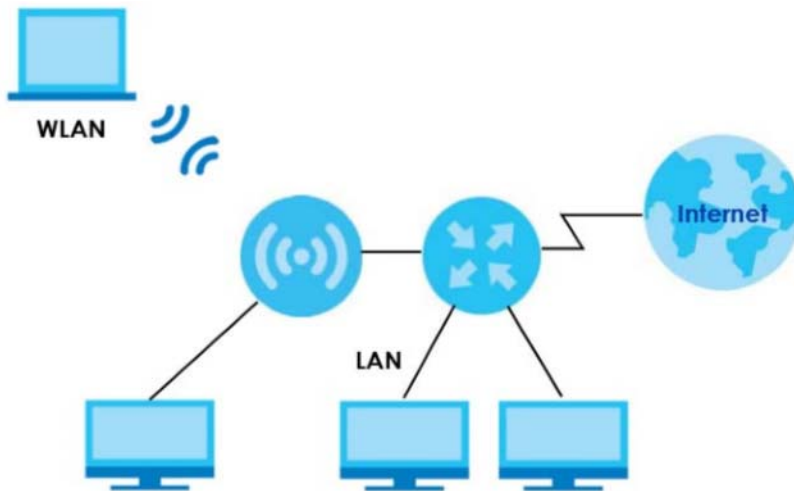

For more information on changing the mode of your NBG6818, refer to [Section 13.7 on page 137](#).

Note: Choose your device mode carefully to avoid having to change it later.

When changing to another mode, the IP address of the NBG6818 changes. The running applications and services of the network devices connected to the NBG6818 may be interrupted.

CHAPTER 5

Standard Mode

5.1 Overview

The NBG6818 is set to standard (router) mode by default. Routers are used to connect the local network to another network (for example, the Internet). In the figure below, the NBG6818 connects the local network (LAN1 ~ LAN4) to the Internet.

Figure 14 NBG6818 in Standard Mode

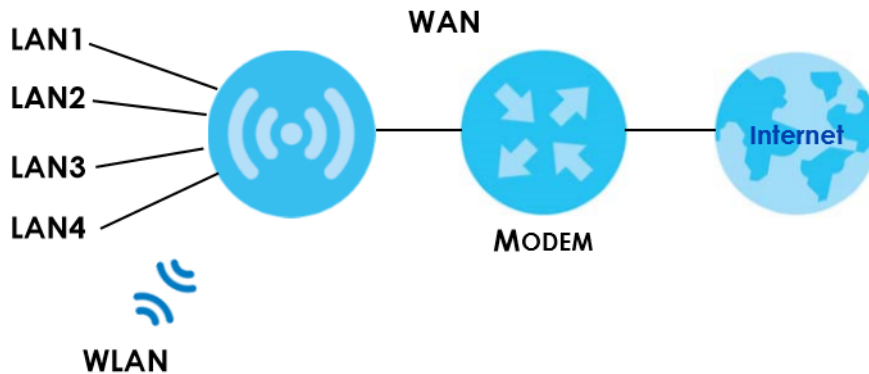

5.2 What You Can Do

- Use the **Status** screen to view read-only information about your NBG6818 ([Section 5.3 on page 36](#)).

5.3 Standard Mode Status Screen

Click **Settings** > **System** > **Status** to open the status screen.

Figure 15 Settings > System > Status (Standard Mode)

System	
Model Name	NBG6818
Firmware Version	V1.00(ABSC.0)b4_fw
System Operation Mode	Standard Mode
Enable IPv4 Firewall	Enable
Enable IPv6 Simple Security	Enable
System Uptime	4 Days 5 Hours 28 Minutes 19 Second
WAN Information	
MAC Address	B8:EC:A3:F5:A7:19
IP Address	
IP Subnet Mask	
Gateway	
IPv6 Address	
LAN Information	
MAC Address	B8:EC:A3:F5:A7:18
IP Address	192.168.123.1
IP Subnet Mask	255.255.255.0
DHCP Server	Enable
IPv6 Address	

The following table describes the labels shown in the **Status** screen.

Table 5 Settings > System > Status (Standard Mode)

LABEL	DESCRIPTION
System	
Model Name	This is the model name of your device.
Firmware Version	This is the firmware version.
System Operation Mode	This is the device mode to which the NBG6818 is set, see Section 13.7 on page 137 for more information.
Enable IPv4 Firewall	This shows if the IPv4 firewall is enabled on the NBG6818.
Enable IPv6 Simple Security	This shows if the IPv6 firewall is enabled on the NB6818.
System Uptime	This is the total time the NBG6818 has been on.
WAN Information	
MAC Address	This shows the WAN Ethernet adapter MAC Address of your device.
IP Address	This shows the WAN port's IP address.

Table 5 Settings > System > Status (Standard Mode) (continued)

LABEL	DESCRIPTION
IP Subnet Mask	This shows the WAN port's subnet mask.
Gateway	This shows the WAN port's gateway IP address.
IPv6 Address	This shows the current IPv6 address of the NBG6818.
LAN Information	
MAC Address	This shows the LAN Ethernet adapter MAC Address of your device.
IP Address	This shows the LAN port's IP address.
IP Subnet Mask	This shows the LAN port's subnet mask.
DHCP Server	This shows the LAN port's DHCP role - Enable or Disable .
IPv6 Address	This shows the current IPv6 address of the NBG6818 in the LAN.

CHAPTER 6

Bridge Mode

6.1 Overview

Use your NBG6818 as a bridge if you already have a router or gateway on your network. In this mode your NBG6818 bridges a wired network (LAN) and wireless LAN (WLAN) in the same subnet. See the figure below for an example.

Figure 16 NBG6818 in Bridge Mode

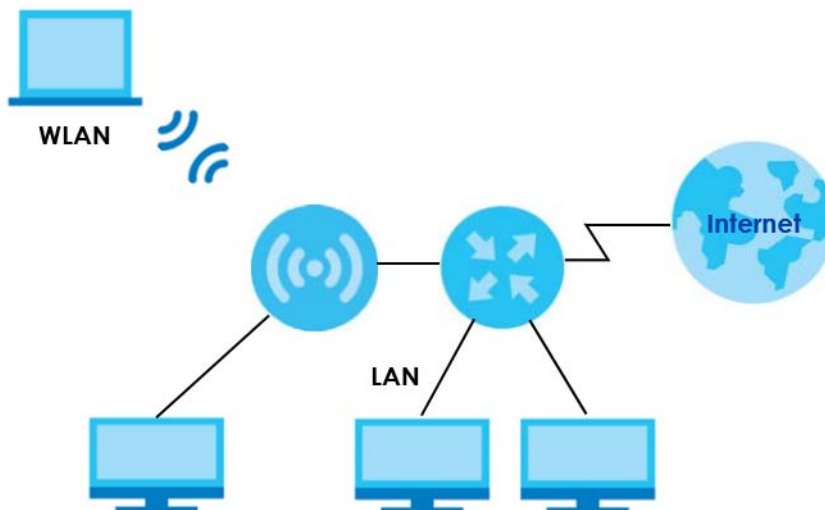

Many screens that are available in **Standard Mode** are not available in **Bridge Mode**, such as port forwarding and firewall. See [Section 3.3 on page 29](#) for more information.

6.2 What You Can Do

- Set up a network with the NBG6818 as a bridge ([Section 6.3 on page 39](#)).
- Use the **Status** screen to view read-only information about your NBG6818 ([Section 6.4 on page 41](#)).

6.3 Setting your NBG6818 to Bridge Mode

- 1 Log into the Web Configurator if you haven't already. See the Quick start Guide for instructions on how to do this.

- 2 To use your NBG6818 as a bridge, go to **Settings > System > Operating Mode** and select **Bridge Mode**.

Figure 17 Changing to Bridge mode

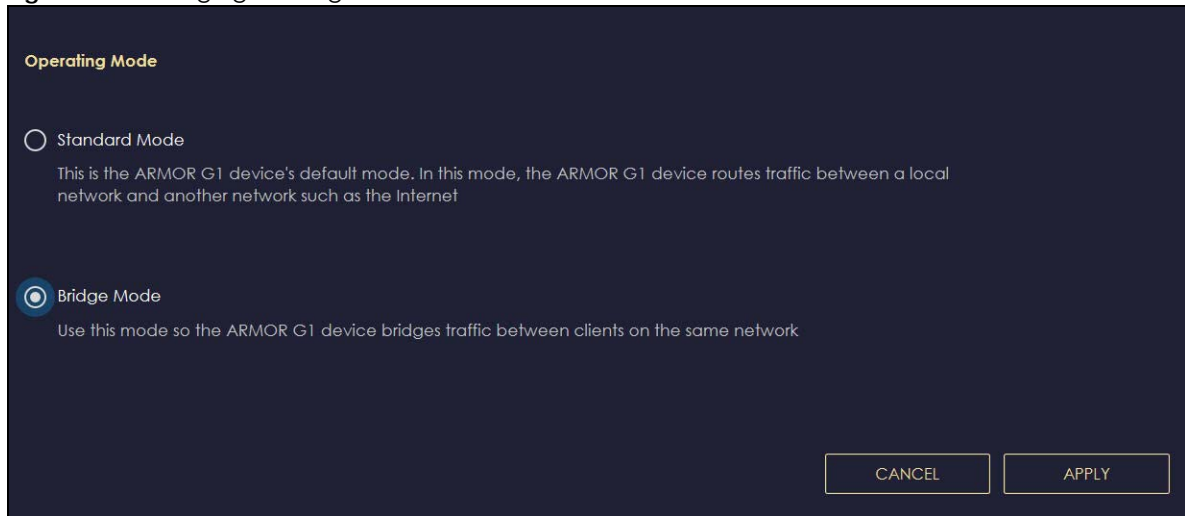

Note: You have to log in to the Web Configurator again when you change modes. As soon as you do, your NBG6818 is already in Bridge mode.

- 3 When you select **Bridge Mode**, the following pop-up message window appears.

Figure 18 Pop up for Bridge mode

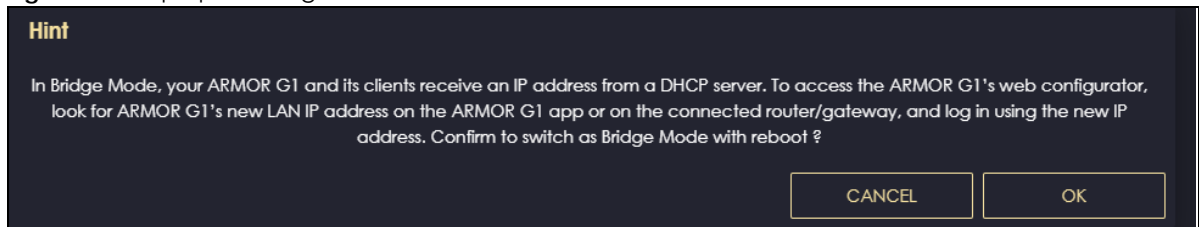

Click **OK**. Then click **Apply**. The Web Configurator refreshes once the change to Bridge mode is successful.

6.3.1 Accessing the Web Configurator in Bridge Mode

Log in to the Web Configurator in Bridge mode, do the following:

- 1 Connect your computer to the LAN port of the NBG6818.
- 2 The default IP address of the NBG6818 in bridge mode is "192.168.123.2". In this case, your computer must have an IP address in the range between "192.168.123.3" and "192.168.123.254".
- 3 Click **Start > Run** on your computer in Windows. Type "cmd" in the dialog box. Enter "ipconfig" to show your computer's IP address. If your computer's IP address is not in the correct range then see [Appendix B on page 153](#) for information on changing your computer's IP address.
- 4 After you've set your computer's IP address, open a web browser such as Internet Explorer and type "192.168.123.2" as the web address in your web browser.

6.4 Bridge Mode Status Screen

Click **Settings** > **System** > **Status** to open the status screen.

Figure 19 Settings > System > Status (Bridge Mode)

The screenshot shows a dark-themed status screen. The 'System' section includes: Model Name (NBG6818), Firmware Version (V1.00[ABSC.1]B1), System Operation Mode (Bridge Mode), Enable IPv4 Firewall (Enable), Enable IPv6 Simple Security (Enable), and System Uptime (0 Days 21 Hours 8 Minutes 50 Second). The 'LAN Information' section includes: MAC Address, IP Address, IP Subnet Mask, DHCP Server (Enable), and IPv6 Address.

System	
Model Name	NBG6818
Firmware Version	V1.00[ABSC.1]B1
System Operation Mode	Bridge Mode
Enable IPv4 Firewall	Enable
Enable IPv6 Simple Security	Enable
System Uptime	0 Days 21 Hours 8 Minutes 50 Second
LAN Information	
MAC Address	
IP Address	
IP Subnet Mask	
DHCP Server	Enable
IPv6 Address	

The following table describes the labels shown in the **Status** screen.

Table 6 Settings > System > Status (Bridge Mode)

LABEL	DESCRIPTION
System	
Model Name	This is the model name of your device.
Firmware Version	This is the firmware version.
System Operation Mode	This is the device mode to which the NBG6818 is set, see Section 13.7 on page 137 for more information.
Enable IPv4 Firewall	This shows if the IPv4 firewall is enabled on the NBG6818.
Enable IPv6 Simple Security	This shows if the IPv6 firewall is enabled on the NB6818.
System Uptime	This is the total time the NBG6818 has been on.
LAN Information	
MAC Address	This shows the LAN Ethernet adapter MAC Address of your device.
IP Address	This shows the LAN port's IP address.
IP Subnet Mask	This shows the LAN port's subnet mask.
DHCP Server	This shows the LAN port's DHCP role - Enable or Disable .
IPv6 Address	This shows the current IPv6 address of the NBG6818 in the LAN.

CHAPTER 7

Tutorials

7.1 Overview

This chapter provides tutorials for setting up your NBG6818.

- [Run a Speed Test](#)
- [Configure the NBG6818's WiFi Networks](#)
- [Enable or Disable a WiFi Network](#)
- [Add Clients to a Profile](#)
- [Set a Profile's WiFi Schedule](#)
- [Pause or Resume Internet Access on a Profile](#)
- [Change Your NBG6818 Operating Mode](#)
- [Configure a Port Forwarding Rule](#)

7.2 Run a Speed Test

With the NBG6818 Web Configurator, you can check the speed of the connection between your NBG6818 and the broadband modem/router.

- 1 Click the **Navigation Panel** icon on the top-left corner () and click **Diagnose** to open the **Advanced Speed Test** screen. Use this screen to view all the available connections in your NBG6818 System.

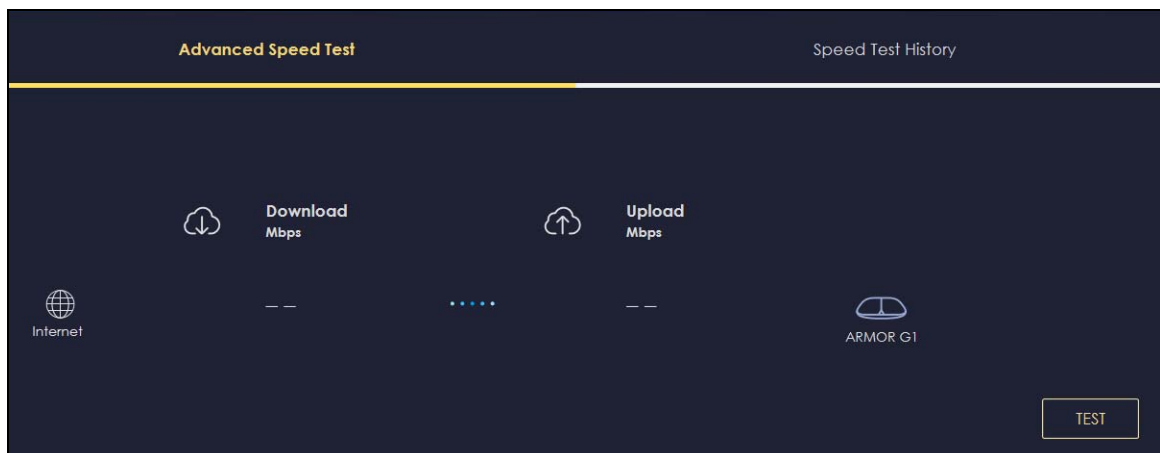

- 2 Click **TEST** to perform a speed test. This shows data rates for both upstream and downstream traffic. Click **TEST AGAIN** to update the information in this screen.

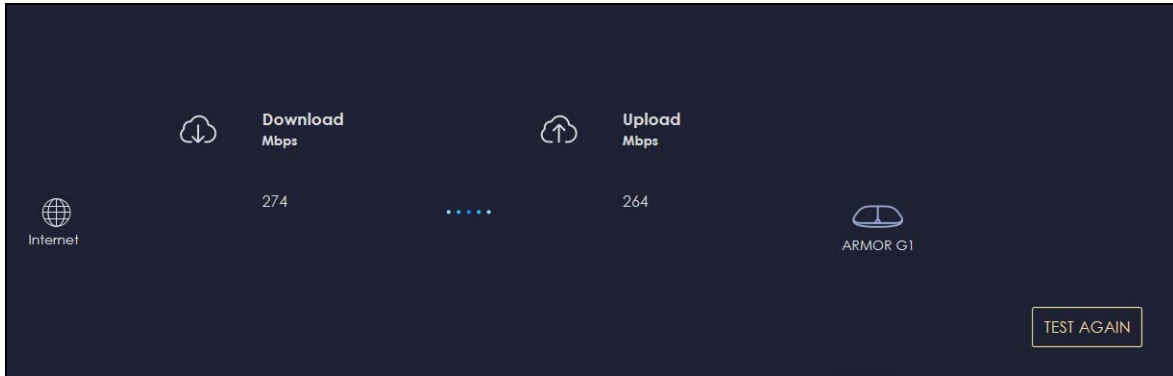

- 3 Click the **Speed Test History** tab to view a summary of the tests made. Click **Clear** to delete all records.

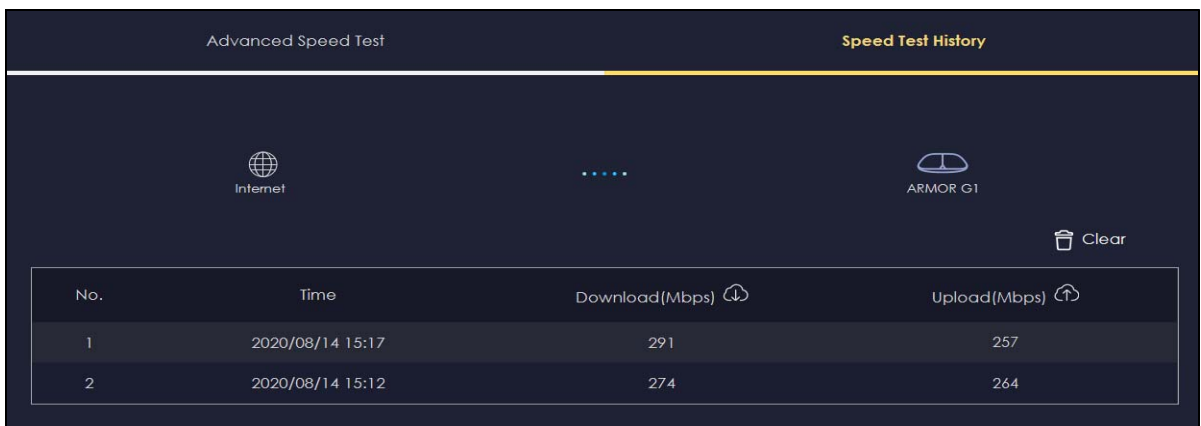

7.3 Configure the NBG6818's WiFi Networks

In the NBG6818 you can configure independent wireless networks with different privileges. Clients can associate only with the network for which they have security settings (SSID and password). The following table describes the different NBG6818's profile networks and their privileges.

Table 7 WiFi Network Privileges

WIFI NETWORK	INTERNET ACCESS	2.4G / 5G WIFI NETWORK	ACCESS TO WEB CONFIGURATOR	ACCESS TO WIRED LAN
Main WiFi	Yes	2.4G and 5G	Yes	Yes
Guest WiFi	Yes	2.4G and 5G	No	No

Note: A user can only configure the WiFi networks' security settings if they are connected to the **Main WiFi** network.

- 1 Click the **Navigation Panel** icon on the top-left corner () and click **Settings** to open the **WiFi** screen. Use each tab in the **WiFi** menu to configure each of the WiFi networks' security settings.



- 2 Select **Enable** to activate a WiFi Network. Enter the **2.4G/5G Name** and **Password** clients use to connect to the WiFi network. You can configure two different WiFi Names for the **Main WiFi** 2.4G and 5G networks. Select **Keep 2.4G & 5G name the same**, so they both use the same WiFi Name. Click **Apply** to save your changes.

Main WiFi

Enable Main WiFi Enable Disable

Name (SSID) NBG6818_TW

Keep 2.4G & 5G name the same

Security Mode WPA2-PSK WPA3-PSK WPA3-PSK Mix

Password ••••••••

Region US

2.4G Bandwidth 40

2.4G Channel Auto Channel : 11

5G Bandwidth 80

5G Channel Auto Channel : 36

CANCEL APPLY

7.4 Enable or Disable a WiFi Network

After the NBG6818 is set up, you can use separate WiFi networks for your clients. The WiFi settings will be applied to all clients in the same network.

Note: This is not available if you are using bridge mode.

- 1 Click the **Navigation Panel** icon on the top-left corner () and click **Settings** to open the **WiFi** screen.



- 2 Enable guest WiFi and enter the **WiFi Name (SSID)** and **WiFi Password**. Click **Apply** to save your changes.





A screenshot of the 'Guest WiFi' configuration page. The page has a dark theme. At the top, it says 'Guest WiFi'. Below that, there are four sections: 'Enable Guest WiFi' with radio buttons for 'Enable' and 'Disable' (the latter is selected); 'Name(SSID)' with a text input field containing 'NBG6818_TW.guest'; 'Security Mode' with radio buttons for 'WPA2-PSK' (selected), 'WPA3-PSK', and 'WPA3-PSK Mix'; and 'Password' with a masked text input field. At the bottom right, there are two buttons: 'CANCEL' and 'APPLY'.

7.5 Add Clients to a Profile

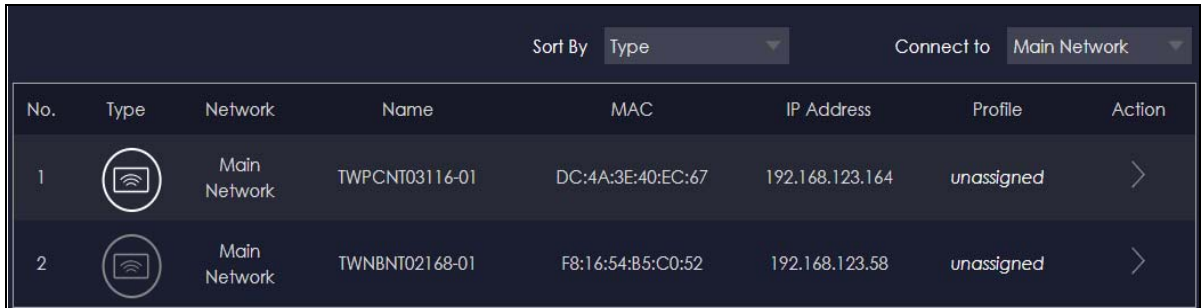
Profiling clients allows you to easily block/allow Internet access or set a schedule for all client devices in the same profile.

- 1 Click the **Navigation Panel** icon on the top-left corner () and click **Parental Control** to open the **Device** screen. Use the **Device** screen to view all the clients in your NBG6818.



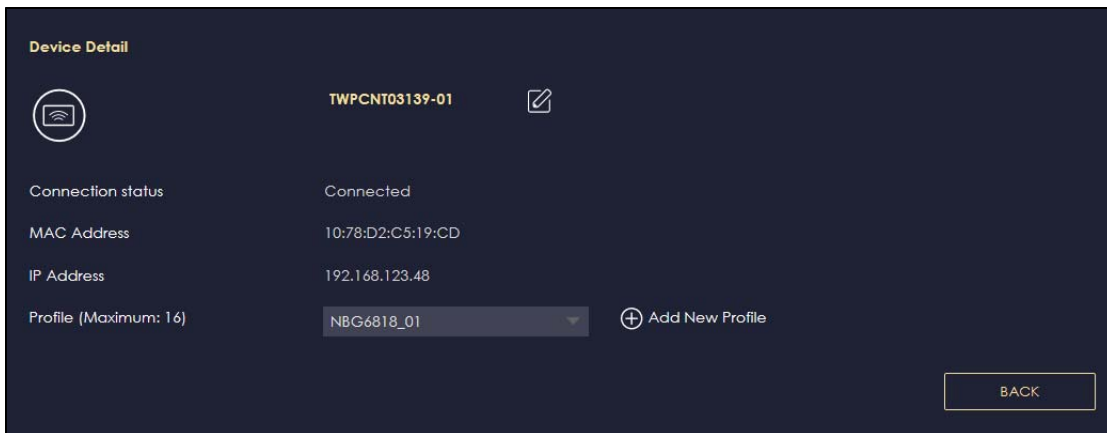

No.	Type	Network	Name	MAC	IP Address	Profile	Action
1		Main Network	TWPCNT03116-01	DC:4A:3E:40:EC:67	192.168.123.164	unassigned	
2		Main Network	TWNBNT02168-01	F8:16:54:B5:C0:52	192.168.123.58	unassigned	

- 2 Click the icon under **Action** () to view the user information. In **Device Detail**, select a predefined profile and click **Apply**.



Device Detail

 **TWPCNT03139-01** 

Connection status: Connected

MAC Address: 10:78:D2:C5:19:CD

IP Address: 192.168.123.48

Profile (Maximum: 16):  Add New Profile

7.6 Set a Profile's WiFi Schedule

When you create or edit a profile, you can schedule the NBG6818 to automatically disable or enable WiFi access during a certain period of time for clients in that profile.

Note: This is not available if you are using bridge mode.

- 1 Click the **Navigation Panel** icon on the top-left corner () and click **Parental Control**, and click the **Profile** tab. Use the **Profile** screen to display the profiles created in the NBG6818.

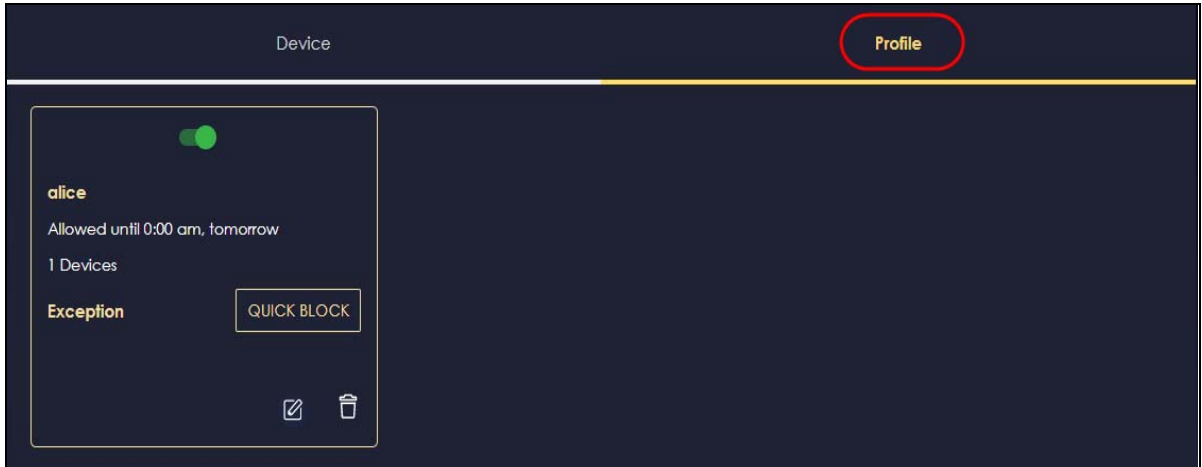

- 2 Click **Enable** to activate this profile's Internet schedule. Click the **Edit** icon () to modify a profile's Internet schedule.

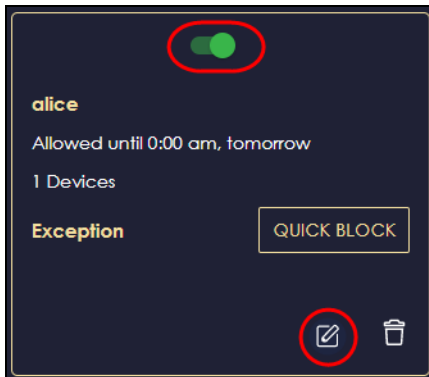

- 3 Click the start time cell and drag down to the end time to set up your schedule.

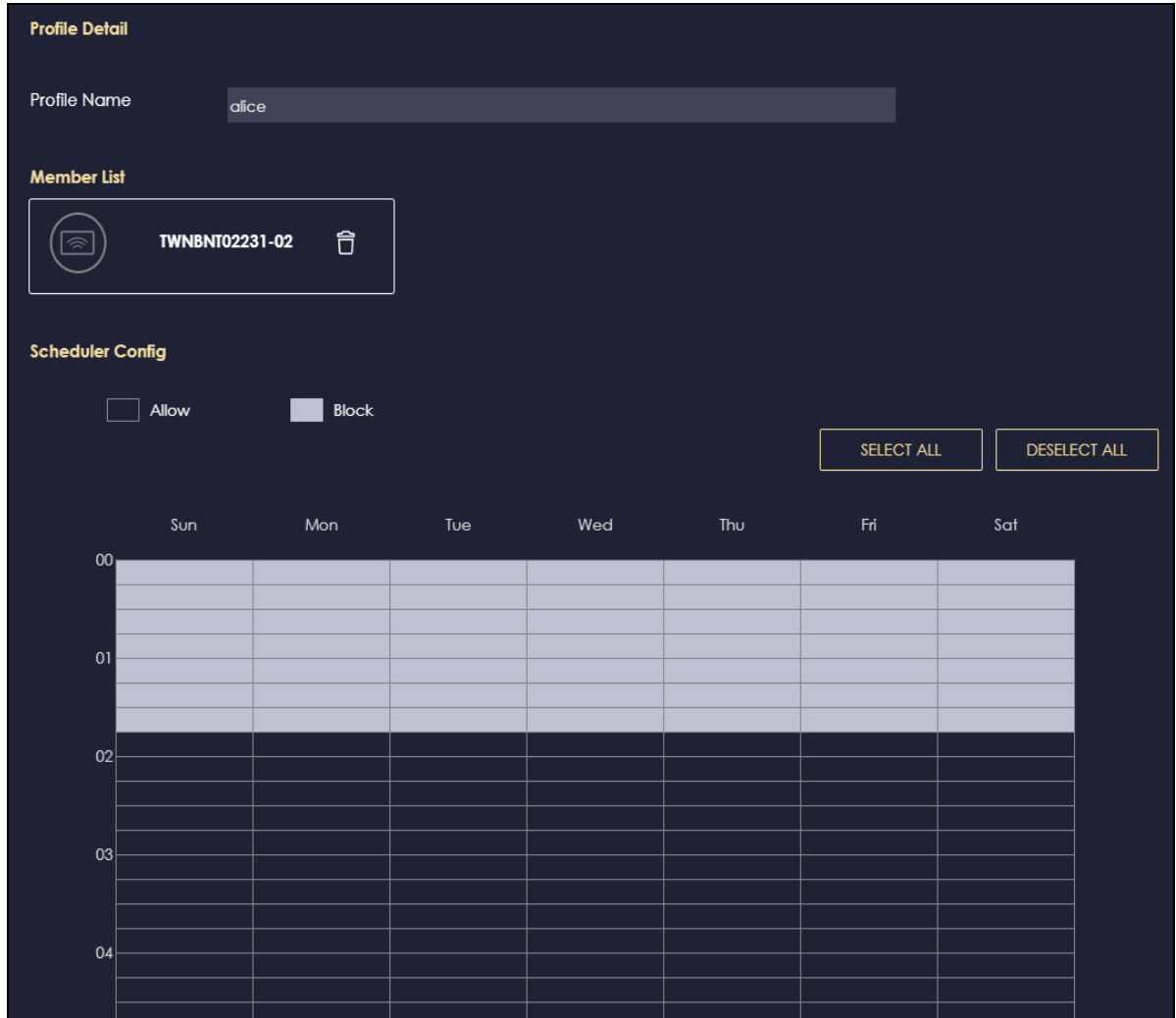

7.7 Pause or Resume Internet Access on a Profile

You may want to manually block a profile of client devices from accessing the Internet immediately and resume it later.

Note: This is not available if you are using bridge mode.

- 1 Click the **Navigation Panel** icon on the top-left corner () .Select **Parental Control**, and click the **Profile** tab. Use the **Profile** screen to display the profiles created in the NBG6818.

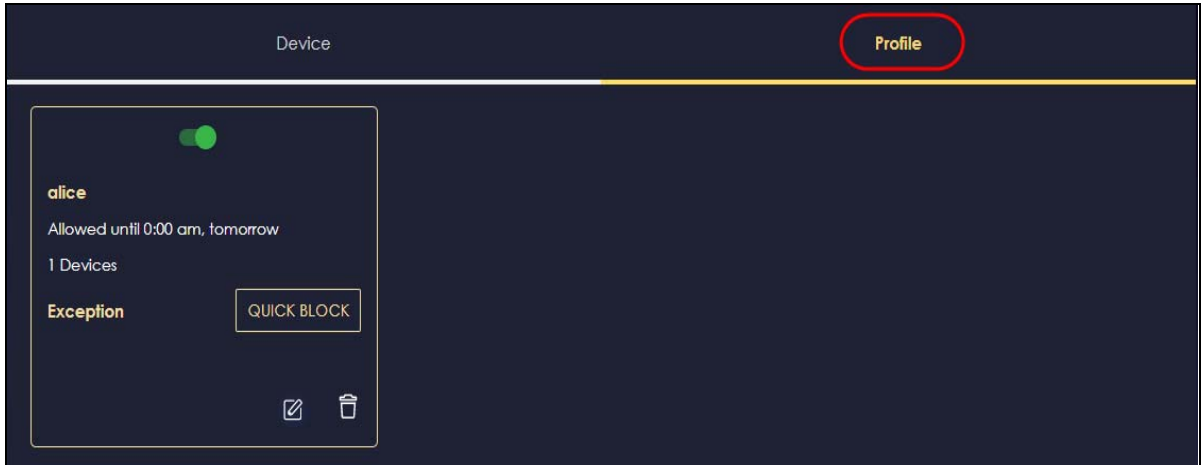

- 2 Click a profile's **Resume** button to resume network access at once, or click the **Quick Block** button to pause Internet access for that specific profile.

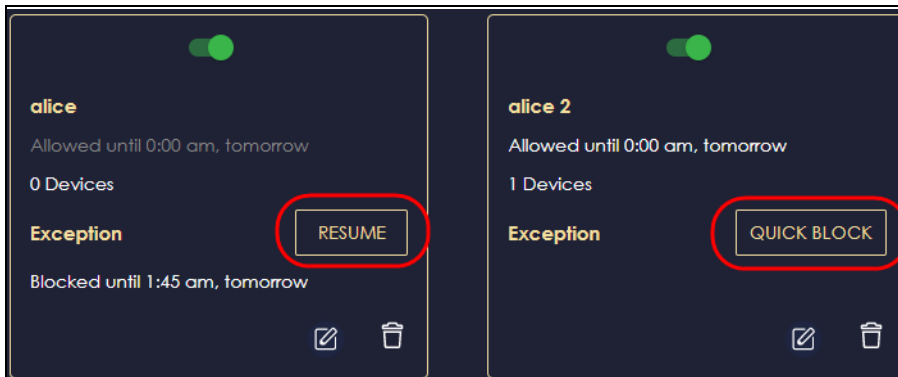

7.8 Turn on or off the NBG6818's LED (Light)

- 1 In the **Overview** screen, find the **LED** field and drag the button of the slider to the left.

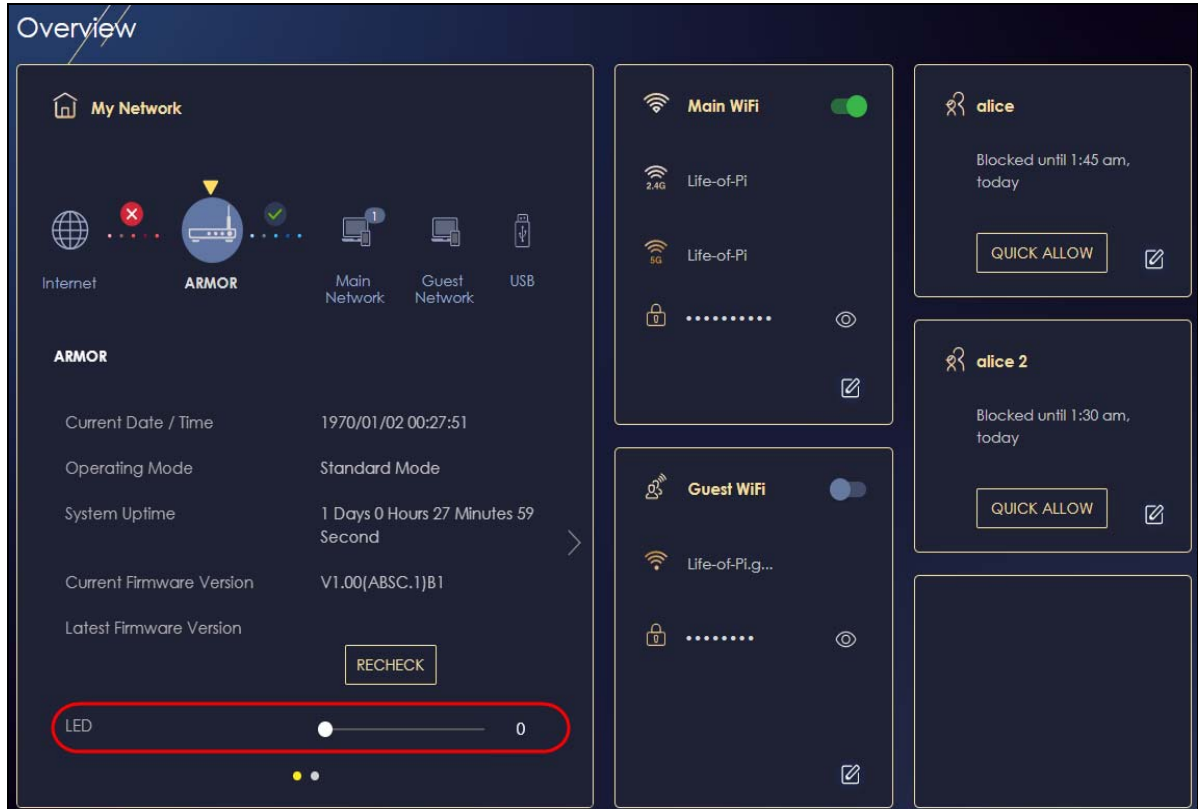

7.9 Change Your NBG6818 Operating Mode

The operating mode refers to how the NBG6818 is being used in the network. The NBG6818 has two operating modes:

- **Standard:** This is the NBG6818's default mode. In this mode, the NBG6818 routes traffic between a local network and another network such as the Internet.
- **Bridge:** Use this mode so the NBG6818 bridges traffic between clients on the same network.

Note: Features such as parental Control, UPnP, Port Forwarding are not available in Bridge mode.

- 1 Click the **Navigation Panel** icon on the top-left corner (☰). From the **Settings** drop-down list, click **System**, then click the **Operating Mode** tab. Select the operating mode and select **APPLY** to save your changes. Changing the NBG6818's operating mode may take up to two minutes.

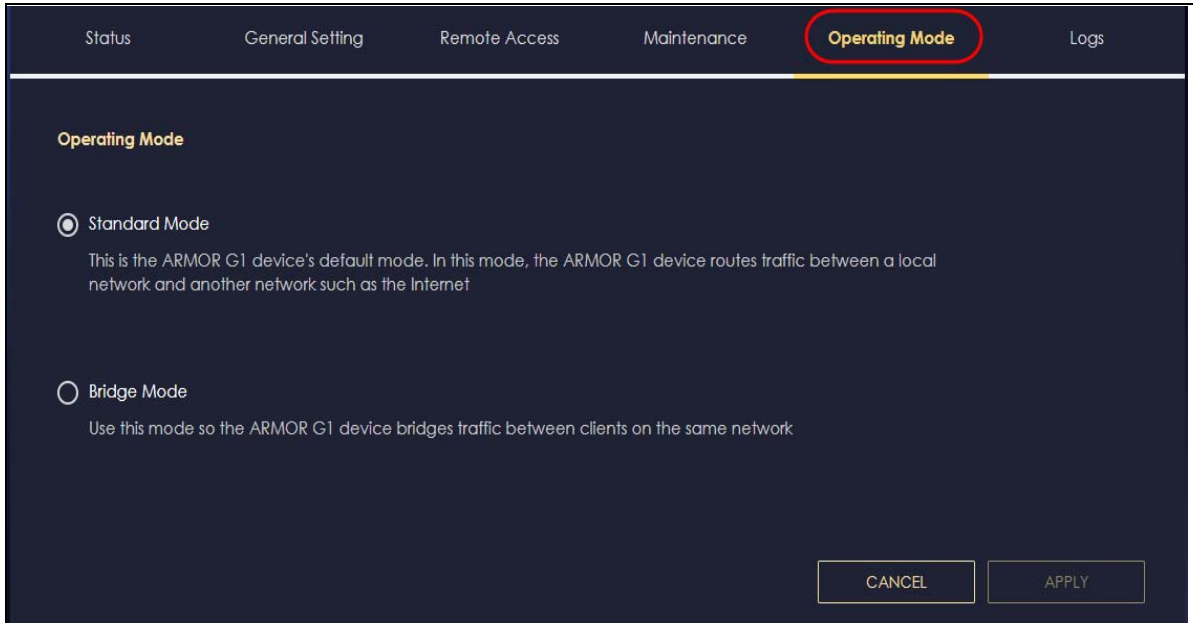

7.10 Configure a Port Forwarding Rule

If you want to forward incoming packets to a specific or appropriate IP address in the private network using ports, set a port forwarding rule.

Note: This is not available if you are using bridge mode.

- 1 Click the **Navigation Panel** icon on the top-left corner (). From the **Settings** drop-down list, select **Internet**, and click the **NAT & Port Forwarding** tab.

Internet Connection **NAT & Port Forwarding** Passthrough Port Trigger Dynamic DNS UPnP

NAT & Port Forwarding

Network Address Translation (NAT) Enable Disable

Server Setup Default Server - 192.168.123.1
 Change to Server
 TWNBNT02231-02

Port Forwarding Rule (The maximum number of rules is 32.)

Enable Port Forwarding Enable Disable

[+ Add Rule](#)

No.	Name	Protocol	External Port	Server IP Address	Internal Port	Actions
-----	------	----------	---------------	-------------------	---------------	---------

CANCEL APPLY

- 2 Select **Enable** in the **Enable Port Forwarding** field.

Port Forwarding Rule (The maximum number of rules is 32.)

Enable Port Forwarding Enable Disable

- 3 Click **Add Rule** to create a port forwarding rule. Add a service name, a port number or a range of ports to define the service to be forwarded, specify the transport layer protocol used for the service, and the IP address of a device on your local network that will receive the packets from the port(s).

Add Port Forwarding Rule

Service Name	User-Define
Protocol	TCP/UDP
External Port	Ex: 10 or 10-20
Device List	TWNBNT02231-02 (192.168.123.143)
Internal Port	Ex: 1~65535

PART II

Technical Reference

CHAPTER 8

Applications

8.1 Overview

This chapter shows you how to configure parental control, OpenVPN, USB media sharing and file sharing.

8.1.1 What You Can Do

- Use the **Parental Control** screens to enable parental control, configure the parental control rules and schedules, and send e-mail notifications. ([Section 8.2 on page 57](#)).
- Use the **OpenVPN Server** screen to create or configure your NBG6818 when it functions as an OpenVPN Server ([Section 8.3.1 on page 61](#)).
- Use the **OpenVPN Client** screen to add an OpenVPN Server Account you want your NBG6818 to connect to ([Section 8.3.3 on page 65](#)).
- Use the **USB Application** screen to allow file sharing or to set up your NBG6818 to act as a media server ([Section 8.4 on page 67](#)).

8.1.2 What You Need To Know

The following terms and concepts may help as you read through this chapter.

DLNA

The Digital Living Network Alliance (DLNA) is a group of personal computer and electronics companies that works to make products compatible in a home network. DLNA clients play files stored on DLNA servers. The NBG6818 can function as a DLNA-compliant media server and stream files to DLNA-compliant media clients without any configuration.

Workgroup name

This is the name given to a set of computers that are connected on a network and share resources such as a printer or files. Windows automatically assigns the workgroup name when you set up a network.

File Systems

A file system is a way of storing and organizing files on your hard drive and storage device. Often different operating systems such as Windows or Linux have different file systems. The file-sharing feature on your NBG6818 supports New Technology File System (NTFS), File Allocation Table (FAT) and FAT32 file systems.

The NBG6818 uses Common Internet File System (CIFS) protocol for its file sharing functions. CIFS compatible computers can access the USB file storage devices connected to the NBG6818. CIFS

protocol is supported on Microsoft Windows, Linux Samba and other operating systems (refer to your systems specifications for CIFS compatibility).

Samba

SMB is a client-server protocol used by Microsoft Windows systems for sharing files, printers, and so on.

Samba is a free SMB server that runs on most Unix and Unix-like systems. It provides an implementation of an SMB client and server for use with non-Microsoft operating systems.

File Transfer Protocol

This is a method of transferring data from one computer to another over a network such as the Internet.

VPN

A virtual private network (VPN) provides secure communications between sites without the expense of leased site-to-site lines. A secure VPN is a combination of tunneling, encryption, authentication, access control and auditing. It is used to transport traffic over the Internet or any insecure network that uses TCP/IP for communication.

8.1.3 Before You Begin

Make sure the NBG6818 is connected to your network and turned on.

- 1 Connect the USB device to one of the NBG6818's USB ports.
- 2 The NBG6818 detects the USB device and makes its contents available for browsing. If you are connecting a USB hard drive that comes with an external power supply, make sure it is connected to an appropriate power source that is on.

Note: If your USB device cannot be detected by the NBG6818, see the troubleshooting for suggestions.

8.2 Parental Control

Parental Control allows you to block specific URLs. You can also define time periods and days during which the NBG6818 performs parental control on a specific user.

Note: This is not available if you are using bridge mode.

8.2.1 Device Screen

Use this screen to enable parental control, view the parental control rules and schedules.

Click **Parental Control > Device** to show the following screen.

Figure 20 Parental Control > Device

No.	Type	Network	Name	MAC	IP Address	Profile	Action
1		Main Network	TWPCNT03116-01	DC:4A:3E:40:EC:67	192.168.123.164	unassigned	
2		Main Network	TWNBNT02168-01	F8:16:54:85:C0:52	192.168.123.58	unassigned	

The following table describes the fields in this screen.

Table 8 Parental Control

LABEL	DESCRIPTION
Sort By	Choose to sort the order of your devices by Type or Name .
Connect to	Choose whether you want to show devices that are connected to Main Network or devices that are connected Guest Network . Choose All if you want to show all devices.
No.	This shows the index number of the rule.
Type	The shows the type of device to which this rule applies.
Network	This shows the type of network the devices are connected to.
Name	This shows the name of the user to which this rule applies.
MAC	This field shows the MAC address of the device with the name in the Name field. Every Ethernet device has a unique MAC (Media Access Control) address which uniquely identifies a device. The MAC address is assigned at the factory and consists of six pairs of hexadecimal characters, for example, 00:A0:C5:00:00:02.
IP Address	This field displays the IP address relative to the No. field listed above.
Profile	This shows the name of the rule that is applied to the device. If no rule exists, unassigned is showed in this field.
Action	Click the Action icon () to configure a rule for the device.

8.2.1.1 Edit Device Detail Screen

Use this screen to configure basic settings for the device. Click the **Action** icon () , and then the **Edit** icon () to show the following screen.

Figure 21 Edit Device Detail

Table 9 Edit Device Detail

LABEL	DESCRIPTION
Device Name	Enter a name for the device to which this rule applies.
Type	Choose the type of device to which this rule applies.
Apply	Click Apply to save your settings back to the NBG6818.
Cancel	Click Cancel to exist the screen without saving.

8.2.1.2 Add New Profile Screen

Use this screen to configure a restricted access schedule. Click the **Action** icon (), then **Add New Profile** to show the following screen.

Figure 22 Add New Profile

The screenshot shows a dark-themed interface for adding a new profile. At the top, there's a title 'Add New Profile' and a text input field for 'Profile Name'. Below that is the 'Scheduler Config' section, which includes two radio buttons: 'Allow' (unselected) and 'Block' (selected). To the right of these are two buttons: 'SELECT ALL' and 'DESELECT ALL'. The main part of the screen is a grid with columns for days of the week (Sun, Mon, Tue, Wed, Thu, Fri, Sat) and rows for hours (00 to 07). The grid is currently empty, indicating no scheduling has been set.

The following table describes the fields in this screen.

Table 10 Add New Profile

LABEL	DESCRIPTION
Profile Name	Enter a name for this rule.
Select All	Click Select All then deselect the blocks you don't want or click on blocks separately to specify days and times to turn the Wireless LAN on or off.
Deselect All	Click Deselect All to remove all the wireless LAN scheduling.
Apply	Click Apply to save your changes back to the NBG6818.
Back	Click Back to exist the screen without saving.

8.2.1.3 Profile Screen



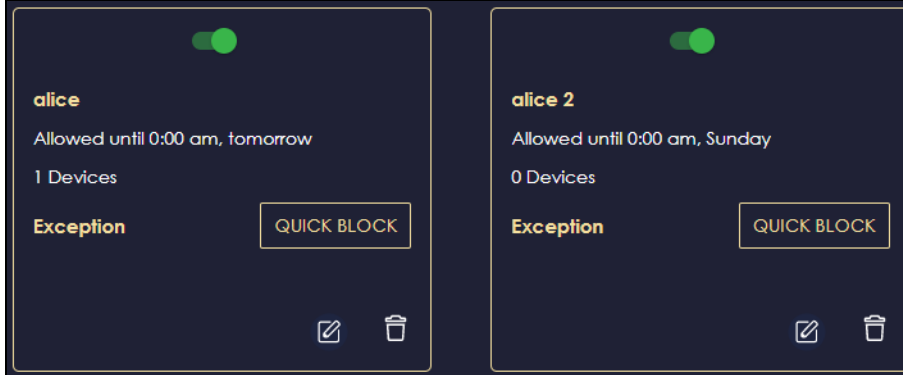

Use this screen to edit or delete an existing rule. Click **Parental Control > Profile** to show the following screen.

Figure 23 Parental Control > Profile



The following table describes the fields in this screen.

Table 11 Parental Control > Profile

LABEL	DESCRIPTION
Enable/Disable 	Set the switch to the right () to enable an existing rule. Otherwise, set the switch to the left ()
Quick Block	Click Quick Block to activate the profile.
Edit 	Click on the Edit icon to edit an existing rule.
Delete 	Click on the Delete icon to delete an existing rule.

8.3 OpenVPN Server/Client

OpenVPN is a VPN protocol which is open source and free of charge. It can be used to create a virtual private network or to interconnect local networks.

It uses OpenSSL encryption library and SSLv3/TLSv1 protocols. This provides high security and anonymity for all transmitted data.

It also provides faster connection speeds than other VPN protocols.

Note: We do not recommended activating OpenVPN Server and OpenVPN Client at the same time on your NBG6818.

8.3.1 OpenVPN Server Screen

Use this screen to create an OpenVPN server account. Click the **Navigation Panel** icon on the top-left corner () .Select **OpenVPN Server**, and click the **OpenVPN Server** tab.

Figure 24 Example of NBG6818 Acting As VPN Server

Note: You have to enable DDNS in **Settings > Internet > Dynamic DNS** screen before you can create an OpenVPN account. See [Section 9.8 on page 95](#) for more information on Dynamic DNS.

Figure 25 OpenVPN Server

OpenVPN Server

Dynamic DNS Enable Disable

Host Name

Configuration

Status Enable Disable

Protocol TCP UDP

Server Port

VPN Subnet / Netmask /

Advertise DNS to Clients Enable Disable

Key Setting

The following table describes the fields in this screen.

Table 12 OpenVPN Server

LABEL	DESCRIPTION
OpenVPN Server	
Dynamic DNS	This field shows the status of your Dynamic DNS. Make sure it shows Enable before you create an OpenVPN account.
Host Name	This field shows the Host Name of your Dynamic DNS account.
Configuration	
Status	Select Enable to activate your OpenVPN Server account.
Protocol	Select the protocol you want to apply to your OpenVPN Server account.

Table 12 OpenVPN Server

LABEL	DESCRIPTION
Server Port	The default server port number is 1194. You can change it if needed. However, clients connected to this OpenVPN Server account will have to use the same port number in order to access the server account.
VPN Subnet/ Netmask	The fields define the network from which OpenVPN clients can connect to the NBG6818 OpenVPN server. Enter an IPv4 address and subnet mask.
Advertise DNS to Clients	Select Enable if you want the NBG6818 to broadcast its OpenVPN server to OpenVPN clients in its VPN network defined previously.
Key Setting	Click the Change Key button if you want to change the key your clients use to access to your OpenVPN Server account. You do not need to click Change Key the first time to configure this screen. Periodically changing the key is recommended, but you must export the new .ovpn configuration file and send it to all OpenVPN clients so that they can they use the new key.
Export Config	Click Export Config to export your configuration to an .ovpn file that OpenVPN clients need to connect to the NBG6818 OpenVPN server.
Apply	Click Apply to save your changes back to the NBG6818.
Cancel	Click Cancel to begin configuring this screen afresh.

8.3.2 OpenVPN Account Screen

Use the **OpenVPN Account List** screen to view the basic information of the NBG6818 OpenVPN server.

Use the **OpenVPN Account Status** screen to view the basic information of clients that are connected to the NBG6818 OpenVPN server

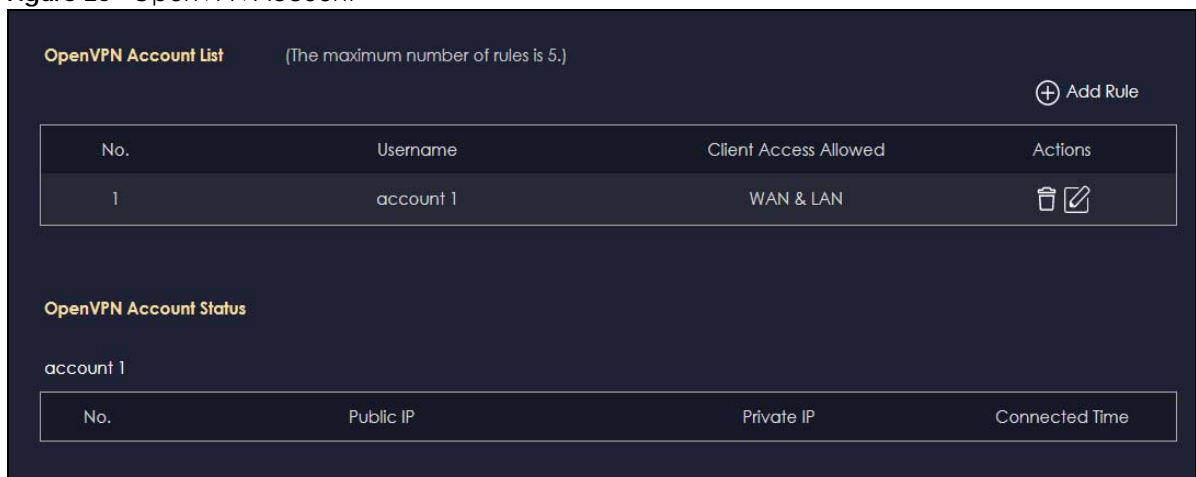

Note: At the time of writing, up to 16 OpenVPN clients can connect to the NBG6818 OpenVPN server at the same time.

Figure 26 OpenVPN Account



The following table describes the fields in this screen.

Table 13 OpenVPN Account

LABEL	DESCRIPTION
OpenVPN Account List	
No.	This is the rule index number.
Username	This field displays a name to identify this rule.
Password	This field displays a combination of characters and numbers clients need to connect to an account.
Client Access Allowed	This field displays the interface(s) through which the clients are allowed to connect to an account.
Actions	<p>Click the icons under Actions to delete or edit an existing OpenVPN account settings.</p> <p>Click  to delete an existing OpenVPN account.</p> <p>Click  to edit an existing OpenVPN account.</p>
OpenVPN Account Status	
No.	This is the number used to identify a client.
Public IP	This field displays the public IP of a client.
Private IP	This field displays the private IP of a client.
Connected Time	This field displays how long a client is connected.

8.3.2.1 OpenVPN Account List-Add Rule Screen

Use this screen to configure your OpenVPN account settings.

Figure 27 OpenVPN Account List-Add Rule

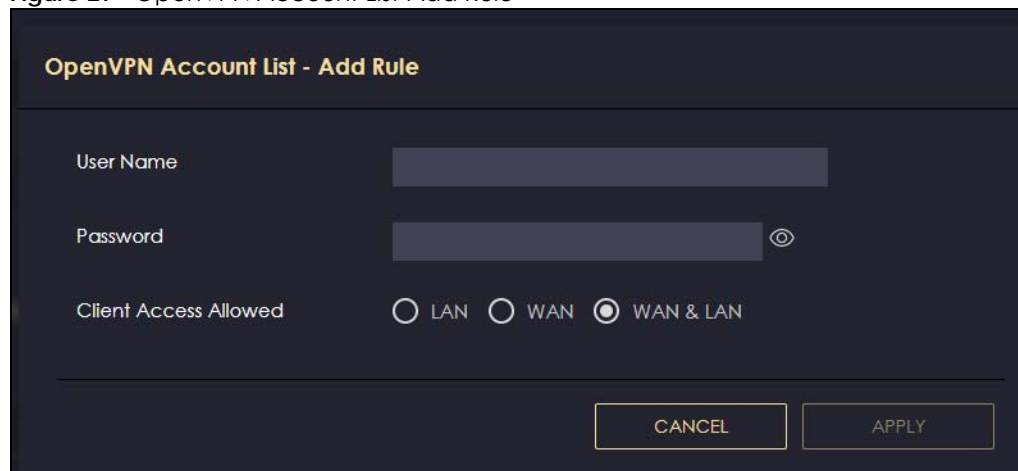

The following table describes the fields in this screen.

Table 14 OpenVPN Account List-Add Rule

LABEL	DESCRIPTION
User Name	Enter 1-32 single-byte printable ASCII characters, but <>^\$& are not allowed.
Password	Enter 1-32 single-byte printable ASCII characters, but <>^\$& are not allowed.
Client Access Allowed	Select the interface(s) through which the clients are allowed to connect to your account.

Table 14 OpenVPN Account List-Add Rule

LABEL	DESCRIPTION
Apply	Click Apply to save your changes back to the NBG6818.
Cancel	Click Cancel to exist this screen without saving.

8.3.3 OpenVPN Client Screen

Use the **OpenVPN Server List** in this screen to view the basic information of the OpenVPN Server accounts that you are connected to when the NBG6818 functions as an OpenVPN client.

Figure 28 Example of NBG6818 Acting As VPN Client

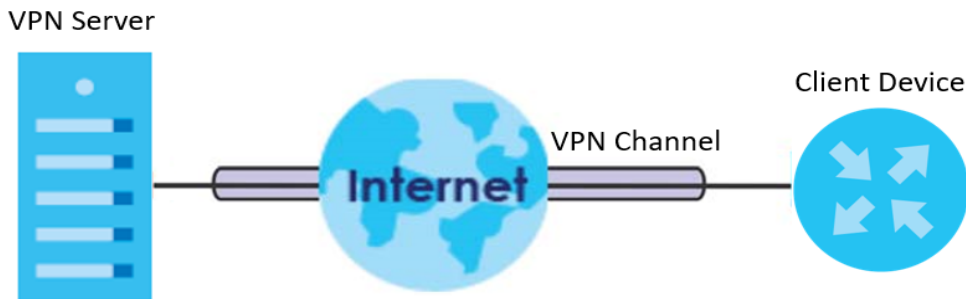

Note: You can only connect to one server at a time.

Figure 29 OpenVPN Client

The screenshot shows the 'OpenVPN Server List' screen. At the top, it says '(The maximum number of rules is 5.)' and has an 'Add Rule' button. Below is a table with the following data:



No.	Description	Enable VPN on	Connected IP	Active	Actions
1	alice	LAN1, LAN2, LAN3, LAN4, WIFI 2.4G, WIFI 5G		<input checked="" type="checkbox"/>	

The following table describes the fields in this screen.

Table 15 OpenVPN Client

LABEL	DESCRIPTION
No.	This is the rule index number.
Description	This field displays a name to identify this rule.
Enable VPN on	This field displays the interface(s) through which your NBG6818 are allowed to connect to an OpenVPN Server account.
Connected IP	This field displays the IP address of the OpenVPN Server account your NBG6818 is connected to.

Table 15 OpenVPN Client

LABEL	DESCRIPTION
Active	Slide the switch to the right () to activate your connection to an OpenVPN Server account.
Actions	Click the icons under Actions to delete or edit an existing OpenVPN Server account settings. Click  to delete an existing OpenVPN Server account. Click  to edit an existing OpenVPN Server account.

8.3.3.1 OpenVPN Server List-Add Rule Screen

Use this screen to add an OpenVPN Server Account that you want your NBG6818 to connect to.

Figure 30 OpenVPN Server List-Add Rule

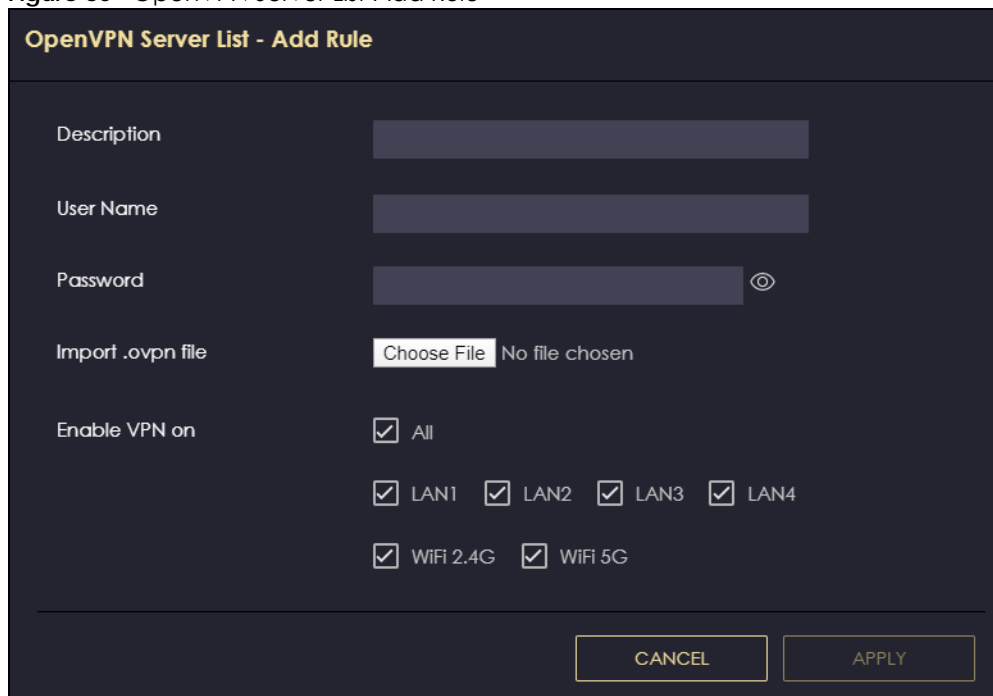

The following table describes the fields in this screen.

Table 16 OpenVPN Server List-Add Rule

LABEL	DESCRIPTION
Description	Enter 1-32 single-byte printable ASCII characters, but <>^\$& are not allowed.
User Name	Enter the User Name of the OpenVPN Server account you want to connect to.
Password	Enter the Password of the OpenVPN Server account you want to connect to.
Import .ovpn file	Import an .ovpn file that you get from the OpenVPN Server that you want to connect to. Note: Do not import the .ovpn file you get from your NBG6818's OpenVPN Server.
Enable VPN on	Select the interface(s) that are allowed by the OpenVPN Server account you want to connect to.

Table 16 OpenVPN Server List-Add Rule

LABEL	DESCRIPTION
Apply	Click Apply to save your changes back to the NBG6818.
Cancel	Click Cancel to exist this screen without saving.

8.4 USB Application

8.4.1 SAMBA Server Screen

Use this screen to set up file-sharing via the NBG6818 using Windows Explorer or the workgroup name. You can also configure the workgroup name and create file-sharing user accounts.

Click **USB Application > SAMBA** to show the following screen.



Figure 31 USB Application > SAMBA

The following table describes the labels in this screen.

Table 17 USB Application > SAMBA

LABEL	DESCRIPTION
SAMBA Setup	
Enable SAMBA	Select this to enable file sharing through the NBG6818 using Windows Explorer or by browsing to your work group.
Name	Specify the name to identify the NBG6818 in a work group.

Table 17 USB Application > SAMBA (continued)

LABEL	DESCRIPTION
Work Group	<p>You can add the NBG6818 to an existing or a new workgroup on your network. Enter the name of the workgroup which your NBG6818 automatically joins. You can set the NBG6818's workgroup name to be exactly the same as the workgroup name to which your computer belongs to.</p> <p>Note: The NBG6818 will not be able to join the workgroup if your local area network has restrictions set up that do not allow devices to join a workgroup. In this case, contact your network administrator.</p>
Description	Enter the description of the NBG6818 in a work group.
Require username and password	Select Yes to need a user account for access to the connected USB stick from any computer. Otherwise, select No .
User Accounts	Before you can share files you need a user account. Configure the following fields to set up a file-sharing account.
No.	This is the index number of the user account.
Status	This field displays whether a user account is activated or not.
User Name	This field displays the user name that will be allowed to access the shared files.
USB	This field displays the user's access rights to the USB storage device which is connected to the NBG6818's USB port.
Actions	<p>Click the icons under Actions to delete or edit a port forwarding rule.</p> <p>Click  to delete an existing trigger port settings.</p> <p>Click  to edit an existing trigger port settings.</p>
Apply	Click Apply to save your changes back to the NBG6818.
Cancel	Click Cancel to begin configuring this screen afresh.

8.4.1.1 Add SAMBA Account Screen

Use this screen to configure settings for a SAMBA account.

Click **USB Application > SAMBA > Add Rule** to show the following screen.

Figure 32 USB Application > SAMBA > Add Rule

The following table describes the labels in this screen.

Table 18 USB Application > SAMBA > Add Rule

LABEL	DESCRIPTION
Status	Select Enable to enable the account. Select Disable to disable the account.
User Name	Enter a user name that will be allowed to access the shared files. You can enter up to 20 characters. Only letters and numbers allowed.
Password	Enter the password used to access the shared files. You can enter up to 20 characters. Only letters and numbers are allowed. The password is case sensitive.
USB	Specify the user's access rights to the USB storage device which is connected to the NBG6818's USB port. Read & Write - The user has read and write rights, meaning that the user can create and edit the files on the connected USB device. Read - The user has read rights only and can not create or edit the files on the connected USB device. None - The user cannot access the files on the USB device(s) connected to the USB port.
Apply	Click Apply to save your changes back to the NBG6818.
Cancel	Click Cancel to exist the screen without saving.

8.4.2 FTP Server Screen



Use this screen to set up file sharing via the NBG6818 using FTP and create user accounts.

Click **USB Application > FTP** to show the following screen.

Figure 33 USB Application > FTP

The following table describes the labels in this screen.

Table 19 Expert Mode > Applications > File Sharing > FTP

LABEL	DESCRIPTION
Enable FTP	Select this to enable the FTP server on the NBG6818 for file sharing using FTP.
Port	You may change the server port number for FTP if needed, however you must use the same port number in order to use that service for file sharing.
User Accounts	Before you can share files you need a user account. Configure the following fields to set up a file-sharing account.
No.	This is the index number of the user account.
Status	This field displays whether a user account is activated or not. Select the check box to enable the account. Clear the check box to disable the account.
User Name	This field displays the user name that will be allowed to access the shared files.
USB	This field displays the user's access rights to the USB storage device which is connected to the NBG6818's USB port.
Upstream Bandwidth	This field shows the maximum bandwidth (in Kbps) allowed for incoming FTP traffic.
Downstream Bandwidth	This field shows the maximum bandwidth (in Kbps) allowed for outgoing FTP traffic.
Actions	Click the icons under Actions to delete or edit a port forwarding rule. Click  to delete an existing trigger port settings. Click  to edit an existing trigger port settings.
Apply	Click Apply to save your changes back to the NBG6818.
Cancel	Click Cancel to begin configuring this screen afresh.

8.4.2.1 Add FTP Account Screen

Use this screen to configure settings for a FTP account.

Click **USB Application > FTP > Add Rule** to show the following screen.

Figure 34 USB Application > FTP > Add Rule

The following table describes the labels in this screen.

Table 20 USB Application > FTP > Add Rule

LABEL	DESCRIPTION
Status	Select Enable to enable the account. Select Disable to disable the account.
User Name	Enter a user name that will be allowed to access the shared files. You can enter up to 20 characters. Only letters and numbers allowed.
Password	Enter the password used to access the shared files. You can enter up to 20 characters. Only letters and numbers are allowed. The password is case sensitive.
USB	Specify the user's access rights to the USB storage device which is connected to the NBG6818's USB port. Read & Write - The user has read and write rights, meaning that the user can create and edit the files on the connected USB device. Read - The user has read rights only and can not create or edit the files on the connected USB device. None - The user cannot access the files on the USB device(s) connected to the USB port.
Upstream Bandwidth	Enter the maximum bandwidth (in Kbps) allowed for incoming FTP traffic.
Downstream Bandwidth	Enter the maximum bandwidth (in Kbps) allowed for outgoing FTP traffic.
Apply	Click Apply to save your changes back to the NBG6818.
Cancel	Click Cancel to exist the screen without saving.

8.4.3 USB Media Sharing Screen

Use this screen to configure settings for media sharing.

The media server feature lets anyone on your network play video, music, and photos from the USB storage device connected to your NBG6818 without having to copy them to another computer. The NBG6818 can function as a DLNA-compliant media server, where the NBG6818 streams files to DLNA-compliant media clients like Windows Media Player.

The Digital Living Network Alliance (DLNA) is a group of personal computer and electronics companies that works to make products compatible in a home network.

The NBG6818 media server enables you to:

- Publish all share folders for everyone to play media files in the USB storage device connected to the NBG6818.
- Use hardware-based media clients like the DMA-2500 to play the files.

Note: Anyone on your network can play the media files in the published folders. No user name and password nor other form of security is required.

Figure 35 Media Server Overview

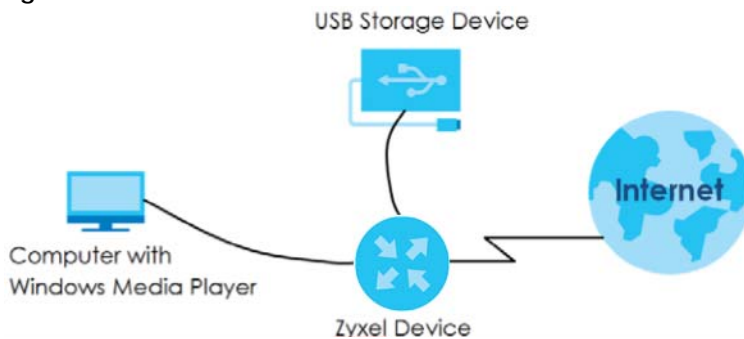

Click **USB Application > USB Media Sharing** to show the following screen.

Figure 36 USB Application > USB Media Sharing

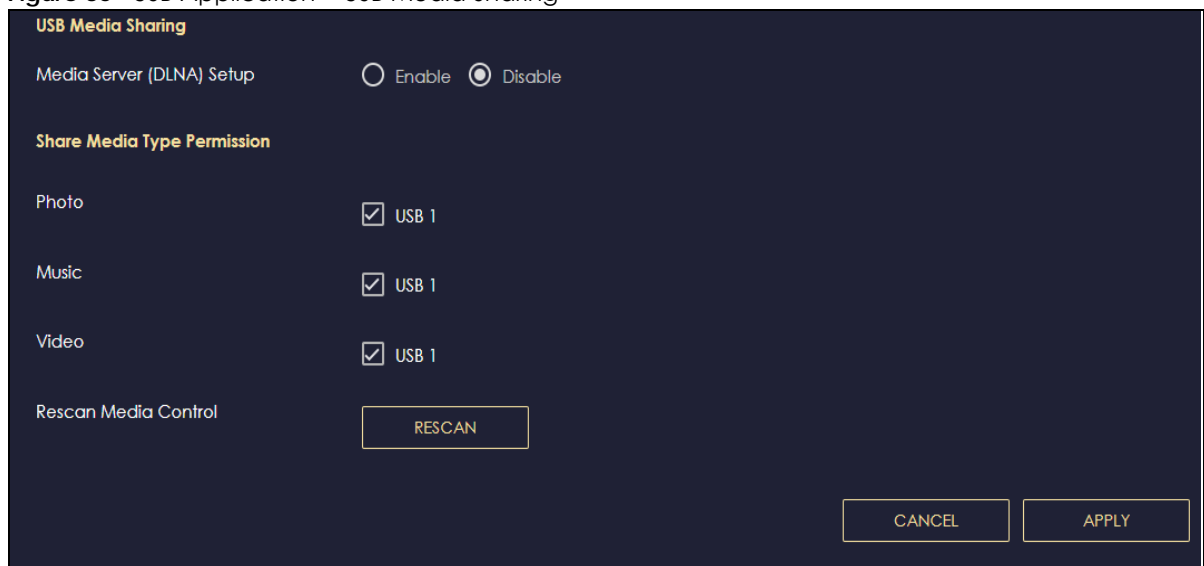

The following table describes the labels in this screen.

Table 21 USB Application > USB Media Sharing

LABEL	DESCRIPTION
USB Media Sharing	
Media Server (DLNA) Setup	Choose Enable to have the NBG6818 function as a DLNA-compliant media server. Otherwise, choose Disable .
Share Media Type Permission	
Photo/Music/Video	Select the media type that you want to share on the USB device connected to the NBG6818's USB port.
Rescan Media Control	
Rescan	Click this button to have the NBG6818 scan the media files on the connected USB device and do indexing of the file list again so that DLNA clients can find the new files if any.
Apply	Click Apply to save your changes back to the NBG6818.
Cancel	Click Cancel to begin configuring this screen afresh.

8.5 Access Your Shared Files From a Computer

8.5.1 Using Windows Explorer

You can use Windows Explorer to access the file storage devices connected to the NBG6818.

Note: The examples in this User's Guide show you how to use Microsoft's Windows 7 to browse your shared files. Refer to your operating system's documentation for how to browse your file structure.

Open Windows Explorer to access **usb1** using the Windows Explorer browser.

In the Windows Explorer's address bar type a double backslash "\\\" followed by the IP address of the NBG6818 (the default IP address of the NBG6818 is 192.168.123.1) and press [ENTER]. The share folder **usb1** is available.

Figure 37 USB1

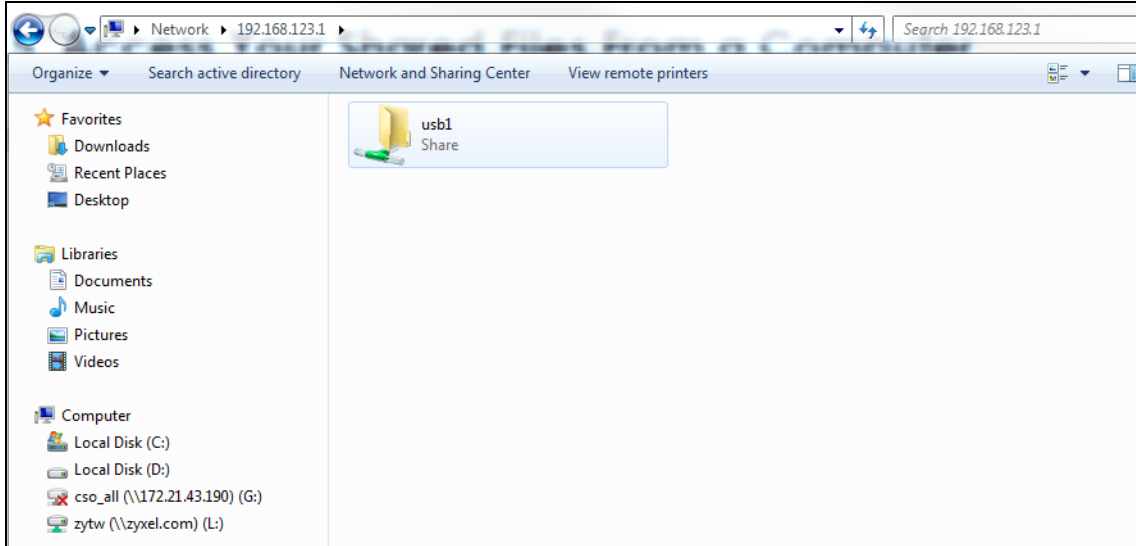

Once you access **usb1** via your NBG6818, you do not have to relogin unless you restart your computer.

8.5.2 Using FTP Program

Here is how to use an FTP program to access a file storage device connected to the NBG6818's USB port.

Note: This example uses the FileZilla FTP program to browse your shared files.

- 1 Download FileZilla and install the FTP software to your computer
- 2 Go to **USB Application > FTP**. On the **FTP Setup** screen, click **Add Rule** to go to the **Add FTP Account** screen. You can use this screen to create a set of **User Name** and **Password** and set up USB rules for file sharing. (See more information at [Section 8.4.2 on page 69](#).) Click **Apply** to save the changes.

Figure 38 Add FTP Account

 A screenshot of the 'Add FTP Account' configuration screen. The screen has a dark background with white text. At the top, it says 'Add FTP Account'. Below this, there are several fields and options:

- Status:** Two radio buttons, 'Enable' (selected) and 'Disable'.
- User Name:** A text input field containing 'NBG'.
- Password:** A text input field with two dots, a toggle icon, and a warning message: 'Special characters ""<>^\$&\ are not allowed. The minimum length is 8 characters.'
- USB:** Three radio buttons: 'None', 'Read' (selected), and 'Read & Write'.
- Upstream Bandwidth:** A text input field containing '1000' and '(KBytes)'.
- Downstream Bandwidth:** A text input field containing '1000' and '(KBytes)'.

 At the bottom right, there are two buttons: 'CANCEL' and 'APPLY'.

- 3 You can click the **Edit** or **Delete** icon to edit or delete the rules.

Figure 39 Add Rule Edit

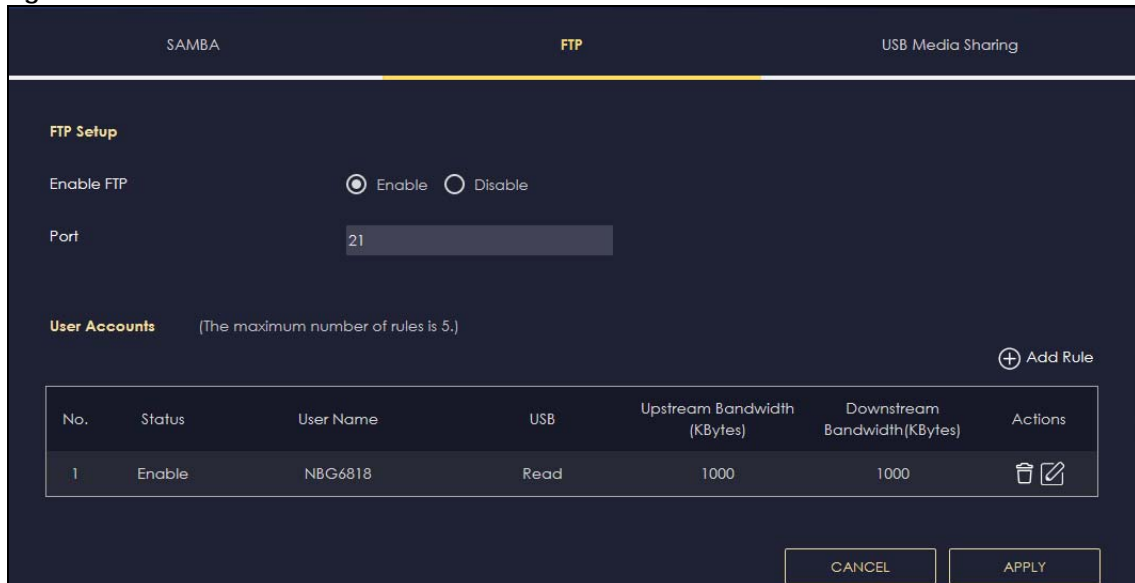

- 4 Open FileZilla, enter the **Host IP** address of the NBG6818 (the default IP address is 192.168.123.1), the **Username** and **Password**, and the **port** number 21, and then click **Quickconnect**. A screen asking for password authentication appears.

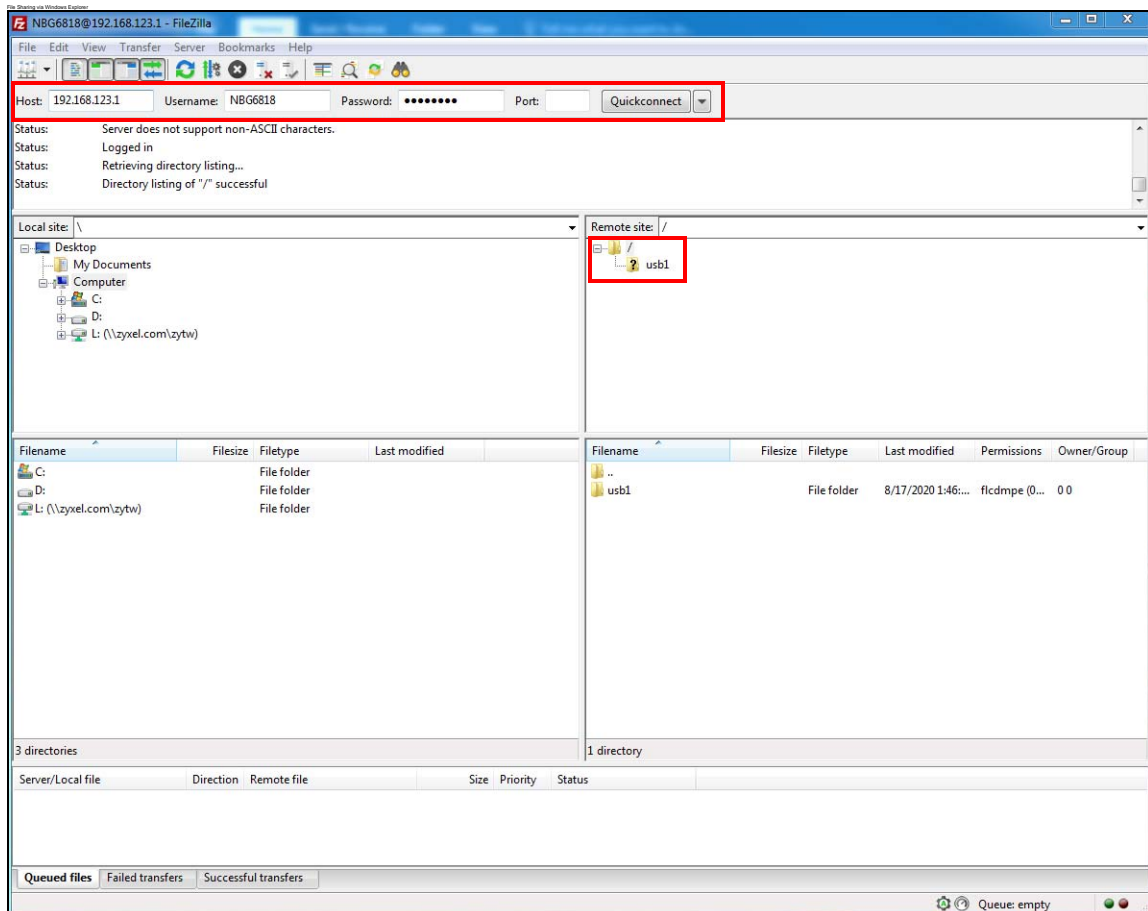

- 5 Once you log in the USB device displays in the **usb1** folder.

CHAPTER 9

WAN

9.1 Overview

This chapter discusses the NBG6818's **WAN** screens. Use these screens to configure your NBG6818 for Internet access.

A WAN (Wide Area Network) connection is an outside connection to another network or the Internet. It connects your private networks such as a LAN (Local Area Network) and other networks, so that a computer in one location can communicate with computers in other locations.

Figure 40 LAN and WAN

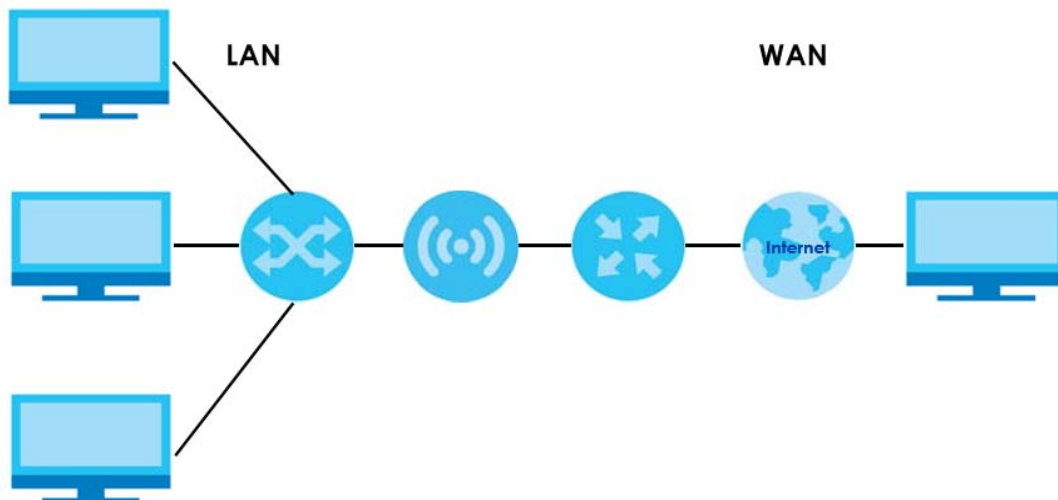

Note: Features in this chapter are not available if you are using bridge mode.

9.2 What You Can Do

- Use the **Internet Connection** screen to enter your ISP information and set how the computer acquires its IP, DNS and WAN MAC addresses ([Section 9.4 on page 79](#)).
- Use the **NAT & Port Forwarding** screen to enable NAT, set a default server and change your NBG6818's port forwarding settings ([Section 9.5 on page 87](#)).
- Use the **Passthrough** screen to configure your NBG6818's ALGs and VPN pass-through settings ([Section 9.6 on page 91](#)).
- Use the **Port Trigger** screen to configure your NBG6818's trigger port settings ([Section 9.7 on page 92](#)).
- Use the **Dynamic DNS** screen to change your NBG6818's DDNS settings ([Section 9.8 on page 95](#)).
- Use the **UPnP** screen to enable UPnP on your NBG6818 ([Section 9.9 on page 96](#)).

9.3 What You Need To Know

The information in this section can help you configure the screens for your WAN connection, as well as enable/disable some advanced features of your NBG6818.

9.3.1 Configuring Your Internet Connection

Encapsulation Method

Encapsulation is used to include data from an upper layer protocol into a lower layer protocol. To set up a WAN connection to the Internet, you need to use the same encapsulation method used by your ISP (Internet Service Provider). If your ISP offers a dial-up Internet connection using PPPoE (PPP over Ethernet) or PPTP (Point-to-Point Tunneling Protocol), they should also provide a username and password (and service name) for user authentication.

WAN IP Address

The WAN IP address is an IP address for the NBG6818, which makes it accessible from an outside network. It is used by the NBG6818 to communicate with other devices in other networks. It can be static (fixed) or dynamically assigned by the ISP each time the NBG6818 tries to access the Internet.

If your ISP assigns you a static WAN IP address, they should also assign you the subnet mask and DNS server IP address(es) (and a gateway IP address if you use the Ethernet or ENET ENCAP encapsulation method).

DNS Server Address Assignment

Use Domain Name System (DNS) to map a domain name to its corresponding IP address and vice versa, for instance, the IP address of www.zyxel.com is 204.217.0.2. The DNS server is extremely important because without it, you must know the IP address of a computer before you can access it.

The NBG6818 can get the DNS server addresses in the following ways.

- 1 The ISP tells you the DNS server addresses, usually in the form of an information sheet, when you sign up. If your ISP gives you DNS server addresses, manually enter them in the DNS server fields.
- 2 If your ISP dynamically assigns the DNS server IP addresses (along with the NBG6818's WAN IP address), set the DNS server fields to get the DNS server address from the ISP.

WAN MAC Address

The MAC address screen allows users to configure the WAN port's MAC address by either using the factory default or cloning the MAC address from a computer on your LAN. Choose **Factory Default** to select the factory assigned default MAC Address.

Otherwise, click **Clone the computer's MAC address - IP Address** and enter the IP address of the computer on the LAN whose MAC you are cloning. Once it is successfully configured, the address will be copied to configuration file. It is recommended that you clone the MAC address prior to hooking up the WAN Port.

Auto-IP Change

When the NBG6818 gets a WAN IP address or a DNS server IP address which is in the same subnet as the LAN IP address 192.168.123.1, Auto-IP-Change allows the NBG6818 to change its LAN IP address to 10.0.0.1 automatically. If the NBG6818's original LAN IP address is 10.0.0.1 and the WAN IP address is in the same subnet, such as 10.0.0.3, the NBG6818 switches to use 192.168.123.1 as its LAN IP address.

Figure 41 Auto-IP-Change Example

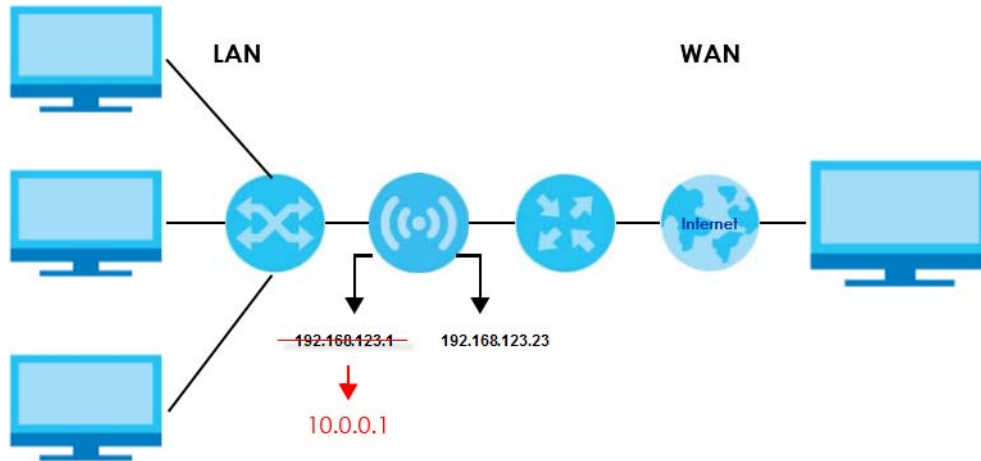

Auto-IP-Change only works under the following conditions:

- The NBG6818 must be in **Standard Mode** (see [Section 13.7 on page 137](#) for more information) for Auto-IP-Change to become active.
- The NBG6818 is set to receive a dynamic WAN IP address.

9.4 Internet Connection Screen

Use this screen to change your NBG6818's Internet access settings. The screen varies depending on the encapsulation method you select. Click **Settings > Internet > Internet Connection**.

9.4.1 IPoE Encapsulation

This screen displays when you select **IPoE** encapsulation.

Figure 42 Settings > Internet > Internet Connection: IPoE (IPv4 Only)

The following table describes the labels in this screen.

Table 22 Network > WAN > Internet Connection: IPoE Encapsulation

LABEL	DESCRIPTION
Internet Connection	
Internet Service Provider Type	You must choose the IPoE option when the WAN port is used as a regular Ethernet.
IPv4 / IPv6	Select IPv4 Only if you want the NBG6818 to run IPv4 only. Select Dual Stack to allow the NBG6818 to run IPv4 and IPv6 at the same time.
IPv4 Address	
Automatic IP (DHCP)	Select this option If your ISP did not assign you a fixed IP address. This is the default selection.

Table 22 Network > WAN > Internet Connection: IPoE Encapsulation (continued)

LABEL	DESCRIPTION
Static IP	Select this option if the ISP assigned a fixed IP address.
IP Address	Enter your WAN IP address in this field if you selected Static IP Address .
IP Subnet Mask	Enter the Subnet Mask in this field.
Gateway	Enter a gateway IP address (if your ISP gave you one) in this field.
MTU Size	Enter the MTU (Maximum Transmission Unit) size for each packet. If a larger packet arrives, the NBG6818 divides it into smaller fragments.
DNS Server	
First DNS Server	Select User-Defined if you have the IP address of a DNS server. Enter the DNS server's IP address in the field to the right.
Second DNS Server	Select None if you do not want to configure DNS servers. If you do not configure a DNS server, you must know the IP address of a computer in order to access it.
Third DNS Server	
WAN MAC Address	
Once the WAN MAC address is successfully configured, the address will be copied to the configuration file. It will not change unless you change the setting or upload a different configuration file.	
Factory Default	Select this option to have the WAN interface use the factory assigned default MAC address. By default, the NBG6818 uses the factory assigned MAC address to identify itself.
Clone My Computer's MAC Address	Select this option to have the WAN interface use a different MAC address by cloning the MAC address of another device or computer. Enter the IP address of the device or computer whose MAC you are cloning.
Set WAN MAC Address	Select this option to have the WAN interface use a manually specified MAC address. Enter the MAC address in the fields.
LAN & WAN Subnet Conflict	
Automatically change the LAN IP	Select this option to have the NBG6818 change its LAN IP address to 10.0.0.1 or 192.168.123.1 accordingly when the NBG6818 gets a dynamic WAN IP address in the same subnet as the LAN IP address. See Section 9.3.1 on page 78 for more information. The NAT, DHCP server and firewall functions on the NBG6818 are still available in this mode.
IPv6 Address	
This section is NOT available when you select IPv4 Only in the IPv4/IPv6 field.	
Automatic IP (DHCP)	Select this option if you want to obtain an IPv6 address from a DHCPv6 server. <ul style="list-style-type: none"> Select DUID-LL (Default) to have the NBG6818 use DUID-LL (DUID Based on Link-layer Address) for identification when exchanging DHCPv6 messages. Select DUID-LLT to have the NBG6818 use DUID-LLT (DUID Based on Link-layer Address Plus Time) for identification when exchanging DHCPv6 messages.
Static IP Address	Select this option if you have a fixed IPv6 address assigned by your ISP.
IPv6 Address	Enter the IPv6 address assigned by your ISP.
Prefix length	Enter the address prefix length to specify how many most significant bits in an IPv6 address compose the network address.
Gateway	Enter the IPv6 address of the next-hop gateway. The gateway helps forward packets to their destinations.
Link Local Only	Select this option to use the link-local address which uniquely identifies a device on the local network (the LAN).
IPv6 DNS Server	
This section is NOT available when you select IPv4 Only in the IPv4/IPv6 field.	

Table 22 Network > WAN > Internet Connection: IPoE Encapsulation (continued)

LABEL	DESCRIPTION
First DNS Server	Select User-Defined and enter the IPv6 DNS server address assigned by the ISP to have the NBG6818 use the IPv6 DNS server addresses you configure manually.
Second DNS Server	
Third DNS Server	Select None if you do not want to configure DNS servers. If you do not configure a DNS server, you must know the IPv6 address of a computer in order to access it.
Apply	Click Apply to save your changes back to the NBG6818.
Cancel	Click Cancel to begin configuring this screen afresh.

9.4.2 PPPoE Encapsulation

The NBG6818 supports PPPoE (Point-to-Point Protocol over Ethernet). PPPoE is an IETF standard (RFC 2516) specifying how a personal computer (PC) interacts with a broadband modem (DSL, cable, wireless, etc.) connection. The **PPP over Ethernet** option is for a dial-up connection using PPPoE.

For the service provider, PPPoE offers an access and authentication method that works with existing access control systems (for example Radius).

One of the benefits of PPPoE is the ability to let you access one of multiple network services, a function known as dynamic service selection. This enables the service provider to easily create and offer new IP services for individuals.

Operationally, PPPoE saves significant effort for both you and the ISP or carrier, as it requires no specific configuration of the broadband modem at the customer site.

By implementing PPPoE directly on the NBG6818 (rather than individual computers), the computers on the LAN do not need PPPoE software installed, since the NBG6818 does that part of the task. Furthermore, with NAT, all of the LANs' computers will have access.

This screen displays when you select **PPPoE** encapsulation.

Figure 43 Settings > Internet > Internet Connection: PPPoE (IPv4 Only)

The screenshot shows the following configuration options:

- Internet Connection:**
 - Internet Service Provider Type: IPoE, PPPoE, PPTP
 - IPv4 / IPv6: IPv4 Only (dropdown)
 - PPPoE Username: [text input]
 - Password: [password input]
 - MTU Size: 1492
 - Service Name: [text input]
- DNS Server:**
 - First DNS Server: User-Defined (dropdown), 0.0.0.0 (text input)
 - Second DNS Server: User-Defined (dropdown), 0.0.0.0 (text input)
 - Third DNS Server: User-Defined (dropdown), 0.0.0.0 (text input)
- WAN IP Address Assignment:**
 - Obtained From ISP
 - Fixed IP
 - IP Address: [text input]
- WAN MAC:**
 - Factory Default
 - Clone My Computer's MAC Address
 - Set WAN MAC Address
 - Set WAN MAC Address: [text input]
- LAN & WAN Subnet Conflict:**
 - Automatically change the LAN IP: Enable, Disable

The following table describes the labels in this screen.

Table 23 Network > WAN > Internet Connection: PPPoE Encapsulation

LABEL	DESCRIPTION
Internet Connection	
Internet Service Provider Type	Select PPPoE if you connect to your Internet via dial-up.
IPv4 / IPv6	Select IPv4 Only if you want the NBG6818 to run IPv4 only. Select Dual Stack to allow the NBG6818 to run IPv4 and IPv6 at the same time.
PPPoE Username	Type the user name given to you by your ISP.

Table 23 Network > WAN > Internet Connection: PPPoE Encapsulation (continued)

LABEL	DESCRIPTION
Password	Type the password associated with the user name above.
MTU Size	Enter the Maximum Transmission Unit (MTU) or the largest packet size per frame that your NBG6818 can receive and process.
Service Name	Enter the PPPoE service name specified in the ISP account.
DNS Server	
First DNS Server	Select User-Defined if you have the IP address of a DNS server. Enter the DNS server's IP address in the field to the right.
Second DNS Server	Select None if you do not want to configure DNS servers. If you do not configure a DNS server, you must know the IP address of a computer in order to access it.
Third DNS Server	
WAN IP Address Assignment	
Obtained from ISP	Select this option if your ISP did not assign you a fixed IP address. This is the default selection.
Fixed IP	Select this option and enter your WAN IP address if the ISP assigned a fixed IP address.
WAN MAC Address	
The MAC address section allows users to configure the WAN port's MAC address by using the NBG6818's MAC address, copying the MAC address from a computer on your LAN or manually entering a MAC address.	
Factory Default	Select Factory default to use the factory assigned default MAC Address.
Clone My Computer's MAC Address	Select Clone the computer's MAC address - IP Address and enter the IP address of the computer on the LAN whose MAC you are cloning.
Set WAN MAC Address	Select this option and enter the MAC address you want to use.
IPv6 Address	
This section is NOT available when you select IPv4 Only in the IPv4/IPv6 field.	
Automatic IP (DHCP)	Select this option if you want to obtain an IPv6 address from a DHCPv6 server. <ul style="list-style-type: none"> Select DUID-LL (Default) to have the NBG6818 use DUID-LL (DUID Based on Link-layer Address) for identification when exchanging DHCPv6 messages. Select DUID-LLT to have the NBG6818 use DUID-LLT (DUID Based on Link-layer Address Plus Time) for identification when exchanging DHCPv6 messages.
Static IP Address	Select this option if you have a fixed IPv6 address assigned by your ISP.
IPv6 Address	Enter the IPv6 address assigned by your ISP.
Prefix length	Enter the address prefix length to specify how many most significant bits in an IPv6 address compose the network address.
Gateway	Enter the IPv6 address of the next-hop gateway. The gateway helps forward packets to their destinations.
Link Local Only	Select this option to use the link-local address which uniquely identifies a device on the local network (the LAN).
IPv6 DNS Server	
This section is NOT available when you select IPv4 Only in the IPv4/IPv6 field.	
First DNS Server	Select User-Defined and enter the IPv6 DNS server address assigned by the ISP to have the NBG6818 use the IPv6 DNS server addresses you configure manually.
Second DNS Server	Select None if you do not want to configure DNS servers. If you do not configure a DNS server, you must know the IPv6 address of a computer in order to access it.
Third DNS Server	
LAN & WAN Subnet Conflict	

Table 23 Network > WAN > Internet Connection: PPPoE Encapsulation (continued)

LABEL	DESCRIPTION
Automatically change the LAN IP	Select this option to have the NBG6818 change its LAN IP address to 10.0.0.1 or 192.168.123.1 accordingly when the NBG6818 gets a dynamic WAN IP address in the same subnet as the LAN IP address. See Section 9.3.1 on page 78 for more information. The NAT, DHCP server and firewall functions on the NBG6818 are still available in this mode.
Apply	Click Apply to save your changes back to the NBG6818.
Cancel	Click Cancel to begin configuring this screen afresh.

9.4.3 PPTP Encapsulation

This screen displays when you select **PPTP** encapsulation.

Figure 44 Settings > Internet > Internet Connection: PPTP (IPv4 Only)

Internet Connection

Internet Service Provider Type IPoE PPPoE PPTP

PPTP Username

Password

PPTP Encryption Type

MTU Size

PPTP Server IP Address

Auto Connect

Static IP

DNS Server

First DNS Server

Second DNS Server

Third DNS Server

WAN IP Address Assignment

Obtained From ISP

Fixed IP

IP Address

WAN MAC

Factory Default

Clone My Computer's MAC Address

Set WAN MAC Address

Set WAN MAC Address

LAN & WAN Subnet Conflict

Automatically change the LAN IP Enable Disable

The following table describes the labels in this screen.

Table 24 Network > WAN > Internet Connection: PPTP Encapsulation

LABEL	DESCRIPTION
Internet Connection	
Internet Service Provider Type	Select PPTP if you want to connect the Internet via point to point tunneling protocol.
PPTP Username	Enter the user name given to you by your ISP.
Password	Enter the password associated with the user name above.
PPTP Encryption Type	Use the drop-down list box to select the type of Microsoft Point-to-Point Encryption (MPPE). Options are: Auto - This ISP account adjusts the encryption type automatically. None - This ISP account does not use MPPE. 40 - This ISP account uses 40-bit MPPE. 128 - This ISP account uses 128-bit MPPE.
MTU Size	Enter the MTU (Maximum Transmission Unit) size for each packet. If a larger packet arrives, the NBG6818 divides it into smaller fragments.
PPTP Server IP Address	Enter the IP address of the PPTP server.
Auto Connect	Select this radio button if the PPTP server did not assign you a fixed IP address.
Static IP	Select this radio button if the PPTP server assigned an IP address for your Internet connection.
IP Address	Enter the IP address provided by the PPTP server.
IP Subnet Mask	Enter the IP subnet mask in this field.
Gateway	Enter the gateway IP address in this field.
DNS Server	
First DNS Server	Select User-Defined if you have the IP address of a DNS server. Enter the DNS server's IP address in the field to the right. Select None if you do not want to configure DNS servers. If you do not configure a DNS server, you must know the IP address of a computer in order to access it.
Second DNS Server	
Third DNS Server	
WAN IP Address Assignment	
Obtained from ISP	Select this option If your ISP did not assign you a fixed IP address. This is the default selection.
Fixed IP	Select this option If the ISP assigned a fixed IP address.
IP Address	Enter your WAN IP address in this field if you selected IP Address .
WAN MAC Address	
Once the WAN MAC address is successfully configured, the address will be copied to the configuration file. It will not change unless you change the setting or upload a different configuration file.	
Factory Default	Select this option to have the WAN interface use the factory assigned default MAC address. By default, the NBG6818 uses the factory assigned MAC address to identify itself.
Clone My Computer's MAC Address	Select this option to have the WAN interface use a different MAC address by cloning the MAC address of another device or computer. Enter the IP address of the device or computer whose MAC you are cloning.
Set WAN MAC Address	Select this option to have the WAN interface use a manually specified MAC address. Enter the MAC address in the fields.
LAN & WAN Subnet Conflict	

Table 24 Network > WAN > Internet Connection: PPTP Encapsulation (continued)

LABEL	DESCRIPTION
Automatically change the LAN IP	Select this option to have the NBG6818 change its LAN IP address to 10.0.0.1 or 192.168.123.1 accordingly when the NBG6818 gets a dynamic WAN IP address in the same subnet as the LAN IP address. See Section 9.3.1 on page 78 for more information. The NAT, DHCP server and firewall functions on the NBG6818 are still available in this mode.
Apply	Click Apply to save your changes back to the NBG6818.
Cancel	Click Cancel to begin configuring this screen afresh.

9.5 NAT & Port Forwarding Screen

Use Port Forwarding to forward incoming service requests from the Internet to the server(s) on your local network. Port forwarding is commonly used when you want to host online gaming, P2P file sharing, or other servers on your network.

You may enter a single port number or a range of port numbers to be forwarded, and the local IP address of the desired server. The port number identifies a service; for example, web service is on port 80 and FTP on port 21. In some cases, such as for unknown services or where one server can support more than one service (for example both FTP and web service), it might be better to specify a range of port numbers. You can allocate a server IP address that corresponds to a port or a range of ports.

Note: TCP port 7547 is reserved for system use.

Note: Many residential broadband ISP accounts do not allow you to run any server processes (such as a Web or FTP server) from your location. Your ISP may periodically check for servers and may suspend your account if it discovers any active services at your location. If you are unsure, refer to your ISP.

Configuring Servers Behind Port Forwarding (Example)

Let's say you want to assign ports 21-25 to one FTP, Telnet and SMTP server (A in the example), port 80 to another (B in the example) and assign a default server IP address of 192.168.123.35 to a third (C in the example). You assign the LAN IP addresses and the ISP assigns the WAN IP address. The NAT network appears as a single host on the Internet.

Figure 45 Multiple Servers Behind NAT Example

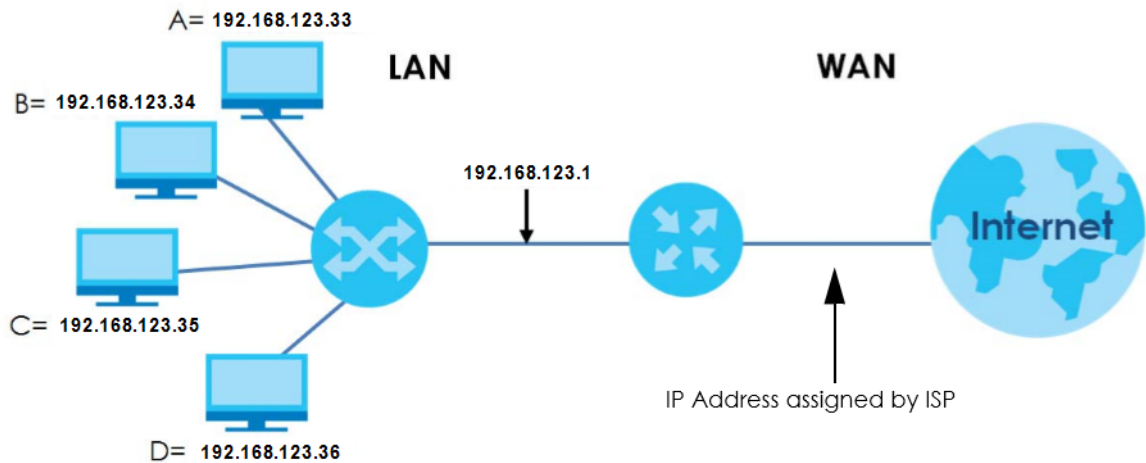

Use this screen to enable NAT, set a default server and view the summary table of your NBG6818's port forwarding settings. Click **Settings > Internet > NAT & Port Forwarding** to show the following screen.

Figure 46 Settings > Internet > NAT & Port Forwarding

NAT & Port Forwarding

Network Address Translation (NAT) Enable Disable

Server Setup Default Server - 192.168.123.1
 Change to Server
TWNBNT02231-02

Port Forwarding Rule (The maximum number of rules is 32.)



Enable Port Forwarding Enable Disable ⊕ Add Rule

No.	Name	Protocol	External Port	Server IP Address	Internal Port	Actions
1	WWW	TCP/UDP	10	192.168.123.143	3	🗑️

CANCEL
APPLY

The following table describes the labels in this screen.

Table 25 Expert Mode > WAN > NAT > General

LABEL	DESCRIPTION
NAT & Port Forwarding	
Network Address Translation (NAT)	Network Address Translation (NAT) allows the translation of an Internet protocol address used within one network (for example a private IP address used in a local network) to a different IP address known within another network (for example a public IP address used on the Internet). Select Enable to activate NAT. Select Disable to turn it off.
Server Setup	
Default Server	You can decide whether you want to use the default server or specify a server manually. In addition to the servers for specified services, NAT supports a default server. A default server receives packets from ports that are not specified in the port forwarding summary table below. Select this to use the default server.
Change To Server	Select this and manually enter the server's IP address.
Port Forwarding Rule	
Enable Port Forwarding	Select Enable to allow port forwarding. Otherwise, select Disable .
No.	This number uniquely identifies the port forwarding rule.
Name	This field displays a name to identify this rule.
Protocol	This is the transport layer protocol used for the service.
External Port	This is the port number used to connect to this service using the router's external IP address on the WAN.
Server IP Address	This field displays the internal IP address of the server.
Internal Port	This is the port number used to connect to this service using the server's internal IP address on the LAN.
Actions	Click the icons under Actions to delete or edit a port forwarding rule. Click  to delete the rule. Click  to edit the rule.
Apply	Click Apply to save your changes back to the NBG6818.
Cancel	Click Cancel to begin configuring this screen afresh.

9.5.1 Add Port Forwarding Rule Screen

Use this screen to configure your NBG6818's port forwarding settings to forward incoming service requests to the servers on your local network. Click **Settings > Internet > NAT & Port Forwarding > Add Rule** to show the following screen.

Figure 47 Add Port Forwarding Rule

The following table describes the labels in this screen.

Table 26 Add Port Forwarding Rule

LABEL	DESCRIPTION
Service Name	Select a pre-defined service from the drop-down list box. The pre-defined service port number(s) and protocol will be displayed in the port forwarding summary table. Otherwise, select User-Define to manually enter the port number/range and select the Protocol .
Protocol	Select the transport layer protocol supported by this virtual server. Choices are TCP , UDP , or TCP_UDP . If you have chosen a pre-defined service in the Service Name field, the protocol will be configured automatically.
External Port	This shows the port number used to connect to this service using the router's external IP address on the WAN. If you select User-Define in the Service Name field, enter the port number(s) manually.
Device List	Select the internal IP address of the virtual server.
Internal Port	This shows the port number used to connect to this service using the server's internal IP address on the LAN. If you select User-Define in the Service Name field, enter an internal port number manually or leave the field blank for port range forwarding.
Apply	Click Apply to save your changes.
Cancel	Click Cancel to exist this screen without saving.

9.6 Passthrough Screen

Use this screen to change your NBG6818's ALGs and VPN pass-through settings. Click **Settings > Internet > Passthrough** to show the following screen.

ALG Overview

Application Layer Gateway (ALG) allows the following applications to operate properly through the NBG6818's NAT.

- SIP - Session Initiation Protocol (SIP) - An application-layer protocol that can be used to create voice and multimedia sessions over Internet.
- H.323 - A teleconferencing protocol suite that provides audio, data and video conferencing.
- FTP - File Transfer Protocol - an Internet file transfer service.
- SNMP - Simple Network Management Protocol - An application-layer protocol that can be used to exchange management information between network devices.
- RTSP - Real Time Streaming Protocol - An application-layer protocol that can be used to stop, pause or play video and audio applications streaming on the Internet.
- IRC - Internet Relay Chat - An application-layer protocol that can control the relay chat applications and allow clients to have real-time communications with others on the Internet.

The ALG feature is only needed for traffic that goes through the NBG6818's NAT.

Figure 48 Settings > Internet > Passthrough

ALG Setup

FTP	<input checked="" type="radio"/> Enable	<input type="radio"/> Disable
H.323	<input checked="" type="radio"/> Enable	<input type="radio"/> Disable
SIP	<input checked="" type="radio"/> Enable	<input type="radio"/> Disable
SNMP	<input checked="" type="radio"/> Enable	<input type="radio"/> Disable
RTSP	<input checked="" type="radio"/> Enable	<input type="radio"/> Disable
IRC	<input checked="" type="radio"/> Enable	<input type="radio"/> Disable

VPN Passthrough

PPTP	<input checked="" type="radio"/> Enable	<input type="radio"/> Disable
L2TP	<input checked="" type="radio"/> Enable	<input type="radio"/> Disable
IPSEC	<input checked="" type="radio"/> Enable	<input type="radio"/> Disable

CANCEL APPLY

The following table describes the labels in this screen.

Table 27 Settings > Internet > Passthrough

LABEL	DESCRIPTION
ALG Setup	
FTP	Select Enable to allow TCP packets with a specified port destination to pass through.
H.323	Select Enable to allow peer-to-peer H.323 calls.
SIP	Select Enable to make sure SIP (VoIP) works correctly with port-forwarding and address-mapping rules.
SNMP	Select Enable to allow a manager station to manage and monitor the NBG6818 through the network via SNMP.
RTSP	Select Enable to have the NBG6818 detect RTSP traffic and help build RTSP sessions through its NAT.
IRC	Select Enable to allow clients to have real-time communications with others on the Internet.
VPN Passthrough	
PPTP	Select Enable to allow VPN clients to make outbound PPTP connections. It is required in order to connect to a PPTP VPN account. If PPTP is disabled, then when a client sends a request to a VPN server, the server will reply to the NBG6818 and the NBG6818 will drop the request. When PPTP is enabled, the NBG6818 will forward the reply from the VPN server to the client that initiated the request, and the connection will establish successfully.
L2TP	Select Enable to allow VPN clients to make outbound L2TP connections. It is required in order to connect to a L2TP VPN account. If L2TP is disabled, then when a client sends a request to a VPN server, the server will reply to the NBG6818 and the NBG6818 will drop the request. When L2TP is enabled, the NBG6818 will forward the reply from the VPN server to the client that initiated the request, and the connection will establish successfully.
IPSEC	Select Enable to allow VPN clients to make outbound IPsec connections. It is required in order to connect to a IPsec VPN account. If IPSEC is disabled, then when a client sends a request to a VPN server, the server will reply to the NBG6818 and the NBG6818 will drop the request. When IPSEC is enabled, the NBG6818 will forward the reply from the VPN server to the client that initiated the request, and the connection will establish successfully.
Apply	Click Apply to save your changes back to the NBG6818.
Cancel	Click Cancel to begin configuring this screen afresh.

9.7 Port Trigger Screen

Some services use a dedicated range of ports on the client side and a dedicated range of ports on the server side. With regular port forwarding, you set a forwarding port in NAT to forward a service (coming in from the server on the WAN) to the IP address of a computer on the client side (LAN). The problem is that port forwarding only forwards a service to a single LAN IP address. In order to use the same service on a different LAN computer, you have to manually replace the LAN computer's IP address in the forwarding port with another LAN computer's IP address.

Trigger port forwarding addresses this problem. Trigger port forwarding allows computers on the LAN to dynamically take turns using the service. The Zyxel Device records the IP address of a LAN computer that sends traffic to the WAN to request a service with a specific port number and protocol (a "trigger" port). When the Zyxel Device's WAN port receives a response with a specific port number and protocol ("open" port), the Zyxel Device forwards the traffic to the LAN IP address of the computer that sent the request. After that computer's connection for that service closes, another computer on the LAN can use the service in the same manner. This way you do not need to configure a new IP address each time you want a different LAN computer to use the application.

Note: TCP port 7547 is reserved for system use.

Note: The maximum number of trigger ports for a single rule or all rules is 999.

Note: The maximum number of open ports for a single rule or all rules is 999.

Figure 49 Trigger Port Forwarding Process: Example

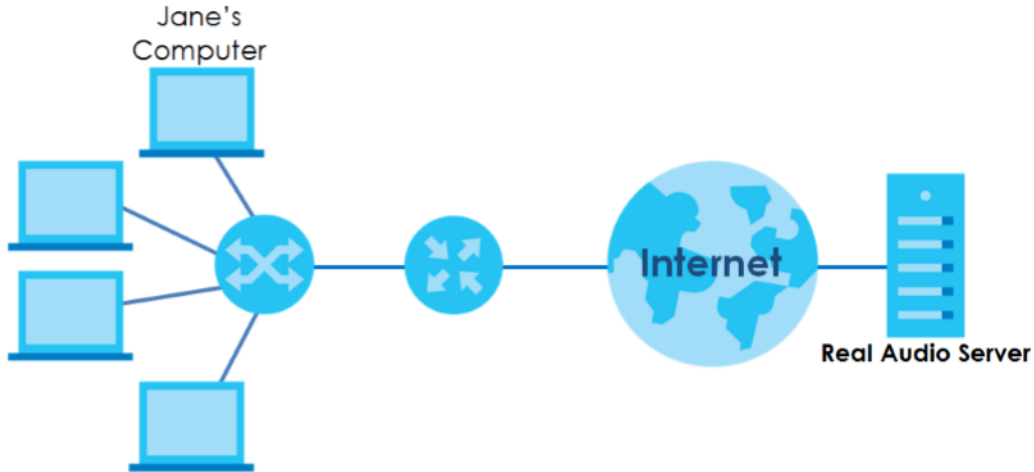

- 1 Jane requests a file from the Real Audio server (port 7070).
- 2 Port 7070 is a "trigger" port and causes the Zyxel Device to record Jane's computer IP address. The Zyxel Device associates Jane's computer IP address with the "open" port range of 6970-7170.
- 3 The Real Audio server responds using a port number ranging between 6970-7170.
- 4 The Zyxel Device forwards the traffic to Jane's computer IP address. Only Jane can connect to the Real Audio server until the connection is closed or times out. The Zyxel Device times out in three minutes with UDP (User Datagram Protocol) or two hours with TCP/IP (Transfer Control Protocol/Internet Protocol).

Use this screen to view the summary table of your NBG6818's port trigger settings. Click **Expert Mode > WAN > NAT > Port Trigger** to show the following screen.

Note: Only one LAN computer can use a trigger port (range) at a time.

Figure 50 Expert Mode > WAN > NAT > Port Trigger



No.	Name	Incoming Port	End Port	Trigger Port	End Port	Actions
1	A	3	5	4	6	

The following table describes the labels in this screen.

Table 28 Expert Mode > WAN > NAT > Port Trigger

LABEL	DESCRIPTION
Port Trigger Rules (Max Limit: 32)	
No.	This is the rule index number.

Table 28 Expert Mode > WAN > NAT > Port Trigger (continued)

LABEL	DESCRIPTION
Name	This field displays a name to identify this rule.
Incoming Port	This field displays a port number that a server on the WAN uses when it sends out a particular service.
End Port	This field displays a port number or the final port number in a range of port numbers.
Trigger Port	This field displays a port number that causes the NBG6818 to record the IP address of the LAN computer that sent then traffic to a server on the WAN.
End Port	This field displays a port number or the ending port number in a range of port numbers.
Actions	Click the icons under Actions to delete or edit an existing trigger port settings. Click  to delete the rule. Click  to edit the rule.

9.7.1 Add Port Trigger Rule Screen

Use this screen to configure your NBG6818's port trigger settings. Click **Expert Mode > WAN > NAT > Port Trigger > Add Rule** to show the following screen.

Figure 51 Add Port Trigger Rule

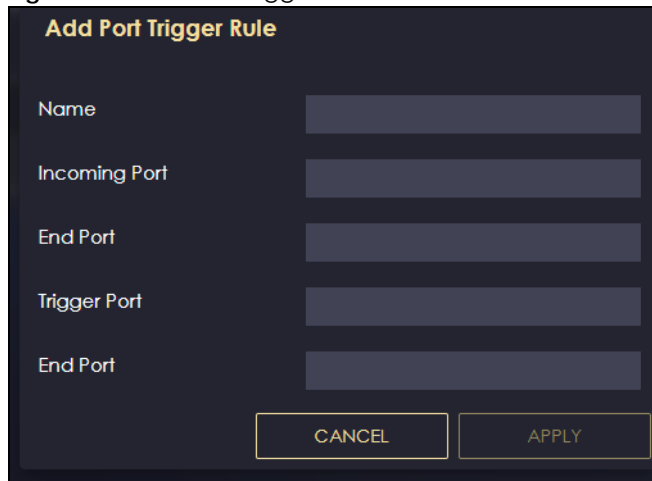

Table 29 Add Port Trigger Rule

LABEL	DESCRIPTION
Name	Type a unique name (up to 15 characters) for identification purposes. All characters are permitted - including spaces.
Incoming Port	Incoming is a port (or a range of ports) that a server on the WAN uses when it sends out a particular service. The ARMOR Z1 forwards the traffic with this port (or range of ports) to the client computer on the LAN that requested the service. Type a port number or the starting port number in a range of port numbers.
End Port	Type a port number or the ending port number in a range of port numbers.
Trigger Port	The trigger port is a port (or a range of ports) that causes (or triggers) the ARMOR Z1 to record the IP address of the LAN computer that sent the traffic to a server on the WAN. Type a port number or the starting port number in a range of port numbers.
End Port	Type a port number or the ending port number in a range of port numbers.

Table 29 Add Port Trigger Rule

LABEL	DESCRIPTION
Apply	Click Apply to save your changes.
Cancel	Click Cancel to exist this screen without saving.

9.8 Dynamic DNS Screen

Use this screen to change your NBG6818's DDNS settings. Click **Settings > Internet > Dynamic DNS** to show the following screen.

Note: You can register at <https://mycloud.zyxel.com/> to get a free accessible-from-anywhere DDNS account.

Figure 52 Settings> Internet > Dynamic DNS

Dynamic DNS

Dynamic DNS Enable Disable

Service Provider

Host Name .zyxel.me

User Name

Password

DNS maps a domain name to a corresponding IP address and vice versa. Similarly, Dynamic DNS (DDNS) maps a domain name to a dynamic IP address. With DDNS, you can use a domain name to access your ZyXEL device and home network regardless of the device's current (dynamic) IP address. The ZyXEL device must have a public WAN IP address to use Dynamic DNS. Register at <https://mycloud.zyxel.com/> and get a free accessible-from-anywhere network name as well as other ZyXEL services.

The following table describes the labels in this screen.

Table 30 Settings > Internet > Dynamic DNS

LABEL	DESCRIPTION
Dynamic DNS Setup	
Dynamic DNS	Select Enable to use dynamic DNS. Select Disable to turn this feature off.
Service Provider	Select the name of your Dynamic DNS service provider.
Host Name	Enter a host names in the field provided. You can specify up to two host names in the field separated by a comma (",").

Table 30 Settings > Internet > Dynamic DNS (continued)

LABEL	DESCRIPTION
Username	Enter your user name.
Password	Enter the password assigned to you.
Apply	Click Apply to save your changes back to the NBG6818.
Cancel	Click Cancel to begin configuring this screen afresh.

9.9 UPnP Screen

Universal Plug and Play (UPnP) is a distributed, open networking standard that uses TCP/IP for simple peer-to-peer network connectivity between devices. A UPnP device can dynamically join a network, obtain an IP address, convey its capabilities, and learn about other devices on the network. A device can then leave a network smoothly and automatically when it is no longer in use.

See [Section 9.9.1 on page 97](#) and [Section 9.9.2 on page 99](#) for more information on UPnP.

Use this screen to enable UPnP on your NBG6818. Click **Settings > Internet > UPnP** to display the following screen.

Figure 53 Settings > Internet > UPnP

Table 31 Settings > Internet > UPnP

LABEL	DESCRIPTION
UPnP Setup	
Enable UPnP	Select Enable to activate UPnP. Be aware that anyone could use a UPnP application to open the web configurator's login screen without entering the NBG6818's IP address (although you must still enter the password to access the web configurator).
UPnP Setup Rule	
No.	This is the number of an individual UPnP entry.
Protocol	This is the transport layer protocol used for the service.
InPort	InPort is a port that a LAN computer uses when it requests a particular service. This port is only applicable to the local network. This field displays the port number of the UPnP entry.
OutPort	OutPort is the well-known port that the WAN server uses to reply to the LAN computer that made the request using In Port. This field displays the port number of the UPnP entry.

Table 31 Settings > Internet > UPnP

LABEL	DESCRIPTION
IP Address	This field displays the IP address of this UPnP entry.
Apply	Click Apply to save your settings.
Cancel	Click Cancel to return to the previously saved settings.

9.9.1 Turning On UPnP in Windows 7 Example

This section shows you how to use the UPnP feature in Windows 7. UPnP server is installed in Windows 7. Activate UPnP on the NBG6818 in **Settings > Internet > UPnP**.

Make sure the computer is connected to a LAN port of the NBG6818. Turn on your computer and the NBG6818.

- 1 Click the start icon, **Control Panel** and then the **Network and Sharing Center**.

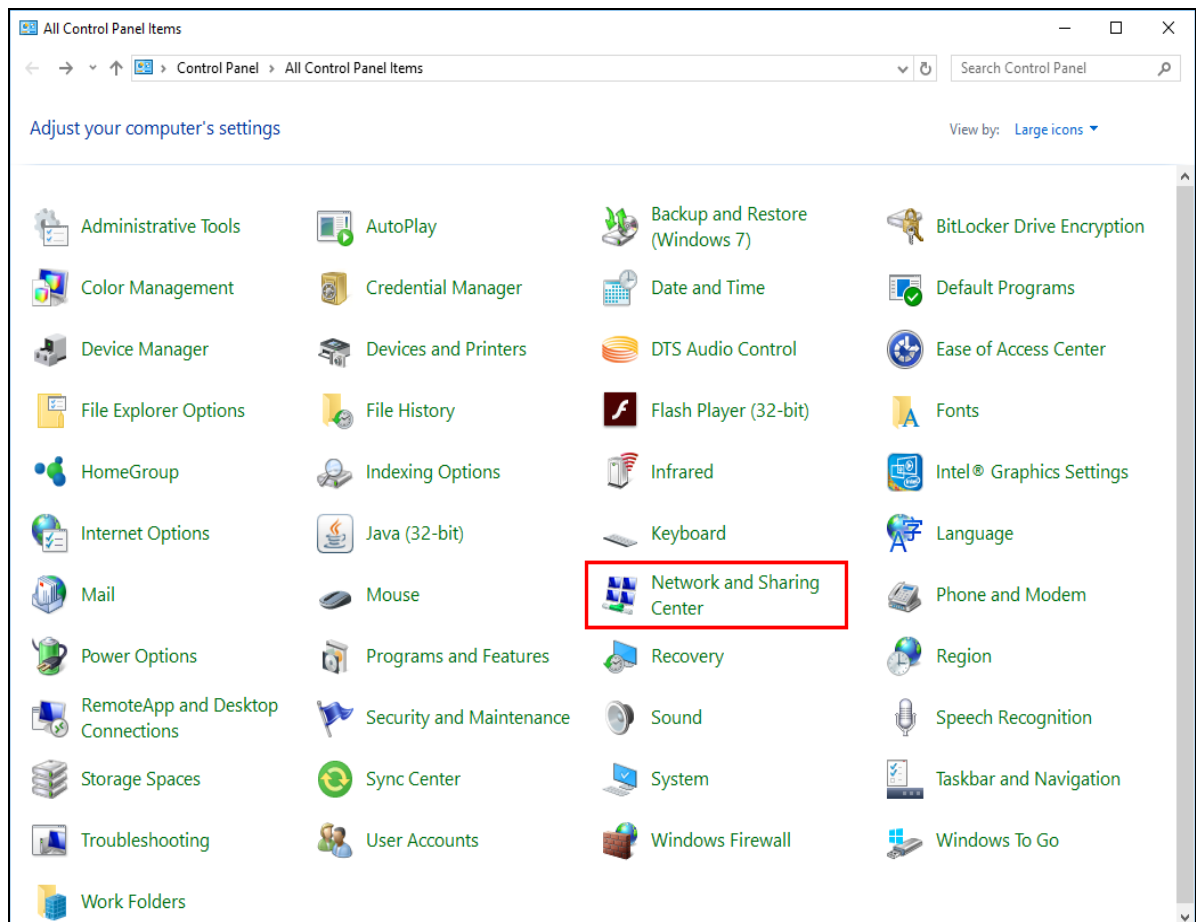

- 2 Click **Change Advanced Sharing Settings**.

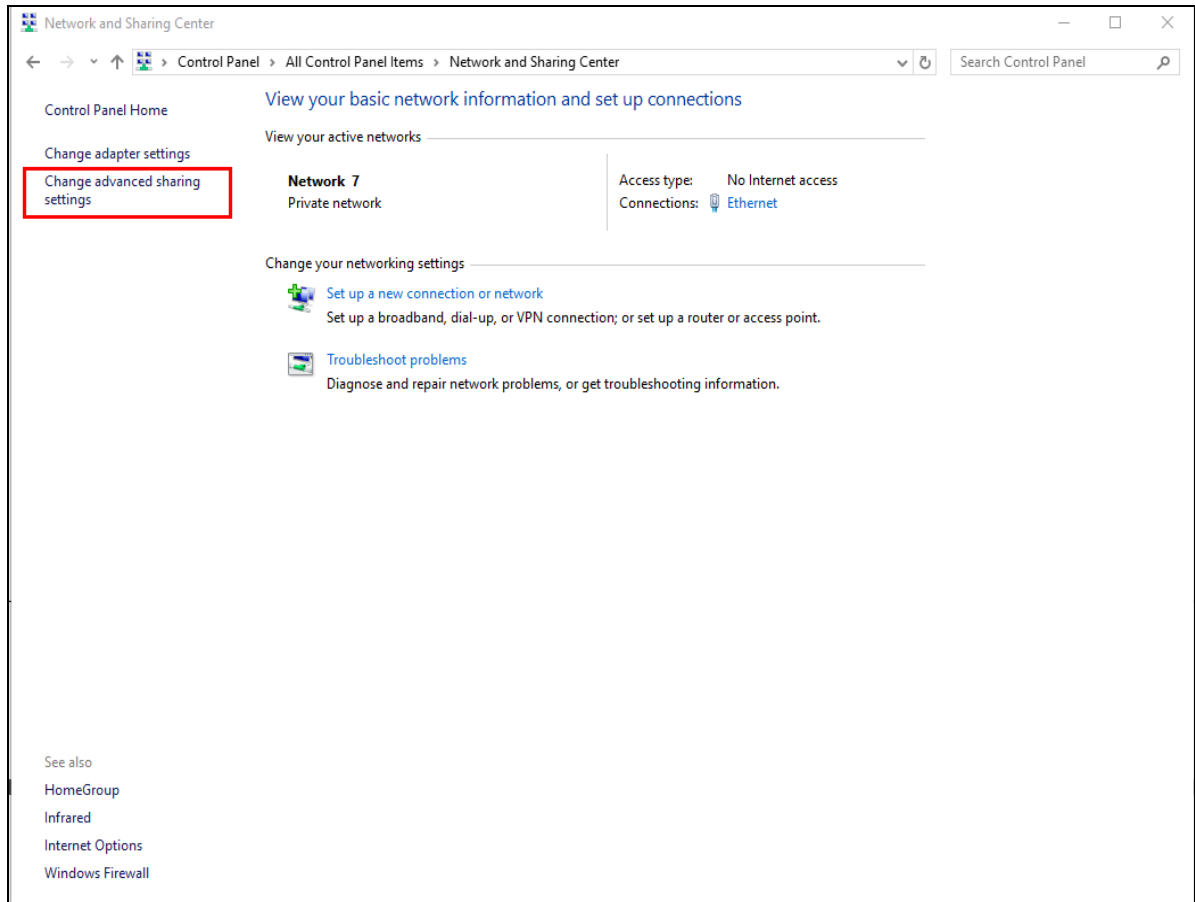

- 3 Select **Turn on network discovery** and click **Save Changes**. Network discovery allows your computer to find other computers and devices on the network and other computers on the network to find your computer. This makes it easier to share files and printers.

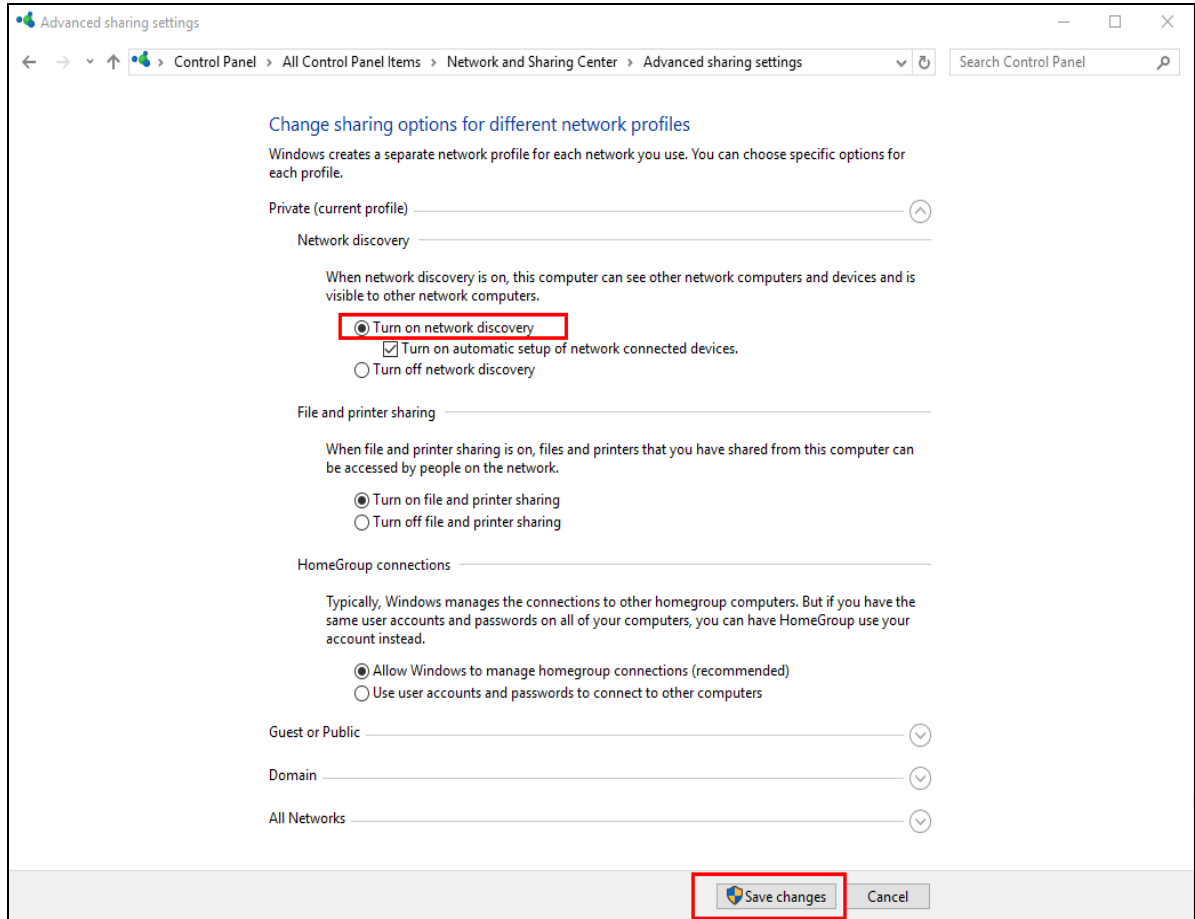

9.9.2 Turning on UPnP in Windows 10 Example

This section shows you how to use the UPnP feature in Windows 10. UPnP server is installed in Windows 10. Activate UPnP on the NBG6818 in **Settings > Internet > UPnP**.

Make sure the computer is connected to the LAN port of the NBG6818. Turn on your computer and the NBG6818.

- 1 Click the start icon, **Settings** and then **Network & Internet**.

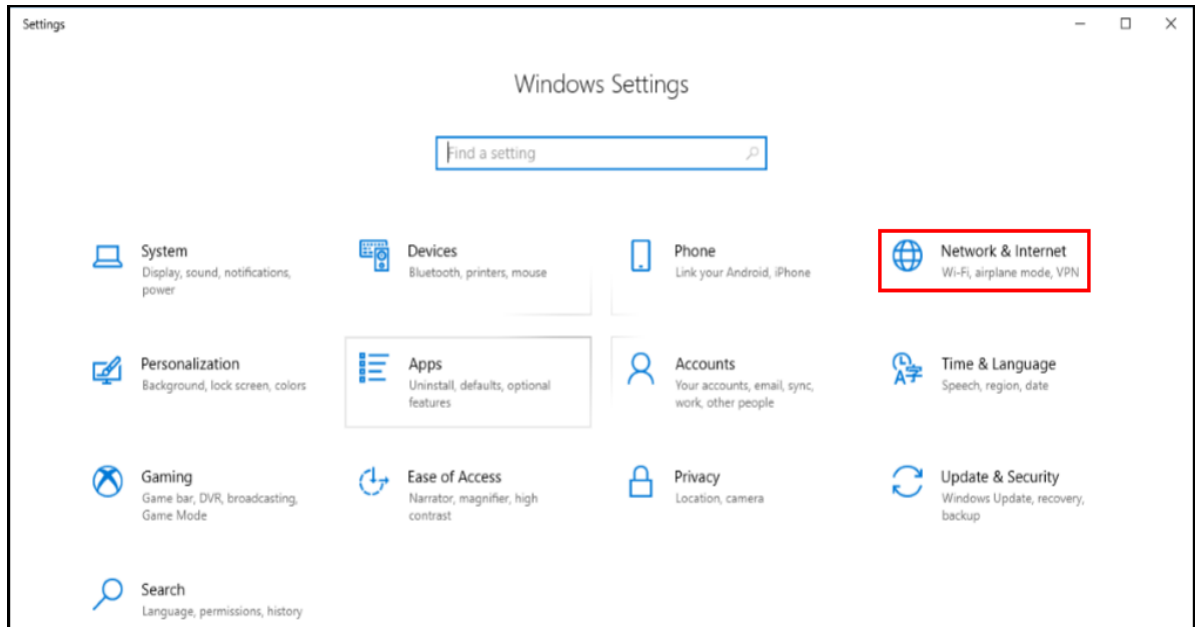

- 2 Click Network and Sharing Center.

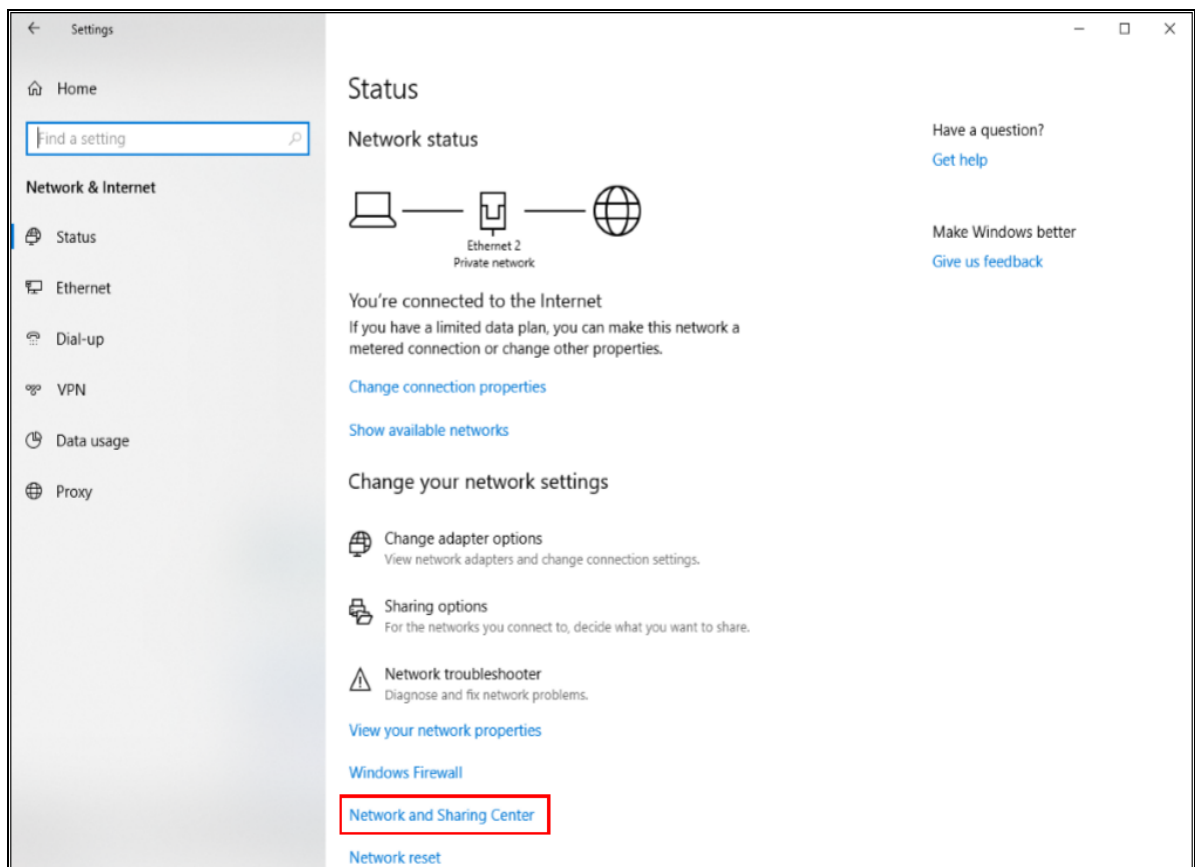

- 3 Click Change advanced sharing settings.

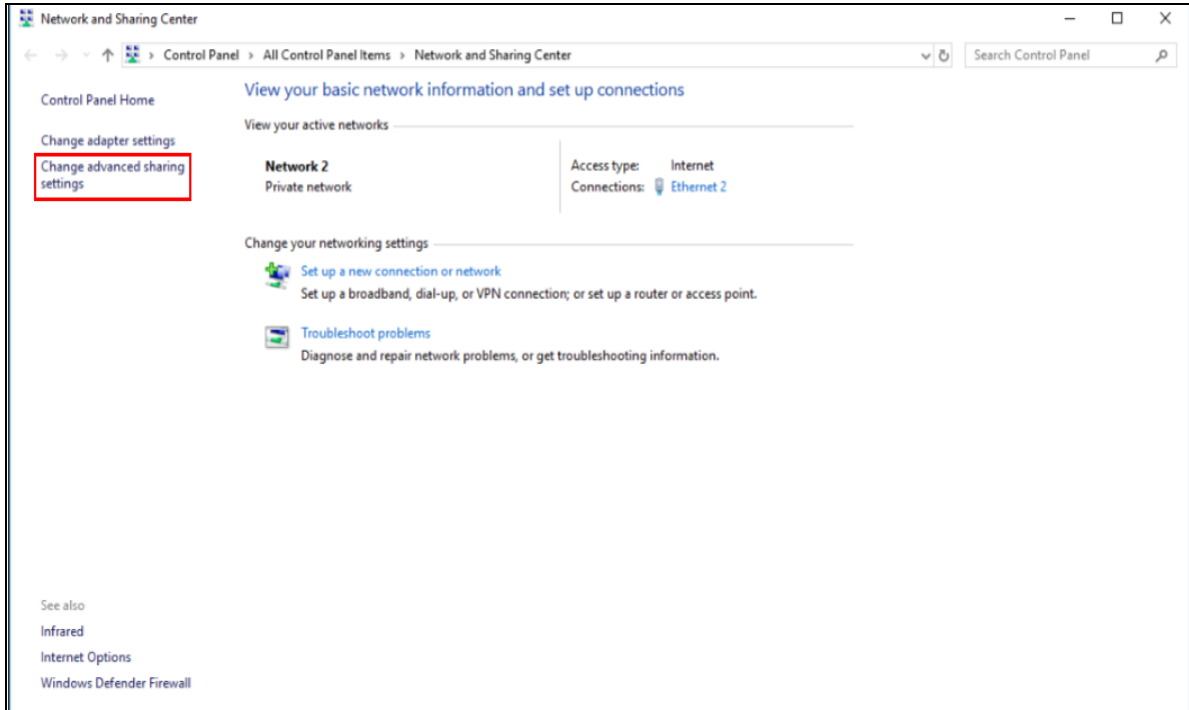

- 4 Under **Domain**, select **Turn on network discovery** and click **Save Changes**. Network discovery allows your computer to find other computers and devices on the network and other computers on the network to find your computer. This makes it easier to share files and printers

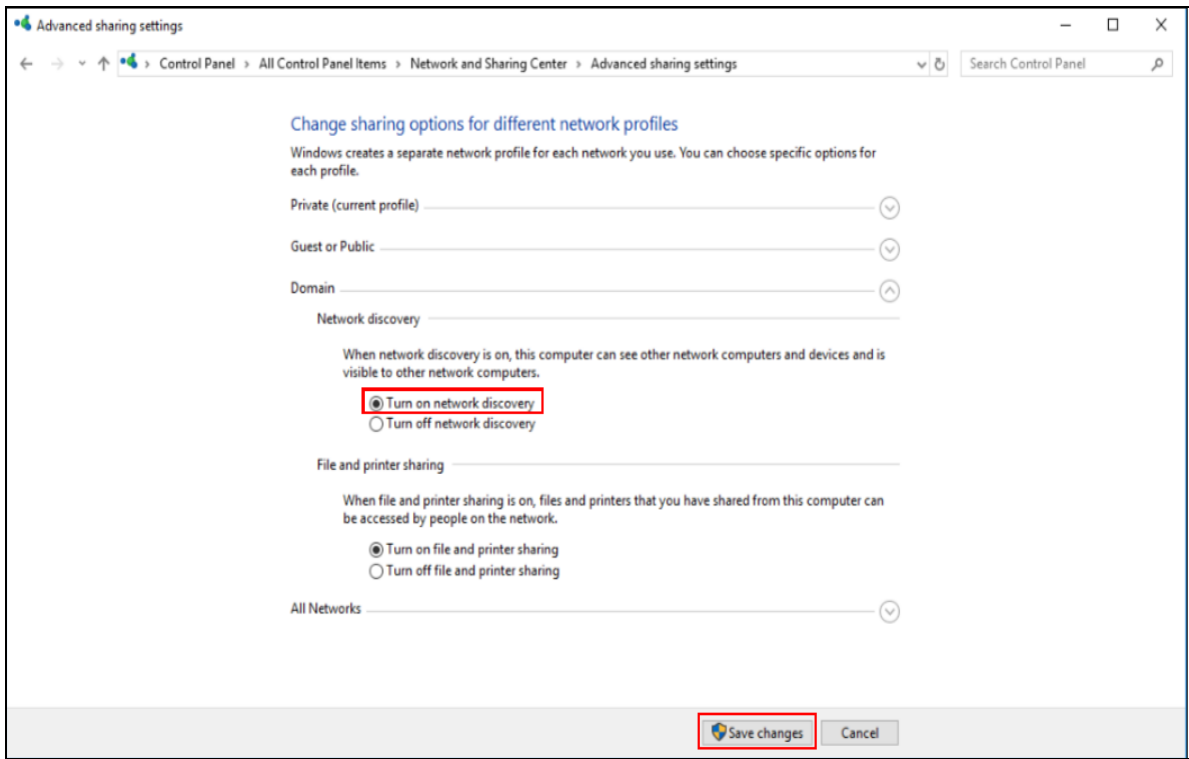

CHAPTER 10

Wireless LAN

10.1 Overview

This chapter discusses how to configure the wireless network settings in your NBG6818. The NBG6818 can service both 2.4GHz and 5GHz networks at the same time. You can have different wireless setup and settings for 2.4GHz and 5GHz wireless LANs. Click **Settings > WiFi** to configure **wireless LAN 2.4G** or **wireless LAN 5G**.

See the appendices for more detailed information about wireless networks.

The following figure provides an example of a wireless network.

Figure 54 Example of a Wireless Network

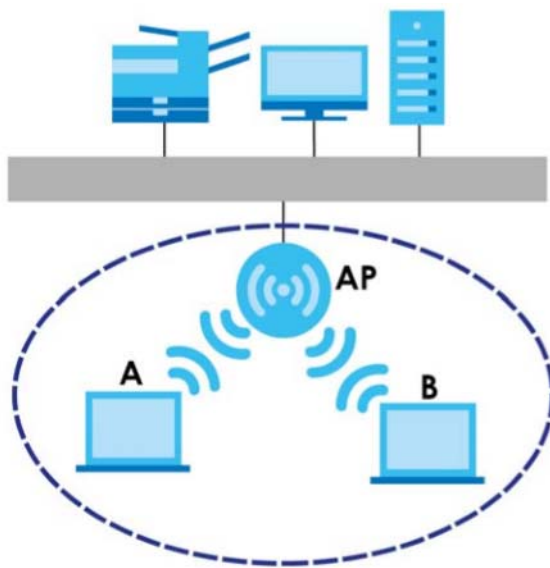

The wireless network in the figure is encircled in blue. In this wireless network, devices **A** and **B** are called wireless clients. The wireless clients use the access point (AP) to interact with other devices (such as the printer) or with the Internet. Your NBG6818 is the AP.

10.1.1 What You Can Do

- Use the **Main WiFi** screen to enable or disable the 2.4GHz or 5GHz wireless LAN, set up wireless security between the NBG6818 and the wireless clients, and make other basic configuration changes ([Section 10.2 on page 106](#)).
- Use the **Guest WiFi** screen to set up multiple wireless networks on your NBG6818 ([Section 10.3 on page 108](#)).
- Use the **MAC Filter** screen to allow or deny wireless stations from connecting to the NBG6818 based on their MAC address ([Section 10.4 on page 108](#)).

- Use the **WPS** screen to quickly set up a wireless network with strong security without having to configure security settings manually ([Section 10.5 on page 110](#)).
- Use the **Scheduling** screen to set the times your wireless LAN is turned on and off ([Section 10.6 on page 112](#)).

10.1.2 What You Should Know

Every wireless network must follow these basic guidelines.

- Every wireless client in the same wireless network must use the same Service Set Identifier (SSID).
The SSID is the name of the wireless network.
- If two wireless networks overlap, they should use different channels.
Like radio stations or television channels, each wireless network uses a specific channel, or frequency, to send and receive information.
- Every wireless client in the same wireless network must use security compatible with the AP.
Security stops unauthorized devices from using the wireless network. It also protects information that is sent through the wireless network.

Wireless Security Overview

The following sections introduce different types of wireless security you can set up in the wireless network.

SSID

Normally, the AP acts like a beacon and regularly broadcasts the SSID in the area. You can hide the SSID instead, in which case the AP does not broadcast the SSID. In addition, you should change the default SSID to something that is difficult to guess.

This type of security is fairly weak, however, because there are ways for unauthorized devices to get the SSID. In addition, unauthorized devices can still see the information that is sent in the wireless network.

MAC Address Filter

Every wireless client has a unique identification number, called a MAC address.¹ A MAC address is usually written using twelve hexadecimal characters²; for example, 00A0C5000002 or 00:A0:C5:00:00:02. To get the MAC address for each wireless client, see the appropriate User's Guide or other documentation.

You can use the MAC address filter to tell the AP which wireless clients are allowed or not allowed to use the wireless network. If a wireless client is allowed to use the wireless network, it still has to have the correct settings (SSID, channel, and security). If a wireless client is not allowed to use the wireless network, it does not matter if it has the correct settings.

This type of security does not protect the information that is sent in the wireless network. Furthermore, there are ways for unauthorized devices to get the MAC address of an authorized wireless client. Then, they can use that MAC address to use the wireless network.

1. Some wireless devices, such as scanners, can detect wireless networks but cannot use wireless networks. These kinds of wireless devices might not have MAC addresses.
2. Hexadecimal characters are 0, 1, 2, 3, 4, 5, 6, 7, 8, 9, A, B, C, D, E, and F.

User Authentication

You can make every user log in to the wireless network before they can use it. This is called user authentication. However, every wireless client in the wireless network has to support IEEE 802.1x to do this.

For wireless networks, there are two typical places to store the user names and passwords for each user.

- In the AP: this feature is called a local user database or a local database.
- In a RADIUS server: this is a server used in businesses more than in homes.

If your AP does not provide a local user database and if you do not have a RADIUS server, you cannot set up user names and passwords for your users.

Unauthorized devices can still see the information that is sent in the wireless network, even if they cannot use the wireless network. Furthermore, there are ways for unauthorized wireless users to get a valid user name and password. Then, they can use that user name and password to use the wireless network.

Local user databases also have an additional limitation that is explained in the next section.

Encryption

Wireless networks can use encryption to protect the information that is sent in the wireless network. Encryption is like a secret code. If you do not know the secret code, you cannot understand the message.

The WPA-PSK (WiFi Protected Access-Pre-Shared Key) security mode provides both improved data encryption and user authentication over WEP. Using a pre-shared key, both the Zyxel Device and the connecting client share a common password in order to validate the connection. This type of encryption, while robust, is not as strong as WPA, WPA2 or even WPA2-PSK. The WPA2-PSK security mode is a more robust version of the WPA encryption standard. It offers slightly better security, although the use of PSK makes it less robust than it could be. The WPA3-SAE (Simultaneous Authentication of Equals handshake) is the newer security mode that protects against dictionary attacks by implementing a new key exchange protocol.

Guest WLAN

Guest WLAN allows you to set up a wireless network where users can access to Internet via the NBG6818 (Z), but not other networks connected to it. In the following figure, a guest user can access the Internet from the guest wireless network **A** via **Z** but not the home or company network **N**.

Note: The home or company network **N** and Guest WLAN network are independent networks.

Note: Only Standard Mode supports guest WLAN.

Figure 55 Guest Wireless LAN Network

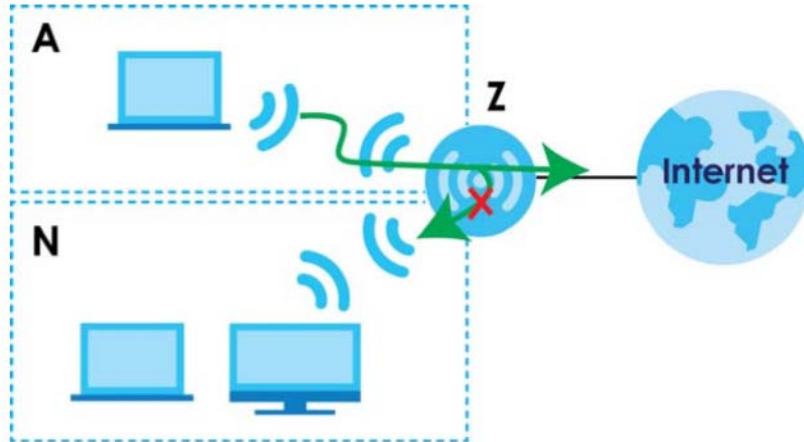

Guest WLAN Bandwidth

The Guest WLAN Bandwidth function allows you to restrict the maximum bandwidth for the guest wireless network. Additionally, you can also define bandwidth for your home or office network. An example is shown in the next figure to define maximum bandwidth for your networks (A is Guest WLAN and N is a home or company network.)

Figure 56 Example: Bandwidth for Different Networks

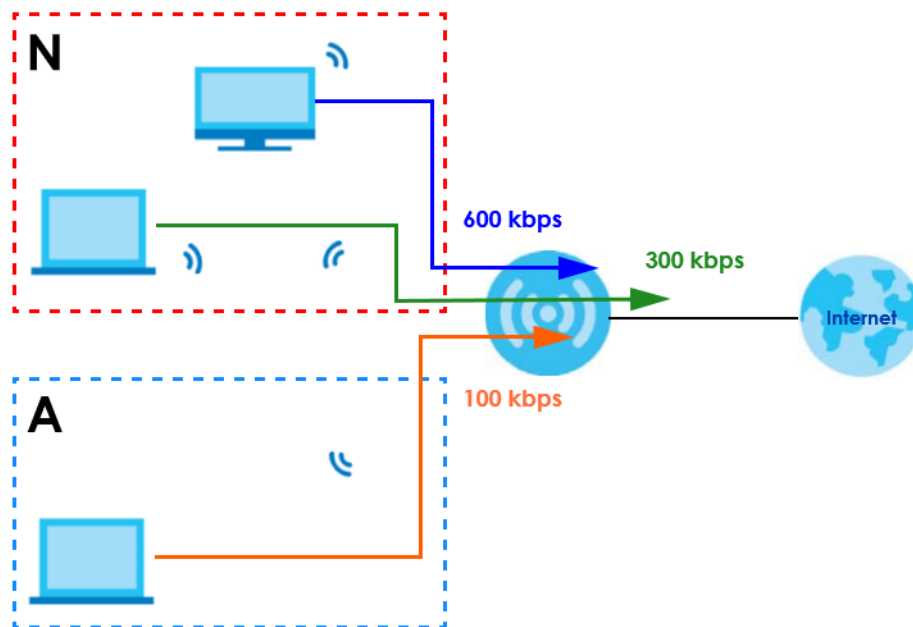

WPS

WiFi Protected Setup (WPS) is an industry standard specification defined by the WiFi Alliance. WPS allows you to set up a wireless network with strong security without having to configure security settings manually. Depending on the devices in your network, you can either press a button (on the device itself, or in its configuration utility) or enter a PIN (Personal Identification Number) in the devices. They then connect and set up a secure network by themselves. See how to set up a secure wireless network using WPS in [Section 7.2 on page 42](#).

10.2 Main WiFi Screen

Use this screen to configure the SSID and wireless security of the NBG6818's default wireless LAN.

Note: If you are configuring the NBG6818 from a computer connected to the wireless LAN and you change the NBG6818's SSID, channel or security settings, you will lose your wireless connection when you press **Apply** to confirm. You must then change the wireless settings of your computer to match the NBG6818's new settings.

Click **Settings > WiFi > Main WiFi** to show the following screen.

Figure 57 Settings > WiFi > Main WiFi (Standard Mode)

The screenshot shows the 'Main WiFi' settings screen. The title is 'Main WiFi'. The settings are as follows:



- Enable Main WiFi: Enable Disable
- Name (SSID): NBG6818_TW
- Keep 2.4G & 5G name the same:
- Security Mode: WPA2-PSK WPA3-PSK WPA3-PSK Mix
- Password: [Redacted]
- Region: US
- 2.4G Bandwidth: 40
- 2.4G Channel: Auto (Channel: 11)
- 5G Bandwidth: 80
- 5G Channel: Auto (Channel: 36)

At the bottom right, there are two buttons: CANCEL and APPLY.

Figure 58 Settings > WiFi > Main WiFi (Bridge Mode)

The following table describes the labels in this screen.

Table 32 Settings > WiFi > Main WiFi

LABEL	DESCRIPTION
Main WiFi	
Enable Main WiFi	Select Enable to activate the 2.4GHz and/or 5GHz wireless LAN. Select Disable to turn it off.
2.4G/5G Name (SSID)	The Service Set Identity (SSID) identifies the wireless LAN with which a wireless client is associated. Enter a name (up to 32 printable characters found on a typical English language keyboard) for the wireless LAN. Click the Keep 2.4G & 5G name the same check box to use the same SSID for 2.4G and 5G wireless network.
Security Mode	Select the security mode you want to apply to the NBG6818.
Password	The password has two uses: <ul style="list-style-type: none"> Manual: Manually enter the same password on the Zyxel Device and the client. Enter 8-63 ASCII characters or exactly 64 hexadecimal ('0-9', 'a-f') characters. WPS: When using WPS, the Zyxel Device sends this password to the client. Click the eye icon  to show or hide the password of your wireless network. When the eye icon is slashed  , you'll see the password in plain text. Otherwise, it is hidden.
Region	The country is set to US by default.
2.4G/5G Bandwidth	Select a bandwidth from the drop-down list box. The options vary depending on the frequency band you want to apply to the NBG6818.
2.4G/5G Channel	Select a channel from the drop-down list box. The options vary depending on the frequency band you want to apply to the NBG6818.
Apply	Click Apply to save your changes back to the NBG6818.
Cancel	Click Cancel to reload the previous configuration for this screen.

10.3 Guest WiFi Screen

This screen allows you to enable and configure guest wireless network settings on the NBG6818.



Click **Settings** > **WiFi** > **Guest WiFi** to show the following screen.

Note: This is not available if you are using bridge mode.

Figure 59 Settings > WiFi > Guest WiFi

The following table describes the labels in this screen.

Table 33 Settings > WiFi > Guest WiFi

LABEL	DESCRIPTION
Enable Guest WiFi	Select Enable to activate the guest WiFi. Select Disable to turn it off.
Name (SSID)	An SSID profile is the set of parameters relating to one of the NBG6818's BSSs. The SSID (Service Set Identifier) identifies the Service Set with which a wireless device is associated. This field displays the name of the wireless profile on the network. When a wireless client scans for an AP to associate with, this is the name that is broadcast and seen in the wireless client utility.
Password	The password has two uses. <ul style="list-style-type: none"> Manual: Manually enter the same password on the Zyxel Device and the client. Enter 8-63 ASCII characters or exactly 64 hexadecimal ('0-9', 'a-f') characters. WPS: When using WPS, the Zyxel Device sends this password to the client. Click the Eye icon  to show or hide the password of your wireless network. When the Eye icon is slashed  , you'll see the password in plain text. Otherwise, it is hidden.
Apply	Click Apply to save your changes back to the NBG6818.
Cancel	Click Cancel to reload the previous configuration for this screen.

10.4 MAC Filter Screen

The MAC filter screen allows you to give exclusive access to devices (**Allow**) or exclude devices from accessing the NBG6818 (**Deny**). Every Ethernet device has a unique MAC (Media Access Control) address. The MAC address is assigned at the factory and consists of six pairs of hexadecimal characters,

for example, 00:A0:C5:00:00:02. You need to know the MAC address of the devices to configure this screen.

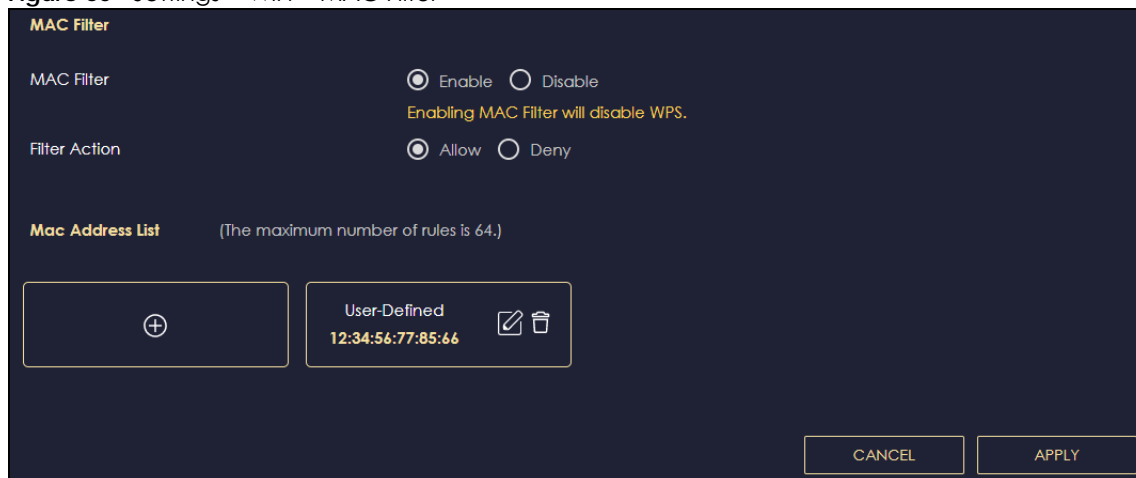

Use this screen to change your NBG6818's MAC filter settings. Click **Settings > WiFi > MAC Filter** to show following screen.

Figure 60 Settings > WiFi > MAC Filter



The following table describes the labels in this screen.

Table 34 Settings > WiFi > MAC Filter

LABEL	DESCRIPTION
MAC Filter	Select to turn on (Enable) or off (Disable) MAC address filtering.
Filter Action	Define the filter action for the list of MAC addresses in the MAC Filter Summary table. Select Allow to permit access to the NBG6818. MAC addresses not listed will be denied access to the NBG6818. Select Deny to block access to the NBG6818. MAC addresses not listed will be allowed to access the NBG6818.
MAC Address List (Max Limit : 64)	
	This field displays the MAC address of the wireless station you want to filter. Click  to configure the MAC address. Click  to delete the MAC address.
Add	Click  to add a rule in the MAC Address List .
Apply	Click Apply to save your changes back to the NBG6818.
Cancel	Click Cancel to reload the previous configuration for this screen.

10.4.1 Add MAC Address Screen

Use this screen to configure the MAC address you want to add to the MAC address list. Click **Settings > WiFi > MAC Filter > Add** to show the following screen.

Figure 61 Settings > WiFi > MAC Filter > Add

The following table describes the labels in this screen.

Table 35 Settings > WiFi > MAC Filter > Add

LABEL	DESCRIPTION
Type	This field displays the MAC address of the wireless station. If you select User-Defined , enter the MAC address(es) manually.
MAC Address	Enter a MAC address manually in this field if you select User-Defined in the Type field.
Apply	Click Apply to save your changes back to the NBG6818.
Cancel	Click Cancel to exist this screen without saving.

10.5 WPS Screen

Use this screen to enable/disable WPS, view or generate a new PIN and check the current WPS status. Click **Settings > WiFi > WPS** to show the following screen.

Note: With WPS, wireless clients can only connect to the wireless network using the first SSID on the NBG6818.

Figure 62 Settings > WiFi > WPS

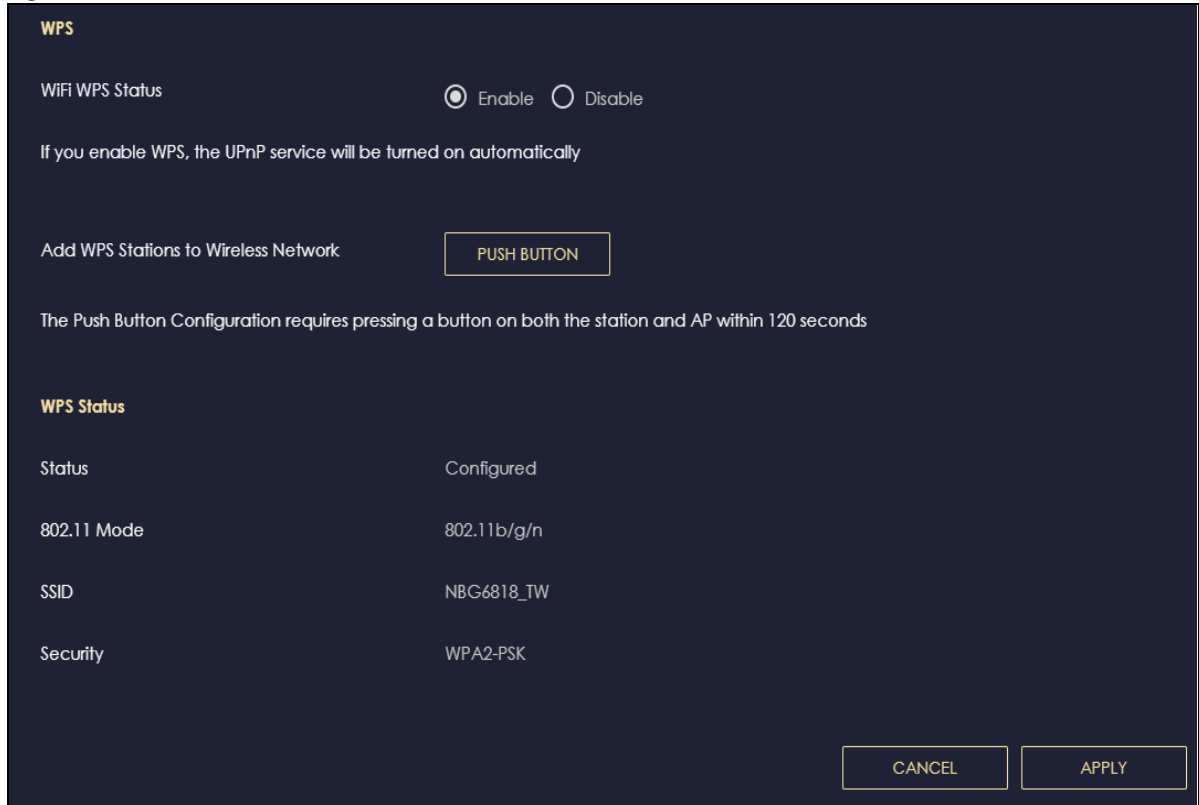

The following table describes the labels in this screen.

Table 36 Settings > WiFi > WPS

LABEL	DESCRIPTION
WPS	
WiFi WPS Status	Select Enable to turn on the WPS feature. Otherwise, select Disable .
Push Button	Use this button when you use the PBC (Push Button Configuration) method. Click this to start WPS-aware wireless station scanning and wireless security information synchronization.
WPS Status	
Status	This displays Configured when a wireless station has connected to the NBG6818 using WPS and wireless setup or security settings have been changed from default. The current wireless setup and security settings also appear in this screen. This displays Unconfigured if WPS is disabled and there are no wireless setup or security changes on the NBG6818 or if you click Release Configuration to restore wireless setup and security settings to default.
802.11 Mode	This is the 802.11 mode used. Only compliant WLAN devices can associate with the NBG6818.
SSID	This is the name of the wireless network (the NBG6818's first SSID) that WPS clients connect to.
Security	This is the type of wireless security employed by the network.
Apply	Click Apply to save your changes back to the NBG6818.
Cancel	Click Cancel to reload the previous configuration for this screen.

10.6 Scheduling Screen

Use this screen to set the times your wireless LAN is turned on and off. Wireless LAN scheduling is disabled by default. The wireless LAN can be scheduled to turn on or off on certain days and at certain times. The y-axis shows the time period in days. The x-axis shows the time period in hours. Click on the boxes to select the time period.

Click **Settings > WiFi > Scheduling** to show the following screen.

Figure 63 Settings > WiFi > Scheduling

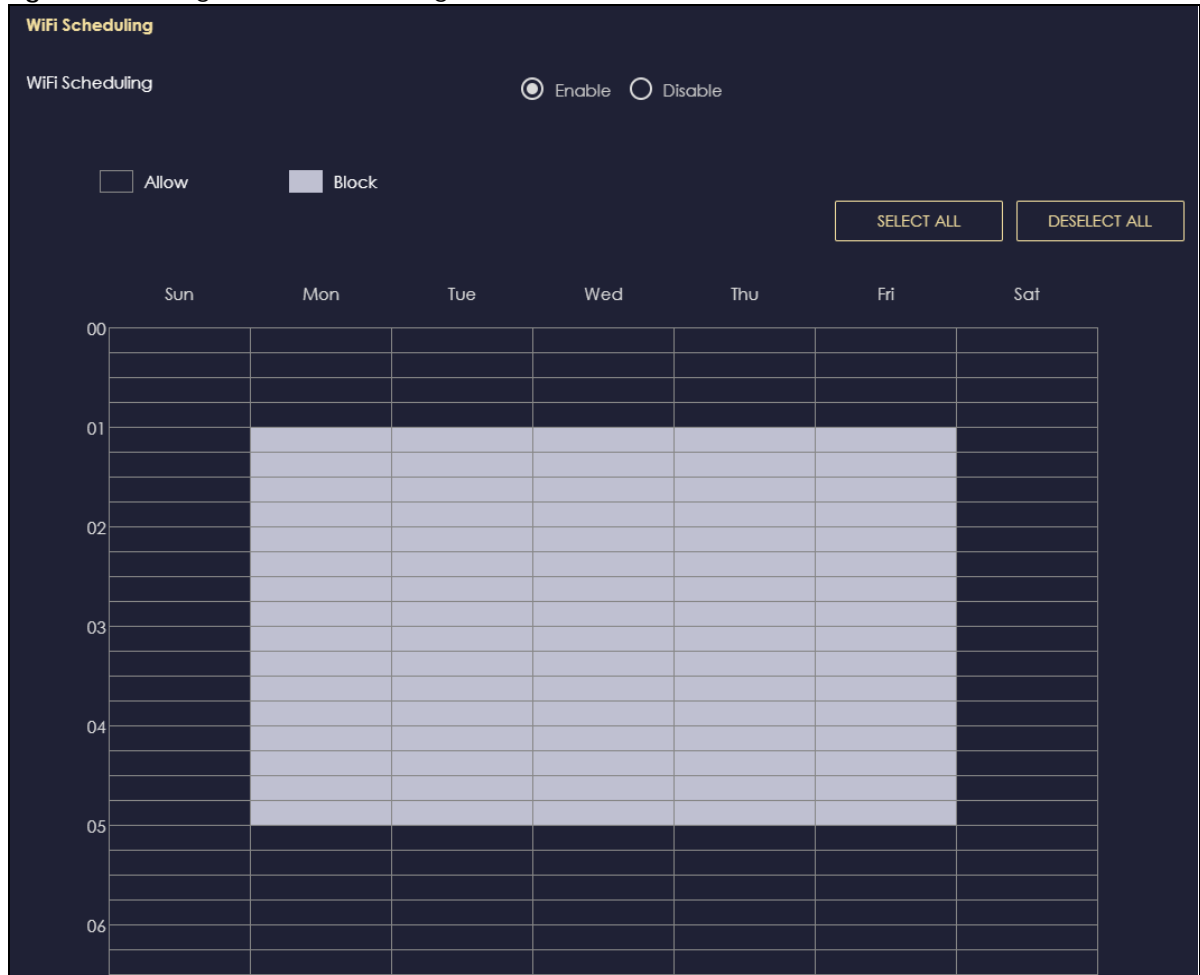

The following table describes the labels in this screen.

Table 37 Expert Mode > Wireless > Scheduling

LABEL	DESCRIPTION
WiFi Scheduling	Select Enable to activate the wireless LAN scheduling feature. Select Disable to turn it off.
Select All	Click Select All or click gray blocks to specify days and times to turn the Wireless LAN on or off. If you click Select All you can not select any specific days and times.
Deselect All	Click Deselect All to remove all the wireless LAN scheduling.
Apply	Click Apply to save your changes back to the NBG6818.
Cancel	Click Cancel to reload the previous configuration for this screen.

CHAPTER 11

LAN

11.1 Overview

This chapter describes how to configure LAN settings.

A Local Area Network (LAN) is a shared communication system to which many computers are connected. A LAN is a computer network limited to the immediate area, usually the same building or floor of a building.

Figure 64 LAN Example

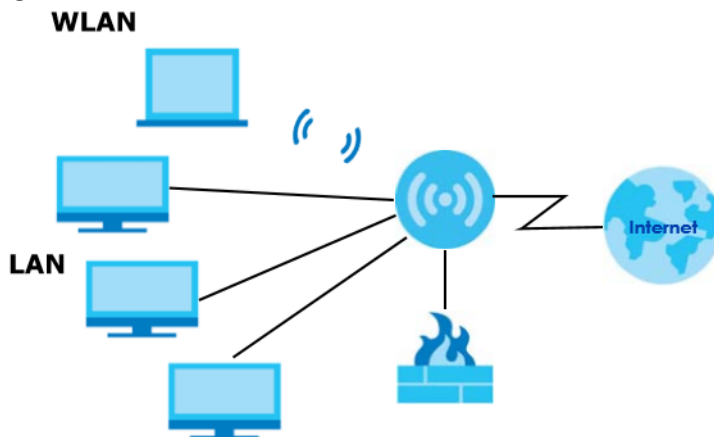

The LAN screens can help you configure a manage IP addresses and partition your physical network into logical networks.

11.2 What You Can Do

- Use the **LAN IP** screen to configure the IP addresses for your NBG6818 on the LAN ([Section 11.4 on page 114](#)).
- Use the **IPv6 LAN** screen to configure the IPv6 address for your NBG6818 on the LAN ([Section 11.5 on page 120](#)).

11.3 What You Need To Know

The actual physical connection determines whether the NBG6818 ports are LAN or WAN ports. There are two separate IP networks: one inside the LAN network and the other outside the WAN network as shown in the following figure.

Figure 65 LAN and WAN IP Addresses

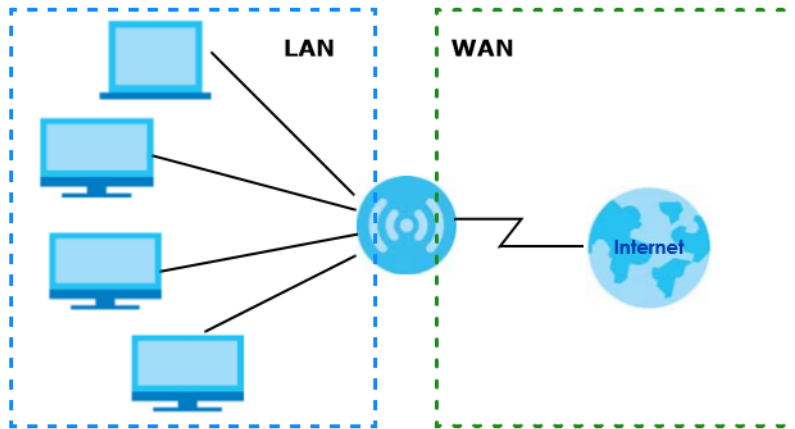

The LAN parameters of the NBG6818 are preset in the factory with the following values:

- IPv4 address of 192.168.123.1 with subnet mask of 255.255.255.0 (24 bits)
- DHCP server enabled with 128 client IPv4 addresses starting from 192.168.123.33.

These parameters should work for the majority of installations.

11.4 LAN IP Screen

Use this screen to change the IP address for your NBG6818 in Standard Mode. Click **Settings** > **LAN** > **LAN IP** to show the following screen.

Figure 66 Settings > LAN > LAN IP (Standard Mode)

LAN IP Rule

IP Address

IP Subnet Mask

DHCP Server

DHCP Server Enable Disable

IP Pool Starting Address

DHCP Pool Size

DNS Server

DNS Servers Assigned by DHCP Server

First DNS Server

Second DNS Server

Third DNS Server

Static DHCP Table (The maximum number of rules is 64.) + Add Rule

No.	Name	MAC Address	IP Address	Actions
1		34:64:A9:27:D6:42	172.21.40.6	
2	TWNBNT02231-02	F0:76:1C:73:D1:CA	192.168.123.143	

Figure 67 Settings > LAN > LAN IP (Bridge Mode)

LAN IP Rule

IP Address setting

Obtain an IP Address Automatically(DHCP)

Static IP Address

IP Address

IP Subnet Mask

Gateway

DNS Server

First DNS Server

Second DNS Server



Third DNS Server

The following table describes the labels in this screen.

Table 38 Settings > LAN > LAN IP

LABEL	DESCRIPTION
LAN IP Rule	
IP Address	Type the IP address of your NBG6818 in dotted decimal notation.
IP Subnet Mask	The subnet mask specifies the network number portion of an IP address. Your NBG6818 will automatically calculate the subnet mask based on the IP address that you assign. Unless you are implementing subnetting, use the subnet mask computed by the NBG6818.
DHCP Server	
Note: This is not available if you are using bridge mode.	
DHCP Server	Select Enable to activate DHCP for LAN. Select Disable to stop the NBG6818 from acting as a DHCP server. DHCP (Dynamic Host Configuration Protocol, RFC 2131 and RFC 2132) allows individual clients (computers) to obtain TCP/IP configuration at startup from a server. Enable the DHCP server unless your ISP instructs you to do otherwise. When configured as a server, the NBG6818 provides TCP/IP configuration for the clients. If not, DHCP service is disabled and you must have another DHCP server on your LAN, or else the computers must be manually configured. When set as a server, fill in the following four fields.
IP Pool Starting Address	This field specifies the first of the contiguous addresses in the IP address pool for LAN.

Table 38 Settings > LAN > LAN IP (continued)

LABEL	DESCRIPTION
DHCP Pool Size	This field specifies the size, or count of the IP address pool for LAN.
DNS Server	
DNS Servers Assigned by DHCP Server	
First DNS Server	Select Obtained From ISP if your ISP dynamically assigns DNS server information (and the NBG6818's WAN IP address). The field to the right displays the (read-only) DNS server IP address that the ISP assigns.
Second DNS Server	
Third DNS Server	
	Select User-Defined if you have the IP address of a DNS server. Enter the DNS server's IP address in the field to the right.
	Select LAN IP and the field to the right displays the (read-only) default gateway IP address of your computer.
	Select None if you do not want to configure DNS servers. If you do not configure a DNS server, you must know the IP address of a computer in order to access it.
Static DHCP Table	
Note: This is not available if you are using bridge mode.	
No.	This is the index number of the static IP table entry (row).
Name	This field displays a name to identify this rule.
MAC Address	This field displays the MAC address of a computer on your LAN, or the MAC address you manually configured.
IP Address	This field displays the LAN IP address of a computer on your LAN, or the LAN address you manually configured.
Actions	Click the icons under Actions to delete or edit an existing static IP. Click  to delete an existing static IP. Click  to edit an existing static IP.
Apply	Click Apply to save your changes back to the NBG6818.
Cancel	Click Cancel to begin configuring this screen afresh.

11.4.1 Static DHCP Table-Add/Edit Rule Screen

Use this screen to configure the static DHCP. Click **Settings > LAN > LAN IP > Add Rule** or **Settings > LAN > LAN IP > Edit** to show the following screens.

Note: This is not available if you are using bridge mode.

Figure 68 Settings > LAN > LAN IP > Add Rule

Static DHCP Table - Add Rule

Device List: User-Defined

MAC Address: [Empty]

IP Address: [Empty]

CANCEL APPLY

Figure 69 Settings > LAN > LAN IP > Edit

Static DHCP Table - Edit Rule

Device List: [Dropdown]

MAC Address: 34:64:A9:27:D6:42

IP Address: 172.21.40.6

CANCEL APPLY

The following table describes the labels in these screens.

Table 39 Settings > LAN > LAN IP > Add Rule/Edit

LABEL	DESCRIPTION
Device List	This field lists the system name of the LAN user device which is connected to the NBG6818 and assigned an IP address. Select a LAN user device from the list to automatically detect the MAC address of a computer on your LAN. Otherwise, select User-Defined to enter the MAC address of a computer on your LAN in the MAC Address field.
MAC Address	This field displays the MAC address of a computer on your LAN. If you select User-Defined in the Device List field, enter the MAC address(es) manually.
IP Address	This field displays the IP address of a computer on your LAN. If you select User-Defined in the Device List field, enter the IP address(es) manually.
Apply	Click Apply to save your changes back to the NBG6818.
Cancel	Click Cancel to exit this screen without saving.

11.4.2 Configure LAN Screen in Bridge Mode

Use this section to configure your LAN settings while in **Bridge Mode**.

Click **Settings > LAN > LAN IP** to show the following screen.

Note: If you change the IP address of the NBG6818 in the screen below, you will need to log into the NBG6818 again using the new IP address.

Figure 70 Settings > LAN > LAN IP

The screenshot displays the 'LAN IP Rule' configuration screen. It is organized into two main sections: 'IP Address setting' and 'DNS Server'. In the 'IP Address setting' section, there are two radio buttons: 'Obtain an IP Address Automatically(DHCP)' (which is selected) and 'Static IP Address'. Below these are three input fields for 'IP Address', 'IP Subnet Mask', and 'Gateway'. The 'DNS Server' section contains three rows, each with a dropdown menu and an adjacent input field. The 'First DNS Server' and 'Second DNS Server' dropdowns are set to 'Obtained From ISP', while the 'Third DNS Server' dropdown is set to 'None'. At the bottom right, there are two buttons: 'CANCEL' and 'APPLY'.

The table below describes the labels in the screen.

Table 40 Settings > LAN > LAN IP

LABEL	DESCRIPTION
IP Address setting	
Obtain an IP Address Automatically (DHCP)	<p>When you enable this, the NBG6818 gets its IP address from the network's DHCP server (for example, your ISP). Users connected to the NBG6818 can now access the network (i.e., the Internet if the IP address is given by the ISP).</p> <p>The Web Configurator may no longer be accessible unless you know the IP address assigned by the DHCP server to the NBG6818. You need to reset the NBG6818 to be able to access the Web Configurator again (see Section 13.6 on page 136 for details on how to reset the NBG6818).</p> <p>Also when you select this, you cannot enter an IP address for your NBG6818 in the field below.</p>
Static IP Address	Click this if you want to specify the IP address of your NBG6818. Or if your ISP or network administrator gave you a static IP address to access the network or the Internet.
IP Address	Type the IP address in dotted decimal notation. The default setting is 192.168.1.2. If you change the IP address you will have to log in again with the new IP address.
Subnet Mask	The subnet mask specifies the network number portion of an IP address. Your NBG6818 will automatically calculate the subnet mask based on the IP address that you assign. Unless you are implementing subnetting, use the subnet mask computed by the NBG6818.
Gateway	Enter a gateway IP address (if your ISP or network administrator gave you one) in this field.
DNS Server	
First DNS Server Second DNS Server Third DNS Server	<p>Select Obtained From ISP if your ISP dynamically assigns DNS server information (and the NBG6818's WAN IP address). The field to the right displays the (read-only) DNS server IP address that the ISP assigns.</p> <p>Select User-Defined if you have the IP address of a DNS server. Enter the DNS server's IP address in the field to the right. If you chose User-Defined, but leave the IP address set to 0.0.0.0, User-Defined changes to None after you click Apply. If you set a second choice to User-Defined, and enter the same IP address, the second User-Defined changes to None after you click Apply.</p> <p>Select None if you do not want to configure DNS servers. If you do not configure a DNS server, you must know the IP address of a computer in order to access it.</p>
Apply	Click Apply to save your changes to the NBG6818.
Cancel	Click Cancel to reload the previous configuration for this screen.

11.5 IPv6 LAN Screen

Use this screen to configure the IP address for your NBG6818 on the LAN. Click **Settings > LAN > IPv6 LAN** to show the following screen.

Note: This is not available if you are using bridge mode.

Figure 71 Settings > LAN > IPv6 LAN

The following table describes the labels in this screen.

Table 41 Settings > Expert Mode > LAN > IPv6 LAN

LABEL	DESCRIPTION
LAN IPv6 Address Assignment	
Enable_DHCPv6-PD	Select this option to use DHCPv6 prefix delegation. The NBG6818 will obtain an IPv6 prefix from the ISP or a connected uplink router for the LAN.
Autoconfiguration Type	Select SLAAC + RDNSS to enable IPv6 stateless auto-configuration on this interface. The interface will generate an IPv6 IP address itself from a prefix obtained from an IPv6 router in the network. Select SLAAC + Stateless DHCPv6 to enable IPv6 stateless auto-configuration on this interface. The interface will get an IPv6 address from an IPv6 router and the DHCP server. The IP address information gets through DHCPv6. Select Stateful DHCPv6 to allow a DHCP server to assign and pass IPv6 network addresses, prefixes and other configuration information to DHCP clients.
IPv6 Address range (Start)	Enter the beginning of the range of IP addresses that this address object represents.

Table 41 Settings > Expert Mode > LAN > IPv6 LAN (continued)

LABEL	DESCRIPTION
IPv6 Address range (End)	Enter the end of the range of IP address that this address object represents.
IPv6 Lifetime	Enter the IPv6 lifetime in the LAN.
Static IP Address Select this option to manually enter an IPv6 address if you want to use a static IP address.	
LAN IPv6 Address	Enter the LAN IPv6 address you want to assign to your NBG6818 in hexadecimal notation.
LAN IPv6 Routeinfo Length (48~64)	Enter the 48 to 64 address prefix length to specify in an IPv6 address compose the network address.
Prefix Valid Lifetime	Enter the valid lifetime for the prefix.
Link Local Only Select this option to only use the link local address on the NBG6818 interfaces in the LAN.	
ULA Select this option to identify a unique local address of the NBG6818 in the LAN.	
RA period	
Minimum RA period	Enter the minimum time in seconds between router advertisement messages.
Apply	Click Apply to save your changes back to the NBG6818.
Cancel	Click Cancel to begin configuring this screen afresh.

CHAPTER 12

Security

12.1 Overview

Use these screens to enable and configure the firewall that protects your NBG6818 and your LAN from unwanted or malicious traffic.

Enable the firewall to protect your LAN computers from attacks by hackers on the Internet and control access between the LAN and WAN. By default the firewall:

- allows traffic that originates from your LAN computers to go to all of the networks.
- blocks traffic that originates on the other networks from going to the LAN.

The following figure illustrates the default firewall action. User **A** can initiate an IM (Instant Messaging) session from the LAN to the WAN (1). Return traffic for this session is also allowed (2). However other traffic initiated from the WAN is blocked (3 and 4).

Figure 72 Default Firewall Action

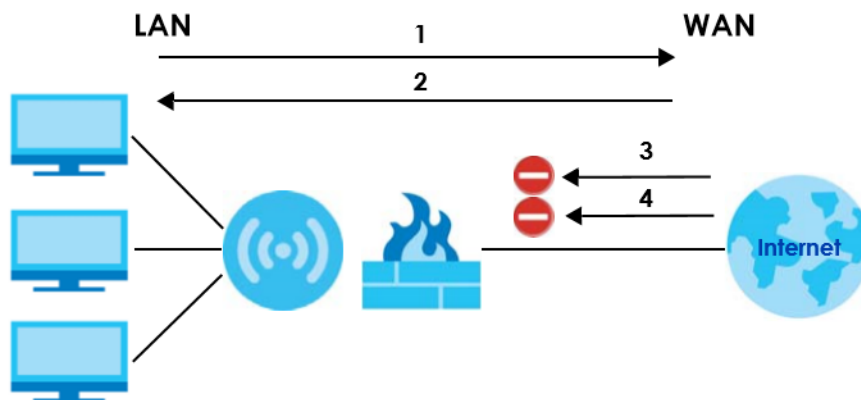

Note: Features in this chapter are not available if you are using bridge mode.

12.1.1 What You Can Do

- Use the **IPv4 Firewall** screen to enable or disable the NBG6818's IPv4 firewall ([Section 12.2 on page 124](#)).
- Use the **IPv6 Firewall** screen to enable or disable the NBG6818's IPv6 firewall ([Section 12.3 on page 127](#)).

12.1.2 What You Need To Know

The following terms and concepts may help as you read through this chapter.

About the NBG6818 Firewall

The NBG6818's firewall feature physically separates the LAN and the WAN and acts as a secure gateway for all data passing between the networks.

It is a stateful inspection firewall and is designed to protect against Denial of Service attacks when activated (click the **IPv4 Firewall** or **IPv6 Firewall** tab under **Security** and then click the **Enable Firewall** check box). The NBG6818's purpose is to allow a private Local Area Network (LAN) to be securely connected to the Internet. The NBG6818 can be used to prevent theft, destruction and modification of data, as well as log events, which may be important to the security of your network.

The NBG6818 is installed between the LAN and a broadband modem connecting to the Internet. This allows it to act as a secure gateway for all data passing between the Internet and the LAN.

The NBG6818 has one Ethernet WAN port and four Ethernet LAN ports, which are used to physically separate the network into two areas. The WAN (Wide Area Network) port attaches to the broadband (cable or DSL) modem to the Internet.

The LAN (Local Area Network) port attaches to a network of computers, which needs security from the outside world. These computers will have access to Internet services such as e-mail, FTP and the World Wide Web. However, "inbound access" is not allowed (by default) unless the remote host is authorized to use a specific service.

Guidelines For Enhancing Security With Your Firewall

- 1 Change the default password via Web Configurator.
- 2 Think about access control before you connect to the network in any way, including attaching a modem to the port.
- 3 Limit who can access your router.
- 4 Don't enable any local service (such as NTP) that you don't use. Any enabled service could present a potential security risk. A determined hacker might be able to find creative ways to misuse the enabled services to access the firewall or the network.
- 5 For local services that are enabled, protect against misuse. Protect by configuring the services to communicate only with specific peers, and protect by configuring rules to block packets for the services at specific interfaces.
- 6 Protect against IP spoofing by making sure the firewall is active.
- 7 Keep the firewall in a secured (locked) room.

12.2 IPv4 Firewall Screen

Use this screen to enable or disable the NBG6818's IPv4 firewall. Click **Settings > Firewall > IPv4 Firewall** to show the following screen.

Figure 73 Settings > Firewall > IPv4 Firewall

ICMP

Respond Ping LAN WAN WAN & LAN None

Firewall Setup

Enable Firewall Enable Disable

Enable Firewall Rule

Filter Rule Enable Disable

Actions Drop Accept

Firewall Rule (The maximum number of rules is 64.) + Add Rule



No.	Service Name	MAC Address	Dest IP Address	Source IP Address	Dest Port Range	Source Port Range	Protocol	Actions
CANCEL APPLY								

The following table describes the labels in this screen.

Table 42 Settings > Firewall > IPv4 Firewall

LABEL	DESCRIPTION
ICMP	Internet Control Message Protocol is a message control and error-reporting protocol between a host server and a gateway to the Internet. ICMP uses Internet Protocol (IP) datagrams, but the messages are processed by the TCP/IP software and directly apparent to the application user.
Respond to Ping on	The NBG6818 will not respond to any incoming Ping requests when None is selected. Select LAN to reply to incoming LAN Ping requests. Select WAN to reply to incoming WAN Ping requests. Otherwise select LAN&WAN to reply to all incoming LAN and WAN Ping requests.
Firewall Setup	
Enable Firewall	Select Enable to activate the firewall. The NBG6818 performs access control and protects against Denial of Service (DoS) attacks when the firewall is activated.
Enable Firewall Rule	
Filter Rule	Select Enable to activate the firewall rules that you define (see Add Firewall Rule below).
Actions	Select Drop to silently discard the packets which meet the firewall rules. The others are accepted. Select Accept to allow the passage of the packets which meet the firewall rules. The others are blocked.
Firewall Rule	
No.	This is your firewall rule number. The ordering of your rules is important as rules are applied in turn.
Service Name	This is a name that identifies or describes the firewall rule.
MAC address	This is the MAC address of the computer for which the firewall rule applies.

Table 42 Settings > Firewall > IPv4 Firewall (continued)

LABEL	DESCRIPTION
Dest IP Address	This is the IP address of the computer to which traffic for the application or service is entering.
Source IP Address	This is the IP address of the computer from which traffic for the application or service is initialized.
Dest Port Range	This is the port number/range of the destination that define the traffic type, for example TCP port 80 defines web traffic.
Source Port Range	This is the port number/range of the source that define the traffic type, for example TCP port 80 defines web traffic.
Protocol	This is the protocol (TCP , UDP or ICMP) used to transport the packets for which you want to apply the firewall rule.
Actions	Click  to remove the firewall rule. Click  to edit the firewall rule.
Apply	Click Apply to save the settings.
Cancel	Click Cancel to start configuring this screen again.

12.2.1 IPv4 Firewall-Add Rule Screen

Use this screen to configure IPv4 firewall rule. Click **Settings > Firewall > IPv4 Firewall > Add Rule** to open the following screen.

Figure 74 Settings > Firewall > IPv4 Firewall > Add Rule

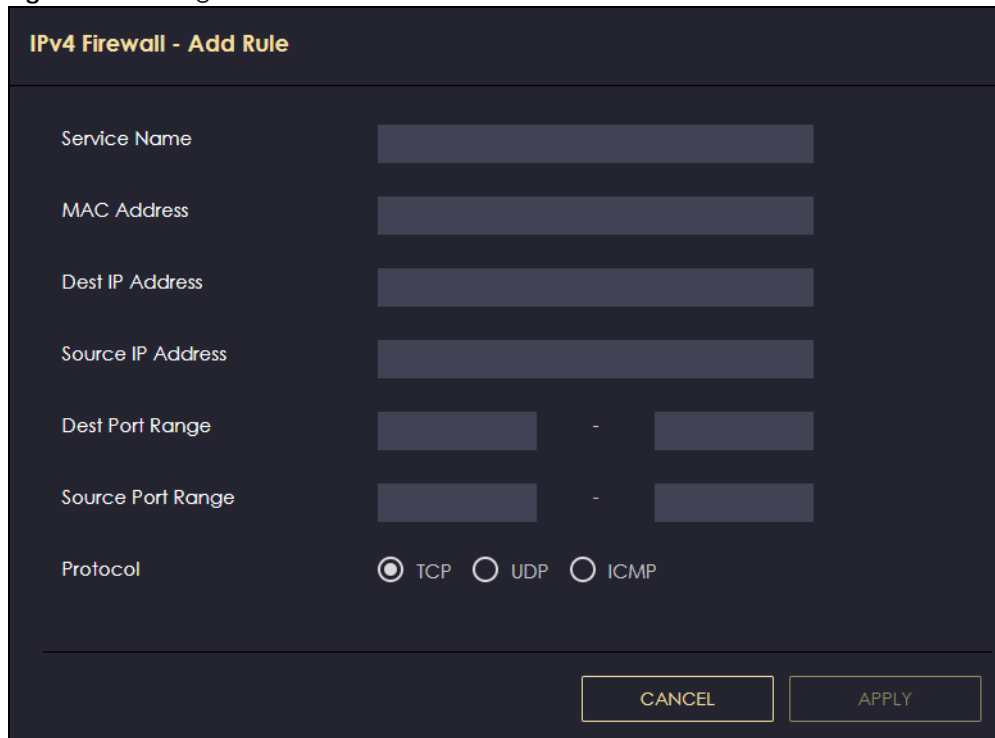

IPv4 Firewall - Add Rule

Service Name

MAC Address

Dest IP Address

Source IP Address

Dest Port Range -

Source Port Range -

Protocol TCP UDP ICMP

The following table describes the labels in this screen.

Table 43 Settings > Firewall > IPv4 Firewall > Add Rule

LABEL	DESCRIPTION
Service Name	Enter a name that identifies or describes the firewall rule.
MAC Address	Enter the MAC address of the computer for which the firewall rule applies.
Dest IP Address	Enter the IP address of the computer to which traffic for the application or service is entering. The NBG6818 applies the firewall rule to traffic initiating from this computer.
Source IP Address	Enter the IP address of the computer that initializes traffic for the application or service. The NBG6818 applies the firewall rule to traffic initiating from this computer.
Dest Port Range	This is the port number/range of the destination that define the traffic type, for example TCP port 80 defines web traffic.
Source Port Range	This is the port number/range of the source that define the traffic type, for example TCP port 80 defines web traffic.
Protocol	Select the protocol (TCP , UDP or ICMP) used to transport the packets for which you want to apply the firewall rule.
Apply	Click Apply to save the settings.
Cancel	Click Cancel to exist this screen without saving.

12.3 IPv6 Firewall Screen

Use this screen to enable and create IPv6 firewall rules to filter IPv6 traffic. Click **Settings > Firewall > IPv6 Firewall** to show the following screen.

Figure 75 Settings > Firewall > IPv6 Firewall

Configuration

Simple Security Enable Disable

Rule Status Enable Disable

Actions Drop Accept



Firewall Rule (The maximum number of rules is 64.) + Add Rule

No.	Service Name	MAC Address	Dest IP Address	Source IP Address	Dest Port Range	Source Port Range	Protocol	Actions

CANCEL APPLY

The following table describes the labels in this screen.

Table 44 Settings > Firewall > IPv6 Firewall

LABEL	DESCRIPTION
Configuration	
Simple Security	Select Enable to enabled simple security on your NBG6818.
Rule Status	Select Enable to enabled rule status on your NBG6818.
Action	Select DROP to silently discard the packets which meet the firewall rules. The others are accepted. Select ACCEPT to allow the passage of the packets which meet the firewall rules. The others are blocked.
Firewall Rule	
No.	This is your firewall rule number. The ordering of your rules is important as rules are applied in turn.
Service Name	This is a name that identifies or describes the firewall rule.
MAC Address	This is the MAC address of the computer for which the firewall rule applies.
Dest IP Address	This is the IP address of the computer to which traffic for the application or service is entering.
Source IP Address	This is the IP address of the computer to which traffic for the application or service is initialized.
Dest Port Range	This is the port number/range of the destination that defines the traffic type, for example TCP port 80 defines web traffic.
Source Port Range	This is the port number/range of the source that defines the traffic type, for example TCP port 80 defines web traffic.
Protocol	This is the protocol (TCP , UDP or ICMPv6) used to transport the packets for which you want to apply the firewall rule.
Actions	Click  to remove the firewall rule. Click  to edit the firewall rule.
Apply	Click Apply to save the settings.
Cancel	Click Cancel to restore your previously saved settings.

12.3.1 IPv6 Firewall-Add Rule Screen

Use this screen to configure IPv4 firewall rule. Click **Settings > Firewall > IPv6 Firewall > Add Rule** to open the following screen.

Figure 76 Settings > Firewall > IPv6 Firewall > Add Rule

IPv6 Firewall - Add Rule

Service Name

MAC Address

Dest IP Address

Source IP Address

Dest Port Range -

Source Port Range -

Protocol TCP UDP ICMPv6

The following table describes the labels in this screen.

Table 45 Settings > Firewall > IPv4 Firewall > Add Rule

LABEL	DESCRIPTION
Service Name	Enter a name that identifies or describes the firewall rule.
MAC Address	Enter the MAC address of the computer for which the firewall rule applies.
Dest IP Address	Enter the IP address of the computer to which traffic for the application or service is entering. The NBG6818 applies the firewall rule to traffic initiating from this computer.
Source IP Address	Enter the IP address of the computer that initializes traffic for the application or service. The NBG6818 applies the firewall rule to traffic initiating from this computer.
Dest Port Range	This is the port number/range of the destination that define the traffic type, for example TCP port 80 defines web traffic.
Source Port Range	This is the port number/range of the source that define the traffic type, for example TCP port 80 defines web traffic.
Protocol	Select the protocol (TCP , UDP or ICMP) used to transport the packets for which you want to apply the firewall rule.
Apply	Click Apply to save the settings.
Cancel	Click Cancel to exist this screen without saving.

CHAPTER 13

System

13.1 Overview

This chapter provides information on checking the NBG6818's status and logs, configuring basic and remote management settings, using maintenance and firmware upgrade tools, and changing the operating mode.

13.2 What You Can Do

- Use the **Status** screen to view the basic information of the NBG6818 ([Section 13.3 on page 130](#))
- Use the **General Setting** screen to change password or to set the timeout period of the management session ([Section 13.4 on page 133](#)).
- Use the **Remote Access** screen to configure the interface/s from which the NBG6818 can be managed remotely and specify a secure client that can manage the NBG6818 ([Section 13.5 on page 135](#)).
- Use the **Maintenance** screen to upload firmware, reboot the NBG6818 without turning the power off or reset the NBG6818 to factory defaults ([Section 13.6 on page 136](#)).
- Use the **Operating Mode** screen select whether you want the NBG6818 to act as a router or a bridge ([Section 13.7 on page 137](#)).
- Use the **Logs** screen to see the system logs recorded by the NBG6818 ([Section 13.8 on page 139](#)).

13.3 Status Screen

Use this screen to view some basic information of your NBG6818. Click **Settings > System > Status** to show the following screen.

Figure 77 Settings > System > Status (Standard Mode)



The screenshot displays the 'System Status' page for the NBG6818 device. It is organized into three main sections: System, WAN Information, and LAN Information. Each section lists various configuration parameters and their current values.

System	
Model Name	NBG6818
Firmware Version	V1.00(ABSC.0)b4_fw
System Operation Mode	Standard Mode
Enable IPv4 Firewall	Enable
Enable IPv6 Simple Security	Enable
System Uptime	4 Days 5 Hours 28 Minutes 19 Second

WAN Information	
MAC Address	B8:EC:A3:F5:A7:19
IP Address	
IP Subnet Mask	
Gateway	
IPv6 Address	

LAN Information	
MAC Address	B8:EC:A3:F5:A7:18
IP Address	192.168.123.1
IP Subnet Mask	255.255.255.0
DHCP Server	Enable
IPv6 Address	

Figure 78 Settings > System > Status (Bridge Mode)

System	
Model Name	NBG6818
Firmware Version	V1.00{ABSC.1}B1
System Operation Mode	Bridge Mode
Enable IPv4 Firewall	Enable
Enable IPv6 Simple Security	Enable
System Uptime	0 Days 21 Hours 8 Minutes 50 Second
LAN Information	
MAC Address	
IP Address	
IP Subnet Mask	
DHCP Server	Enable
IPv6 Address	

The following table describes the labels in this screen.

Table 46 Settings > System > Status

LABEL	DESCRIPTION
System	
Model Name	This is the model name of your device.
Firmware Version	This is the firmware version.
System Operation Mode	This is the device mode in which the NBG6818 is currently running. See Section 13.7 on page 137 for more information.
Enable IPv4 Firewall	This shows if the IPv4 firewall is enabled on the NBG6818.
Enable IPv6 Simple Security	This shows if the IPv6 firewall is enabled on the NBG6818.
System Uptime	This is the total time the NBG6818 has been on.
WAN Information	
Note: : This is not available if you are using bridge mode.	
MAC Address	This shows the WAN Ethernet adapter MAC Address of your device.
IP Address	This shows the NBG6818's WAN IP address.
IP Subnet Mask	This shows the NBG6818's WAN subnet mask.
Gateway	This shows the WAN port's gateway IP address.
IPv6 Address	This shows the current IPv6 address of the NBG6818.
LAN Information	
MAC Address	This shows the LAN Ethernet adapter MAC Address of your device.
IP Address	This shows the NBG6818's LAN IP address.
IP Subnet Mask	This shows the NBG6818's LAN subnet mask.

Table 46 Settings > System > Status (continued)

LABEL	DESCRIPTION
DHCP Server	This shows whether the NBG6818 acts as a DHCP Server and provides LAN IP addresses to its clients or not.
IPv6 Address	This shows the current LAN IPv6 address of the NBG6818.

13.4 General Setting Screen

Use this screen to set the management session timeout period. Click **Settings > System > General Setting** to show the following screen.

Figure 79 Settings > System > General Setting (Standard Mode)

System Settings

System Name: NBG6818

Domain Name:

Admin Inactivity Timer: 3600

Select Language: Auto

Admin Password

Current password:

New Password:

Confirm New Password:

CANCEL APPLY

Figure 80 Settings > System > General Setting (Bridge Mode)

System Settings

System Name: NBG6818

Admin Inactivity Timer: 9999

Select Language: Auto

Admin Password

Current password: [Redacted] [Eye icon]

New Password: [Redacted] [Eye icon]

Confirm New Password: [Redacted] [Eye icon]

CANCEL APPLY

The following table describes the labels in this screen.

Table 47 Settings > System > General Setting

LABEL	DESCRIPTION
System Settings	
System Name	System Name is a unique name to identify the NBG6818 in an Ethernet network.
Domain Name (This is not available if you are using bridge mode)	Enter the domain name you want to give to the NBG6818.
Admin Inactivity Timer	Type how many minutes a management session can be left idle before the session times out. The default is 5 minutes. After it times out, you have to log in with your password again. Very long idle timeouts may have security risks. A value of "0" means a management session never times out, no matter how long it has been left idle (not recommended).
Select Language	Select a language you prefer from the drop-down list box. The Web Configurator language changes after a while without restarting the NBG6818.
Admin Password	
Current Password	Type the default password or the existing password you use to access the system in this field.
New Password	Type your new system password (up to 30 characters). Note that as you type a password, the screen displays a dot for each character you type.
Confirm New Password	Type the new password again in this field.
Apply	Click Apply to save your changes back to the NBG6818.
Cancel	Click Cancel to discard all changes.

13.5 Remote Access Screen

Use this screen to change your NBG6818's remote management settings. You can use HTTPS or Wake on LAN to access and manage the NBG6818.

Wake On LAN (WoL) allows you to remotely turn on a device on the network, such as a computer, storage device or media server. To use this feature, the remote hardware (such as the network adapter on a computer) must support Wake On LAN using the "Magic Packet" method.

You need to know the MAC address of the remote client to use this feature. It may be on a label on the device.

Click **Settings > System > Remote Access** to show the following screen.

Note: You can only enable **Remote Assistant** in this screen if you are using bridge mode.

Figure 81 Settings > System > Remote Access (Standard Mode)

The screenshot shows the Remote Access settings screen for NBG6818 in Standard Mode. The screen is dark-themed and contains the following sections and controls:

- HTTPS**
 - Server Port: 443
 - Access Interface: LAN
- Remote Assistance**
 - Enable Remote Assistant: Enable Disable
- Wake On LAN**
 - Wake On LAN Status: Enable Disable
 - Port: 9
 - Wake On LAN Mac Address: User-Defined

At the bottom of the screen, there are three buttons: **START**, **CANCEL**, and **APPLY**.

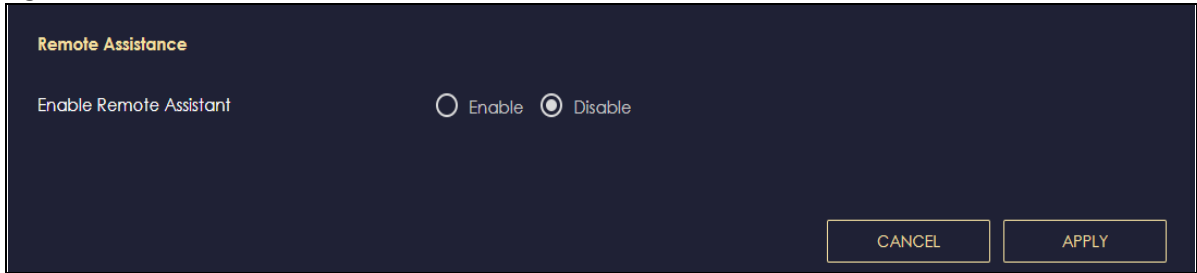
Figure 82 Settings > System > Remote Access (Bridge Mode)

The following table describes the labels in this screen.

Table 48 Settings > System > Remote Access

LABEL	DESCRIPTION
HTTPS	
Server Port	You may change the server port number for a service if needed, however you must use the same port number in order to use that service for remote management.
Access Interface	Select the interface(s) through which a computer may access the NBG6818 using this service.
Remote Assistance	
Enable Remote Assistant	Select Enable to allow customer support to help you solve the problems you encounter with your NBG6818 remotely.
Wake on LAN	
Wake on LAN Status	Select Enable to have the NBG6818 forward a WoL "Magic Packet" to all devices on the LAN if the packet comes from the WAN or remote network and uses the port number specified in the Port field. A LAN device whose hardware supports Wake on LAN then will be powered on if it is turned off previously.
Port	Type a port number from which a WoL packet is forwarded to the LAN.
Wake on LAN MAC Address	This field displays the hostname and MAC address of the LAN device by default. Otherwise, select User-Defined to enter the MAC Address of the device on the network that will be turned on. A MAC address consists of six hexadecimal character pairs.
Start	Click this to have the NBG6818 generate a WoL packet and forward it to turn the specified device on. A screen pops up displaying MAC address error if you input the MAC address incorrectly.
Apply	Click Apply to save your changes back to the NBG6818.
Cancel	Click Cancel to begin configuring this screen afresh.

13.6 Maintenance Screen

Use this screen to upgrade firmware, restart or reset your NBG6818.

Online Firmware

Find firmware at www.zyxel.com in a file that uses the version number and project code with a "*.bin" extension, e.g., "V1.00(ABCS.0)C0.bin". The upload process uses HTTP (Hypertext Transfer Protocol) and may take up to two minutes. After a successful upload, the system will reboot.

System Restart

System restart allows you to reboot the NBG6818 without turning the power off.

Reset to Factory Default

Click the **RESET TO FACTORY DEFAULT** button in this section to clear all user-entered configuration information and returns the NBG6818 to its factory defaults.

You can also press the **RESET** button on the rear panel to reset the factory defaults of your NBG6818.

Click **Settings > System > Maintenance** to show the following screen.

Figure 83 Settings > System > Maintenance

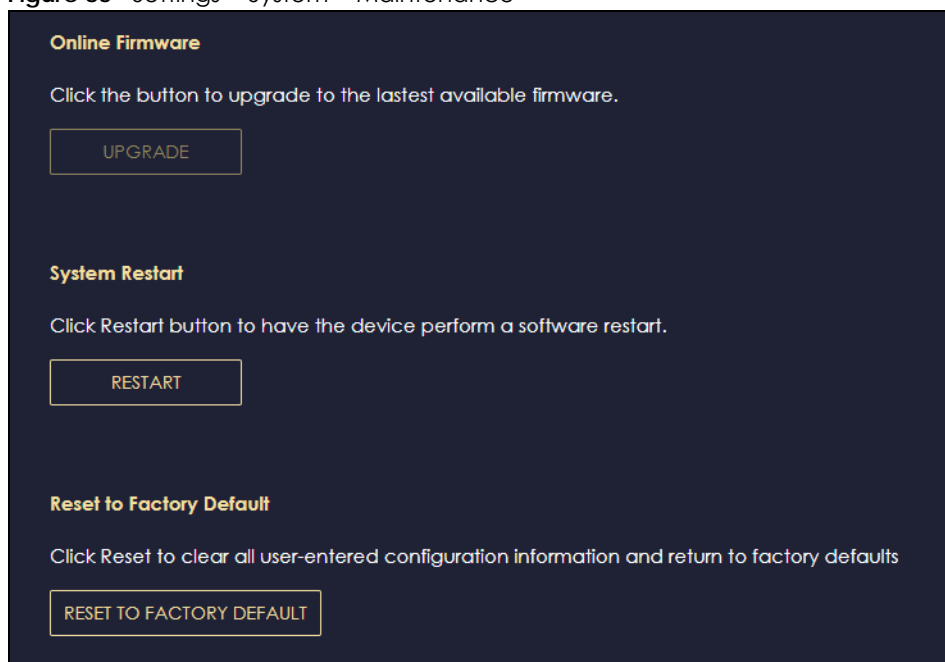

13.7 Operating Mode Screen

Use this screen to select how you want to use your NBG6818.

The **Operating Mode** function lets you configure your NBG6818 as a router or bridge. You can choose between **Standard Mode**, and **Bridge Mode** depending on your network topology and the features you require from your device.

The following describes the device modes available in your NBG6818.

Standard (Router)

A router connects your local network with another network, such as the Internet. The router has two IP addresses, the LAN IP address and the WAN IP address.

Figure 84 LAN and WAN IP Addresses in Standard Mode

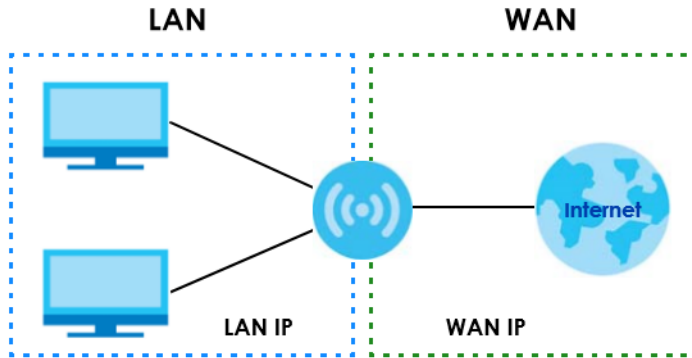

Bridge

A bridge enabled all Ethernet ports to be bridged together and be in the same subnet. To connect to the Internet, another device, such as a router, is required.

Figure 85 Bridge Mode

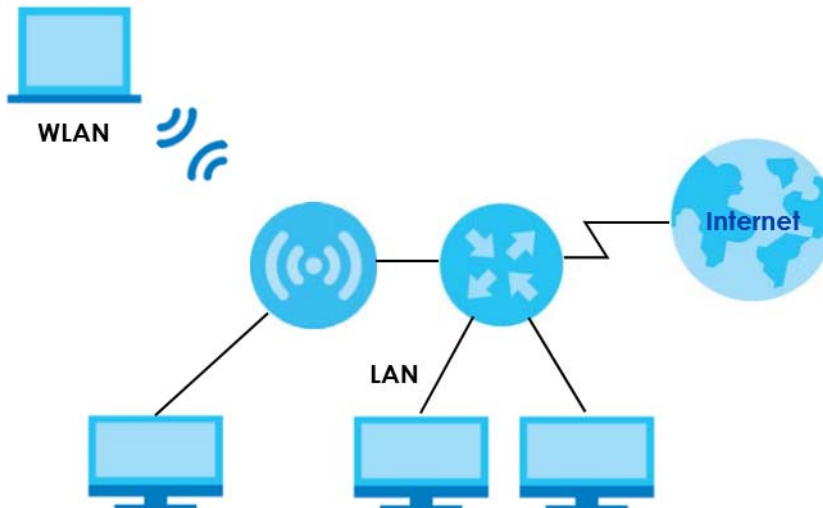

Click **Settings > System > Operating Mode** to show the following screen.

Figure 86 Settings > System > Operation Mode

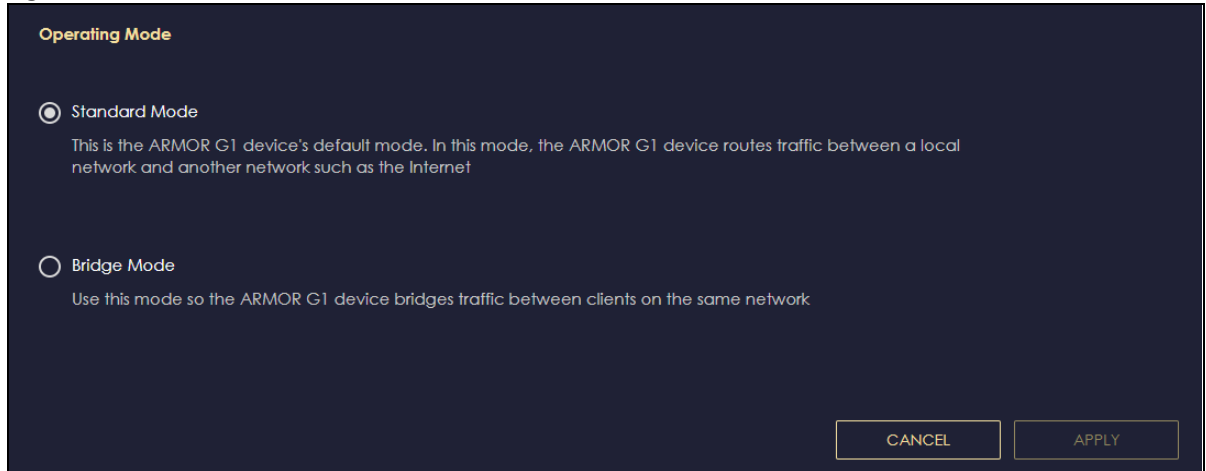

The following table describes the labels in this screen.

Table 49 Settings > System > Operation Mode

LABEL	DESCRIPTION
Standard Mode	Select Standard Mode if your device routes traffic between a local network and another network such as the Internet. This mode offers services such as a firewall or bandwidth management. You can configure the IP address settings on your WAN port. Contact your ISP or system administrator for more information on appropriate settings.
Bridge Mode	Select Bridge Mode if your device bridges traffic between clients on the same network. <ul style="list-style-type: none"> In Bridge Mode, all Ethernet ports have the same IP address. All ports on the rear panel of the device are LAN ports, including the port labeled WAN. There is no WAN port. The DHCP server on your device is disabled. Router functions (such as NAT, bandwidth management, remote management, firewall and so on) are not available when the NBG6818 is in Bridge Mode. The IP address of the device on the local network is set to 192.168.123.2.
Apply	Click Apply to save your settings.
Cancel	Click Cancel to return your settings to the default (Standard).

Note: If you select the incorrect system operation Mode you may not be able to connect to the Internet

13.8 Logs Screen

Use this screen to see the logged messages for the NBG6818.

You can configure which logs to display in the Log screen.

The newest log replaces the oldest log after it fills. Select what logs you want to see from the **Log Type** drop-down list box. The log choices depend on your other settings in the **System** screens. Click **Refresh** to renew the log screen. Click **Export** to save the current list of logs to your computer. Click **Clear** to delete all the logs.

Click **Apply** to save your settings. Click **Cancel** to discard all changes.

Click **Settings > System > Logs** to show the following screen.

Figure 87 Settings > System > Logs

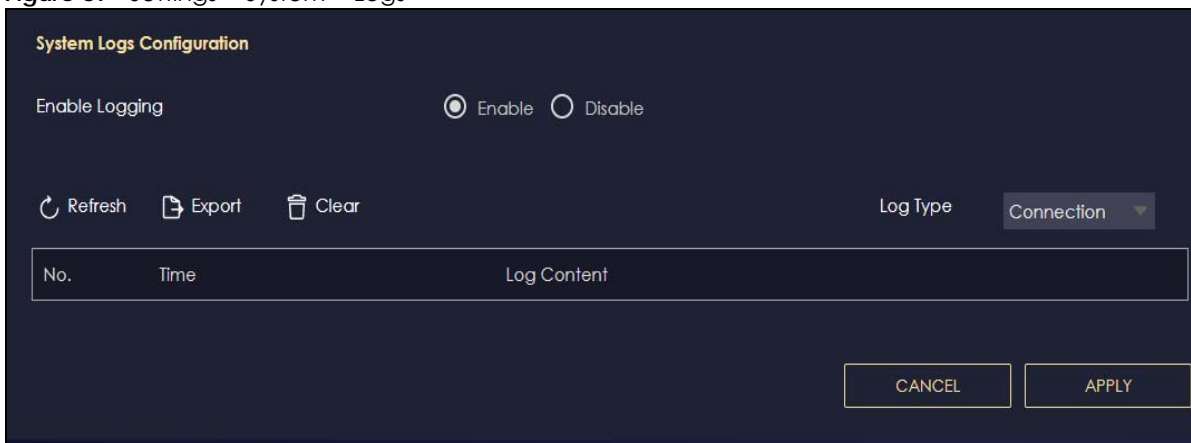

CHAPTER 14

Troubleshooting

14.1 Overview

This chapter offers some suggestions to solve problems you might encounter. The potential problems are divided into the following categories.

- [Power, Hardware Connections, and LEDs](#)
- [NBG6818 Access and Login](#)
- [Internet Access](#)
- [Resetting the NBG6818 to Its Factory Defaults](#)
- [Wireless Connections](#)
- [USB Device Problems](#)

14.2 Power, Hardware Connections, and LEDs

[The NBG6818 does not turn on. None of the LEDs turn on.](#)

- Make sure you are using the power adaptor or cord included with the NBG6818.
- Make sure the power adaptor or cord is connected to the NBG6818 and plugged in to an appropriate power source. Make sure the power source is turned on.
- Disconnect and re-connect the power adaptor or cord to the NBG6818.
- If the problem continues, contact the vendor.

[One of the LEDs does not behave as expected.](#)

- Make sure you understand the normal behavior of the LED. See [Section 1.7 on page 14](#).
- Check the hardware connections. See the Quick Start Guide.
- Inspect your cables for damage. Contact the vendor to replace any damaged cables.
- Disconnect and re-connect the power adaptor to the NBG6818.
- If the problem continues, contact the vendor.

14.3 NBG6818 Access and Login

I don't know the IP address of my NBG6818.

- The default IP address of the NBG6818 in **Standard Mode** is **192.168.123.1**. If the NBG6818 obtains a WAN IP address in the same subnet as the LAN IP address 192.168.123.1, the default LAN IP address will be changed to 10.0.0.1 automatically. See [Auto-IP Change on page 79](#) for more information. The default IP address of the NBG6818 in **Bridge Mode** is **192.168.123.2**.
- If you changed the IP address and have forgotten it, you might get the IP address of the NBG6818 in **Standard Mode** by looking up the IP address of the default gateway for your computer. To do this in most Windows computers, click **Start > Run**, enter **cmd**, and then enter **ipconfig**. The IP address of the **Default Gateway** might be the IP address of the NBG6818 (it depends on the network), so enter this IP address in your Internet browser.
- If your NBG6818 in **Bridge Mode** is a DHCP client, you can find your IP address from the DHCP server. This information is only available from the DHCP server which allocates IP addresses on your network. Find this information directly from the DHCP server or contact your system administrator for more information.
- Reset your NBG6818 to change all settings back to their default. This means your current settings are lost. See [Section 14.5 on page 144](#) in the **Troubleshooting** for information on resetting your NBG6818.

I cannot see or access the **Login** screen in the Web Configurator.

- Make sure you are using the correct IP address.
- The default IP address of the NBG6818 in **Standard Mode** is **192.168.123.1**. If the NBG6818 obtains a WAN IP address in the same subnet as the LAN IP address 192.168.123.1, the default LAN IP address will be changed to 10.0.0.1 automatically. See [Auto-IP Change on page 79](#) for more information. The default IP address of the NBG6818 in **Bridge Mode** is **192.168.123.2**.
- If you changed the IP address ([Section 11.4 on page 114](#)), use the new IP address.
- If you changed the IP address and have forgotten it, see the troubleshooting suggestions for [I don't know the IP address of my NBG6818](#).
- Check the hardware connections, and make sure the LEDs are behaving as expected. See the Quick Start Guide.
- Make sure your Internet browser does not block pop-up windows and has JavaScript and Java enabled. See [Appendix B on page 153](#) for more information.
- Make sure your computer is in the same subnet as the NBG6818. (If you know that there are routers between your computer and the NBG6818, skip this step.)
- If there is a DHCP server on your network, make sure your computer is using a dynamic IP address. See [Section 11.4 on page 114](#).
- If there is no DHCP server on your network, make sure your computer's IP address is in the same subnet as the NBG6818. See [Section 11.4 on page 114](#).
- Reset the device to its factory defaults, and try to access the NBG6818 with the default IP address. See [Section 1.5 on page 13](#).
- If the problem continues, contact the network administrator or vendor, or try one of the advanced suggestions.

Advanced Suggestions

- Try to access the NBG6818 using another service, such as Telnet. If you can access the NBG6818, check the remote management settings and firewall rules to find out why the NBG6818 does not respond to HTTP.
- If your computer is connected to the **WAN** port or is connected wirelessly, use a computer that is connected to a **LAN/ETHERNET** port.

I can see the **Login** screen, but I cannot log in to the NBG6818.

- This can happen when you fail to log out properly from your last session. Try logging in again after 5 minutes.
- Disconnect and re-connect the power adaptor or cord to the NBG6818.
- If this does not work, you have to reset the device to its factory defaults. See [Section 14.5 on page 144](#).

14.4 Internet Access

I cannot access the Internet.

- Check the hardware connections, and make sure the LEDs are behaving as expected. See the Quick Start Guide.
- Go to **Expert > Maintenance > Operation Mode**. Check your System Operation Mode setting.
If the NBG6818 is in **Standard Mode**, make sure the WAN port is connected to a broadband modem or router with Internet access. Your computer and the NBG6818 should be in the same subnet.
If the NBG6818 is in **Bridge Mode**, make sure the WAN port is connected to a broadband modem or router with Internet access and your computer is set to obtain a dynamic IP address.
- If the NBG6818 is in **Standard Mode**, make sure you entered your ISP account information correctly in the wizard or the WAN screen. These fields are case-sensitive, so make sure [Caps Lock] is not on.
- If you are trying to access the Internet wirelessly, make sure the wireless settings in the wireless client are the same as the settings in the AP.
- Disconnect all the cables from your device, and follow the directions in the Quick Start Guide again.
- If the problem continues, contact your ISP.

I cannot access the Internet anymore. I had access to the Internet (with the NBG6818), but my Internet connection is not available anymore.

- Check the hardware connections, and make sure the LEDs are behaving as expected. See the Quick Start Guide and [Section 1.7 on page 14](#).
- Reboot the NBG6818.

- If the problem continues, contact your ISP.

The Internet connection is slow or intermittent.

- There might be a lot of traffic on the network. Look at the LEDs, and check [Section 1.7 on page 14](#). If the NBG6818 is sending or receiving a lot of information, try closing some programs that use the Internet, especially peer-to-peer applications.
- Check the signal strength. If the signal strength is low, try moving the NBG6818 closer to the AP if possible, and look around to see if there are any devices that might be interfering with the wireless network (for example, microwaves, other wireless networks, and so on).
- Reboot the NBG6818.
- If the problem continues, contact the network administrator or vendor, or try one of the advanced suggestions.
- **Advanced Suggestion**
Check the settings for QoS. If it is disabled, you might consider activating it.

14.5 Resetting the NBG6818 to Its Factory Defaults

If you reset the NBG6818, you lose all of the changes you have made. The NBG6818 re-loads its default settings. You have to make all of your changes again.

You will lose all of your changes when you push the **RESET** button.

To reset the NBG6818:

- Make sure the power LED is on.
- Press the **RESET** button for one to four seconds to restart/reboot the NBG6818.
- Press the **RESET** button for longer than five seconds to set the NBG6818 back to its factory-default configurations.

If the NBG6818 restarts automatically, wait for the NBG6818 to finish restarting, and log in to the Web Configurator.

If the NBG6818 does not restart automatically, disconnect and reconnect the NBG6818's power. Then, follow the directions above again.

14.6 Wireless Connections

I cannot access the NBG6818 or ping any computer from the WLAN.

- Make sure the wireless LAN is enabled on the NBG6818.
- Make sure the wireless adapter on your computer is working properly.
- Make sure the wireless adapter installed on your computer is IEEE 802.11 compatible and supports the same wireless standard as the NBG6818.
- Make sure your computer (with a wireless adapter installed) is within the transmission range of the NBG6818.
- Check that both the NBG6818 and the wireless adapter on your computer are using the same wireless and wireless security settings.
- Make sure traffic between the WLAN and the LAN is not blocked by the firewall on the NBG6818.
- Make sure you allow the NBG6818 to be remotely accessed through the WLAN interface. Check your remote management settings.

See the chapter on [Wireless LAN](#) in the User's Guide for more information.

I cannot access the Web Configurator after I switched to Bridge Mode.

- When you change from **Standard Mode** to **Bridge Mode**, your computer must have an IP address in the range between "192.168.123.3" and "192.168.123.254".
- Refer to [Appendix B on page 153](#) for instructions on how to change your computer's IP address.

What factors may cause intermittent or unstabled wireless connection? How can I solve this problem?

The following factors may cause interference:

- Obstacles: walls, ceilings, furniture, and so on.
- Building Materials: metal doors, aluminum studs.
- Electrical devices: microwaves, monitors, electric motors, cordless phones, and other wireless devices.

To optimize the speed and quality of your wireless connection, you can:

- Move your wireless device closer to the AP if the signal strength is low.
- Reduce wireless interference that may be caused by other wireless networks or surrounding wireless electronics such as cordless phones.
- Place the AP where there are minimum obstacles (such as walls and ceilings) between the AP and the wireless client.
- Reduce the number of wireless clients connecting to the same AP simultaneously, or add additional APs if necessary.
- Try closing some programs that use the Internet, especially peer-to-peer applications. If the wireless client is sending or receiving a lot of information, it may have too many programs open that use the Internet.
- Position the antennas for best reception. If the AP is placed on a table or floor, point the antennas upwards. If the AP is placed at a high position, point the antennas downwards. Try pointing the antennas in different directions and check which provides the strongest signal to the wireless clients.

14.7 USB Device Problems

I cannot access or see a USB device that is connected to the NBG6818.

- Disconnect the problematic USB device, then reconnect it to the NBG6818.
 - Ensure that the USB device has power.
 - Check your cable connections.
 - Restart the NBG6818 by disconnecting the power and then reconnecting it.
 - If the USB device requires a special driver, install the driver from the installation disc that came with the device. After driver installation, reconnect the USB device to the NBG6818 and try to connect to it again with your computer.
 - If the problem persists, contact your vendor.
-

What kind of USB devices do the NBG6818 support?

- It is strongly recommended to use version 2.0 or higher USB storage devices (such as NTFS or FAT32 file system, USB hard drives) and/or USB devices. Other USB products are not guaranteed to function properly with the NBG6818.
- The NBG6818 do not support 3G/4G USB dongles.

APPENDIX A

Customer Support

In the event of problems that cannot be solved by using this manual, you should contact your vendor. If you cannot contact your vendor, then contact a Zyxel office for the region in which you bought the device.

See <https://www.zyxel.com/homepage.shtml> and also https://www.zyxel.com/about_zyxel/zyxel_worldwide.shtml for the latest information.

Please have the following information ready when you contact an office.

Required Information

- Product model and serial number.
- Warranty Information.
- Date that you received your device.
- Brief description of the problem and the steps you took to solve it.

Corporate Headquarters (Worldwide)

Taiwan

- Zyxel Communications Corporation
- <http://www.zyxel.com>

Asia

China

- Zyxel Communications (Shanghai) Corp.
- Zyxel Communications (Beijing) Corp.
- Zyxel Communications (Tianjin) Corp.
- <https://www.zyxel.com/cn/zh/>

India

- Zyxel Technology India Pvt Ltd
- <https://www.zyxel.com/in/en/>

Kazakhstan

- Zyxel Kazakhstan
- <https://www.zyxel.kz>

Korea

- Zyxel Korea Corp.
- <http://www.zyxel.kr>

Malaysia

- Zyxel Malaysia Sdn Bhd.
- <http://www.zyxel.com.my>

Pakistan

- Zyxel Pakistan (Pvt.) Ltd.
- <http://www.zyxel.com.pk>

Philippines

- Zyxel Philippines
- <http://www.zyxel.com.ph>

Singapore

- Zyxel Singapore Pte Ltd.
- <http://www.zyxel.com.sg>

Taiwan

- Zyxel Communications Corporation
- <https://www.zyxel.com/tw/zh/>

Thailand

- Zyxel Thailand Co., Ltd.
- <https://www.zyxel.com/th/th/>

Vietnam

- Zyxel Communications Corporation-Vietnam Office
- <https://www.zyxel.com/vn/vi>

Europe

Belarus

- Zyxel BY
- <https://www.zyxel.by>

Belgium

- Zyxel Communications B.V.
- <https://www.zyxel.com/be/nl/>

- <https://www.zyxel.com/be/fr/>

Bulgaria

- Zyxel България
- <https://www.zyxel.com/bg/bg/>

Czech Republic

- Zyxel Communications Czech s.r.o
- <https://www.zyxel.com/cz/cs/>

Denmark

- Zyxel Communications A/S
- <https://www.zyxel.com/dk/da/>

Estonia

- Zyxel Estonia
- <https://www.zyxel.com/ee/et/>

Finland

- Zyxel Communications
- <https://www.zyxel.com/fi/fi/>

France

- Zyxel France
- <https://www.zyxel.fr>

Germany

- Zyxel Deutschland GmbH
- <https://www.zyxel.com/de/de/>

Hungary

- Zyxel Hungary & SEE
- <https://www.zyxel.com/hu/hu/>

Italy

- Zyxel Communications Italy
- <https://www.zyxel.com/it/it/>

Latvia

- Zyxel Latvia
- <https://www.zyxel.com/lv/lv/>

Lithuania

- Zyxel Lithuania
- <https://www.zyxel.com/lt/lt/>

Netherlands

- Zyxel Benelux
- <https://www.zyxel.com/nl/nl/>

Norway

- Zyxel Communications
- <https://www.zyxel.com/no/no/>

Poland

- Zyxel Communications Poland
- <https://www.zyxel.com/pl/pl/>

Romania

- Zyxel Romania
- <https://www.zyxel.com/ro/ro>

Russia

- Zyxel Russia
- <https://www.zyxel.com/ru/ru/>

Slovakia

- Zyxel Communications Czech s.r.o. organizacna zlozka
- <https://www.zyxel.com/sk/sk/>

Spain

- Zyxel Communications ES Ltd.
- <https://www.zyxel.com/es/es/>

Sweden

- Zyxel Communications
- <https://www.zyxel.com/se/sv/>

Switzerland

- Studerus AG
- <https://www.zyxel.ch/de>
- <https://www.zyxel.ch/fr>

Turkey

- Zyxel Turkey A.S.
- <https://www.zyxel.com/tr/tr/>

UK

- Zyxel Communications UK Ltd.
- <https://www.zyxel.com/uk/en/>

Ukraine

- Zyxel Ukraine
- <http://www.ua.zyxel.com>

South America

Argentina

- Zyxel Communications Corporation
- <https://www.zyxel.com/co/es/>

Brazil

- Zyxel Communications Brasil Ltda.
- <https://www.zyxel.com/br/pt/>

Colombia

- Zyxel Communications Corporation
- <https://www.zyxel.com/co/es/>

Ecuador

- Zyxel Communications Corporation
- <https://www.zyxel.com/co/es/>

South America

- Zyxel Communications Corporation
- <https://www.zyxel.com/co/es/>

Middle East

Israel

- Zyxel Communications Corporation
- <http://il.zyxel.com/>

Middle East

- Zyxel Communications Corporation
- <https://www.zyxel.com/me/en/>

North America

USA

- Zyxel Communications, Inc. - North America Headquarters
- <https://www.zyxel.com/us/en/>

Oceania

Australia

- Zyxel Communications Corporation
- <https://www.zyxel.com/au/en/>

Africa

South Africa

- Nology (Pty) Ltd.
- <https://www.zyxel.com/za/en/>

APPENDIX B

Setting Up Your Computer's IP Address

Note: Your specific NBG6818 may not support all of the operating systems described in this appendix. See the product specifications for more information about which operating systems are supported.

This appendix shows you how to configure the IP settings on your computer in order for it to be able to communicate with the other devices on your network. Windows Vista/XP/2000, Mac OS 9/OS X, and all versions of UNIX/LINUX include the software components you need to use TCP/IP on your computer.

If you manually assign IP information instead of using a dynamic IP, make sure that your network's computers have IP addresses that place them in the same subnet.

In this appendix, you can set up an IP address for:

- [Windows 7 on page 153](#)
- [Mac OS X: 10.3 and 10.4 on page 157](#)
- [Mac OS X: 10.5 and 10.6 on page 159](#)
- [Linux: Ubuntu 8 \(GNOME\) on page 163](#)
- [Linux: openSUSE 10.3 \(KDE\) on page 166](#)

Windows 7

This section shows screens from Windows 7 Enterprise.

- 1 Click **Start > Control Panel**.

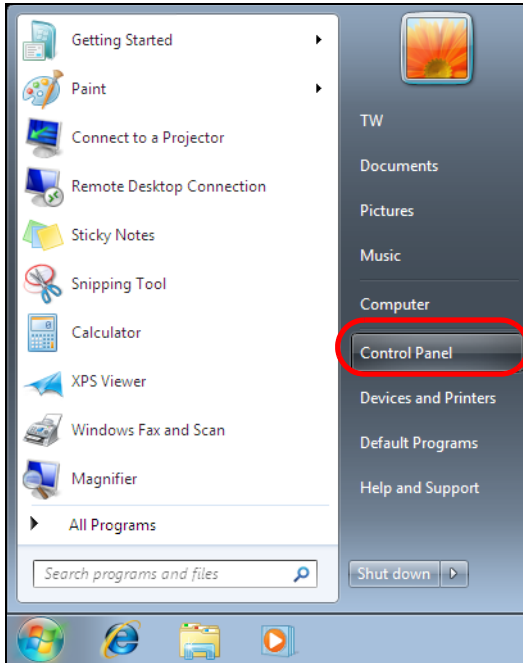

- 2 In the **Control Panel**, click **View network status and tasks** under the **Network and Internet** category.

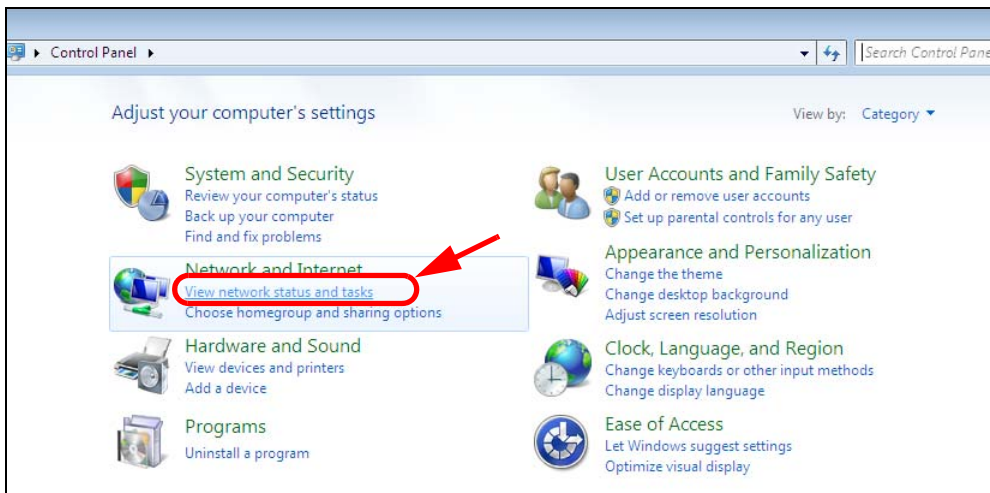

- 3 Click **Change adapter settings**.

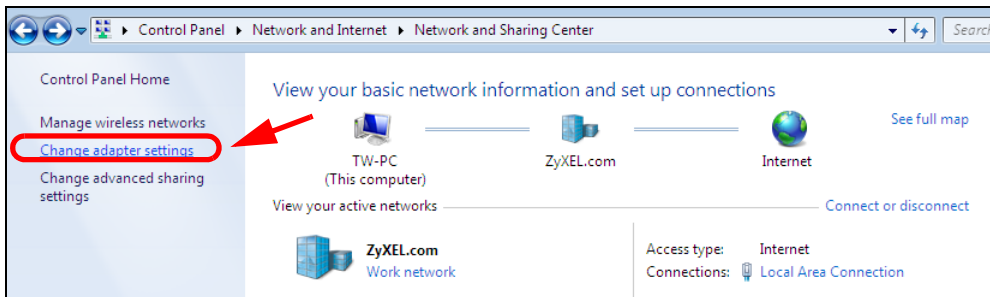

- 4 Double click **Local Area Connection** and then select **Properties**.

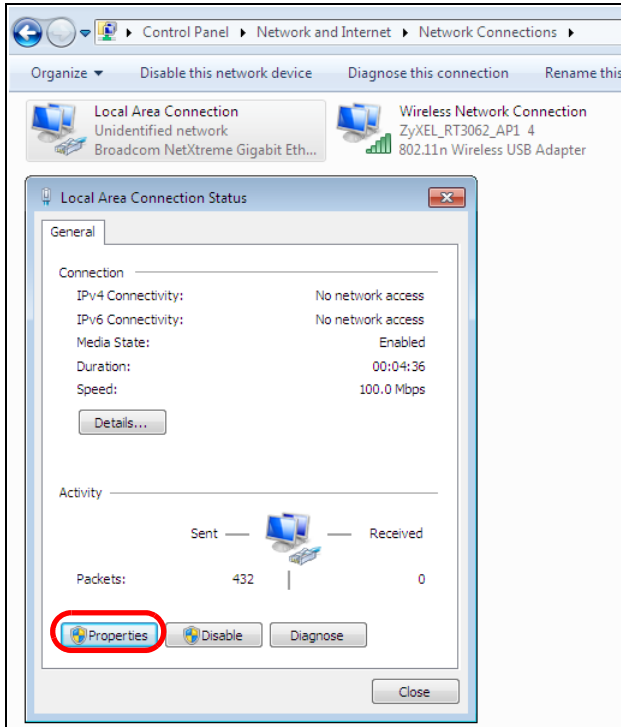

Note: During this procedure, click **Continue** whenever Windows displays a screen saying that it needs your permission to continue.

- 5 Select **Internet Protocol Version 4 (TCP/IPv4)** and then select **Properties**.

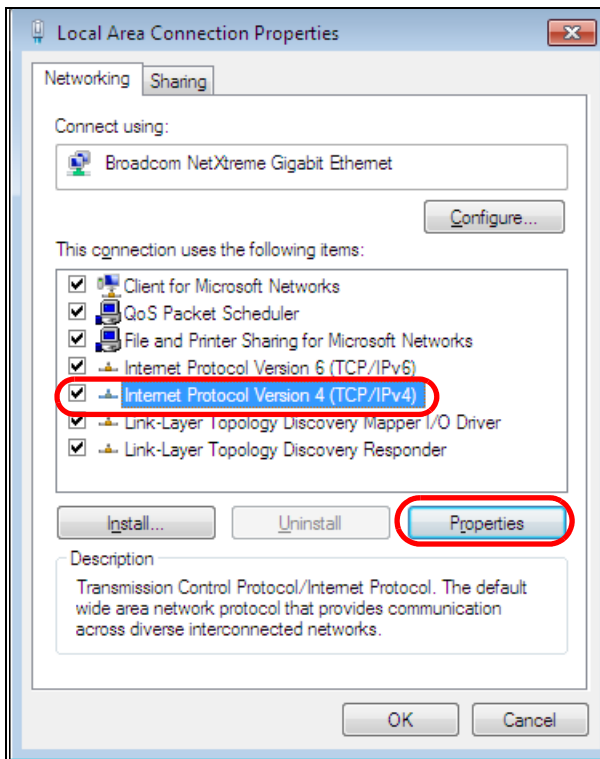

- 6 The **Internet Protocol Version 4 (TCP/IPv4) Properties** window opens.

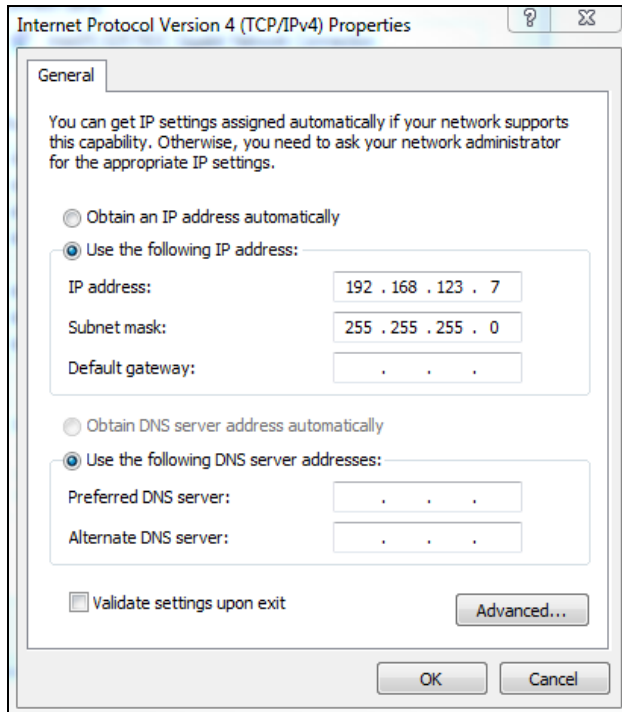

- 7 Select **Obtain an IP address automatically** if your network administrator or ISP assigns your IP address dynamically.

Select **Use the following IP Address** and fill in the **IP address**, **Subnet mask**, and **Default gateway** fields if you have a static IP address that was assigned to you by your network administrator or ISP. You may also have to enter a **Preferred DNS server** and an **Alternate DNS server**, if that information was provided. Click **Advanced** if you want to configure advanced settings for IP, DNS and WINS.

- 8 Click **OK** to close the **Internet Protocol (TCP/IP) Properties** window.
- 9 Click **OK** to close the **Local Area Connection Properties** window.

Verifying Settings

- 1 Click **Start > All Programs > Accessories > Command Prompt**.
- 2 In the **Command Prompt** window, type "ipconfig" and then press [ENTER].
- 3 The IP settings are displayed as follows.

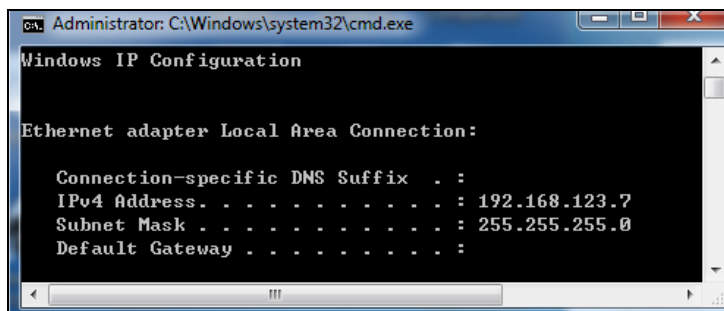

Mac OS X: 10.3 and 10.4

The screens in this section are from Mac OS X 10.4 but can also apply to 10.3.

- 1 Click **Apple > System Preferences**.

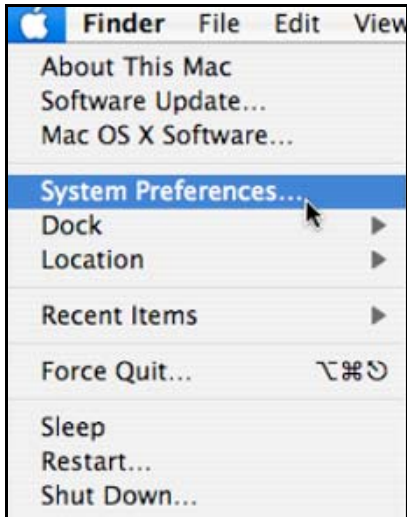

- 2 In the **System Preferences** window, click the **Network** icon.

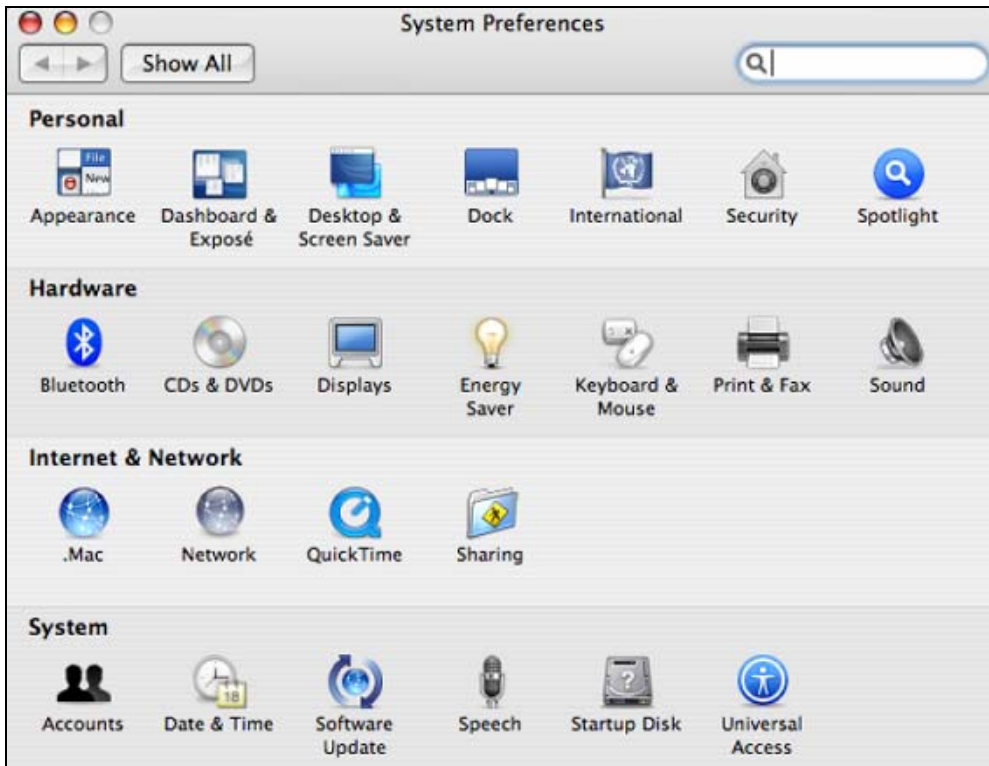

- 3 When the **Network** preferences pane opens, select **Built-in Ethernet** from the network connection type list, and then click **Configure**.

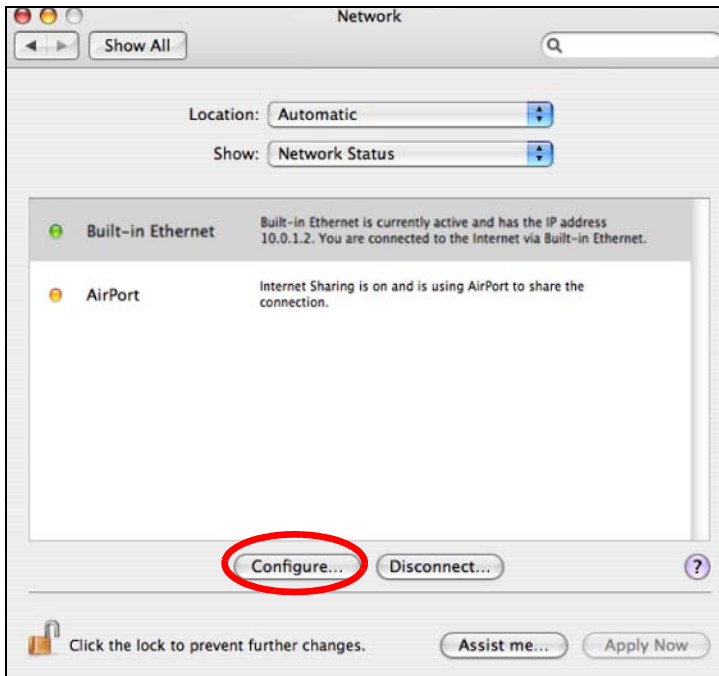

- 4 For dynamically assigned settings, select **Using DHCP** from the **Configure IPv4** list in the **TCP/IP** tab.

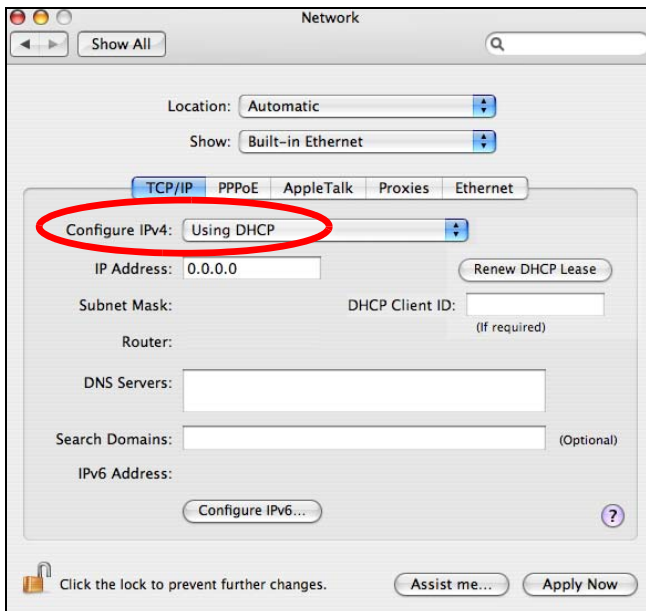

- 5 For statically assigned settings, do the following:
- From the **Configure IPv4** list, select **Manually**.
 - In the **IP Address** field, type your IP address.
 - In the **Subnet Mask** field, type your subnet mask.
 - In the **Router** field, type the IP address of your device.

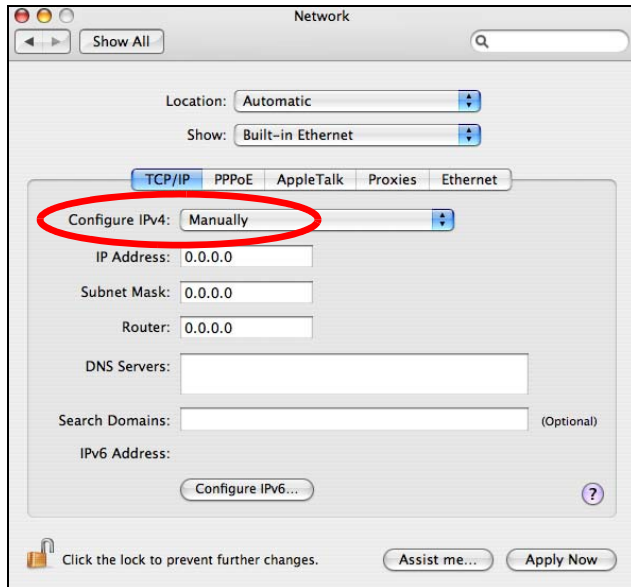

- 6 Click **Apply Now** and close the window.

Verifying Settings

Check your TCP/IP properties by clicking **Applications > Utilities > Network Utilities**, and then selecting the appropriate **Network Interface** from the **Info** tab.

Figure 88 Mac OS X 10.4: Network Utility

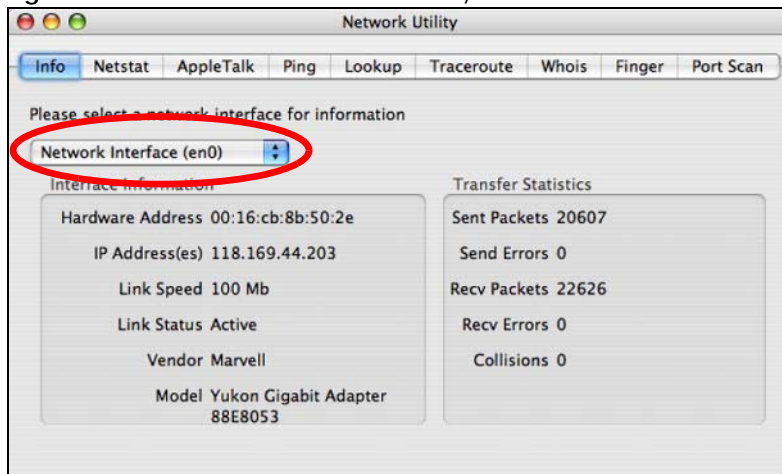

Mac OS X: 10.5 and 10.6

The screens in this section are from Mac OS X 10.5 but can also apply to 10.6.

- 1 Click **Apple > System Preferences**.

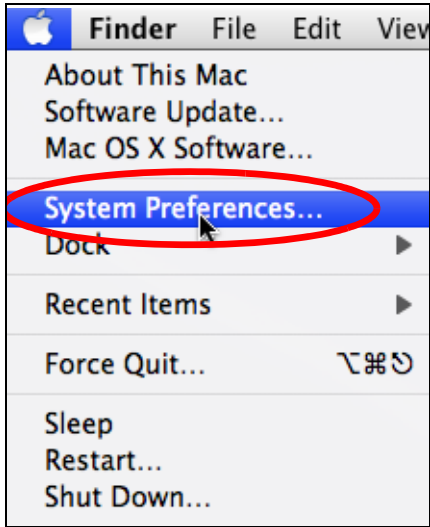

- 2 In System Preferences, click the **Network** icon.



- 3 When the **Network** preferences pane opens, select **Ethernet** from the list of available connection types.

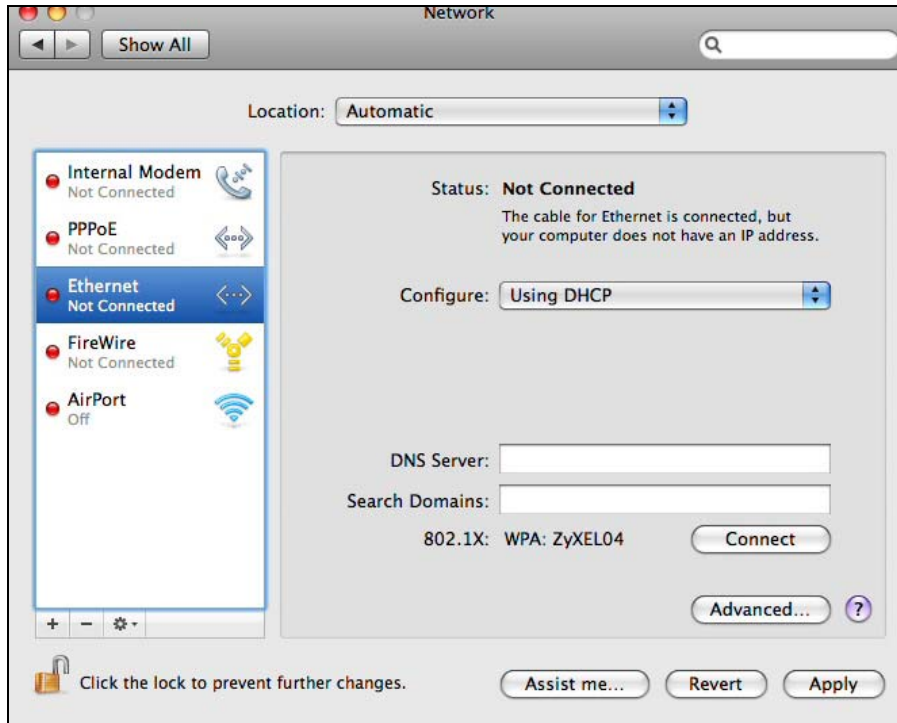

- 4 From the **Configure** list, select **Using DHCP** for dynamically assigned settings.
- 5 For statically assigned settings, do the following:
 - From the **Configure** list, select **Manually**.
 - In the **IP Address** field, enter your IP address.
 - In the **Subnet Mask** field, enter your subnet mask.
 - In the **Router** field, enter the IP address of your NBG6818.

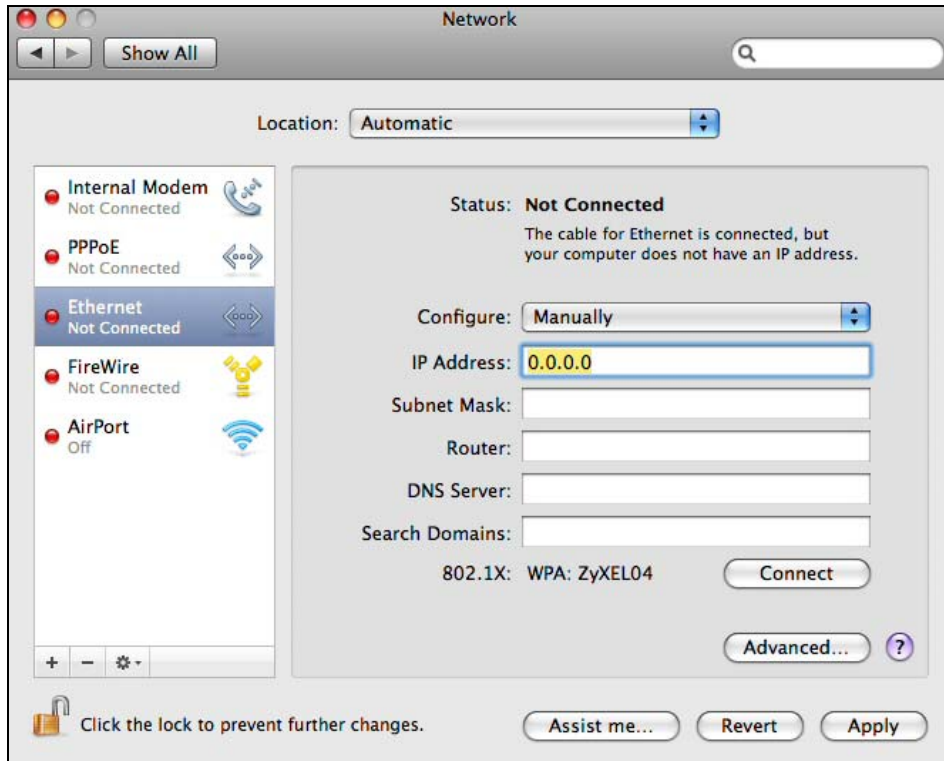

- 6 Click **Apply** and close the window.

Verifying Settings

Check your TCP/IP properties by clicking **Applications > Utilities > Network Utilities**, and then selecting the appropriate **Network interface** from the **Info** tab.

Figure 89 Mac OS X 10.5: Network Utility

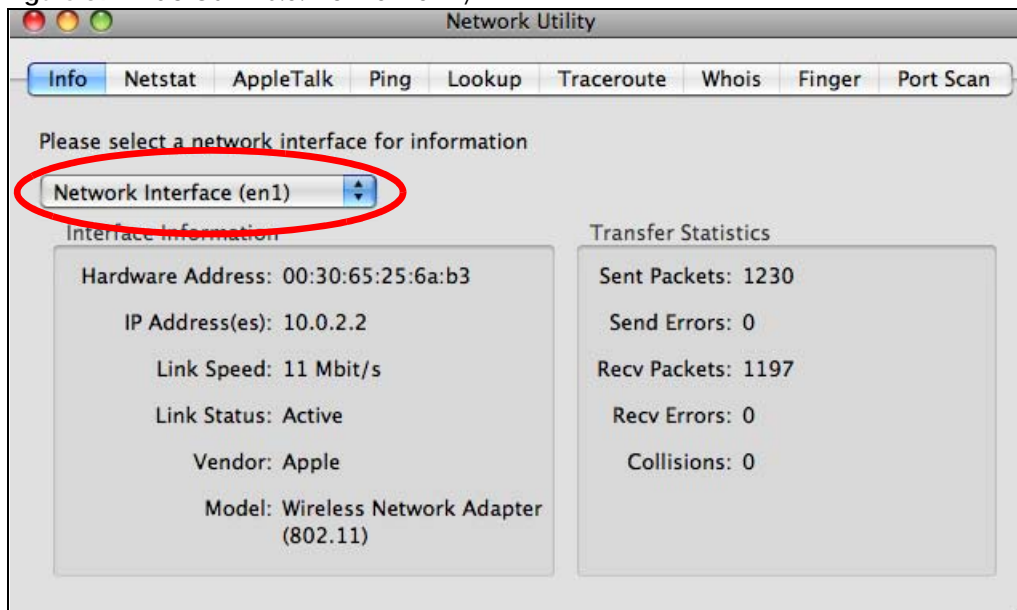

Linux: Ubuntu 8 (GNOME)

This section shows you how to configure your computer's TCP/IP settings in the GNU Object Model Environment (GNOME) using the Ubuntu 8 Linux distribution. The procedure, screens and file locations may vary depending on your specific distribution, release version, and individual configuration. The following screens use the default Ubuntu 8 installation.

Note: Make sure you are logged in as the root administrator.

Follow the steps below to configure your computer IP address in GNOME:

- 1 Click **System > Administration > Network**.

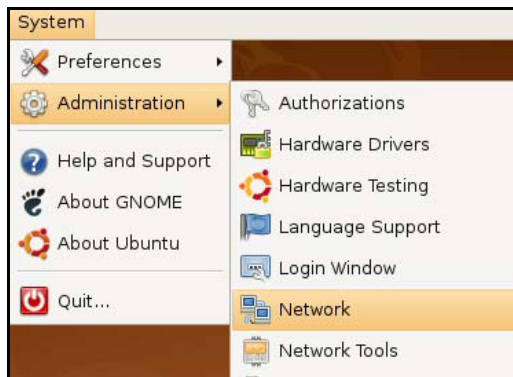

- 2 When the **Network Settings** window opens, click **Unlock** to open the **Authenticate** window. (By default, the **Unlock** button is greyed out until clicked.) You cannot make changes to your configuration unless you first enter your admin password.

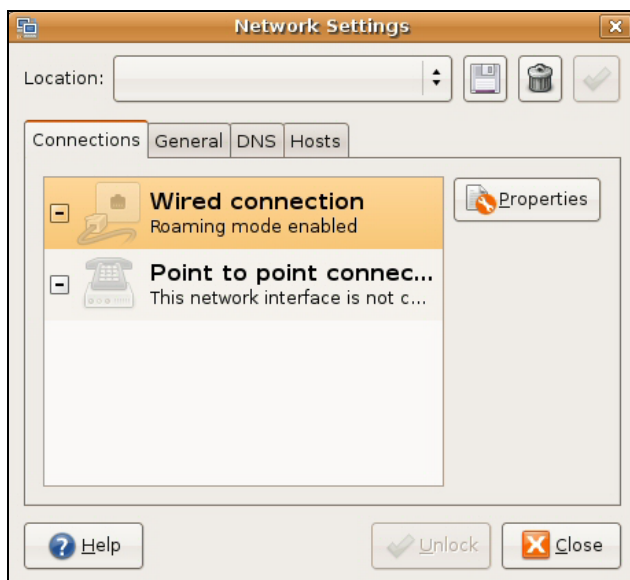

- 3 In the **Authenticate** window, enter your admin account name and password then click the **Authenticate** button.

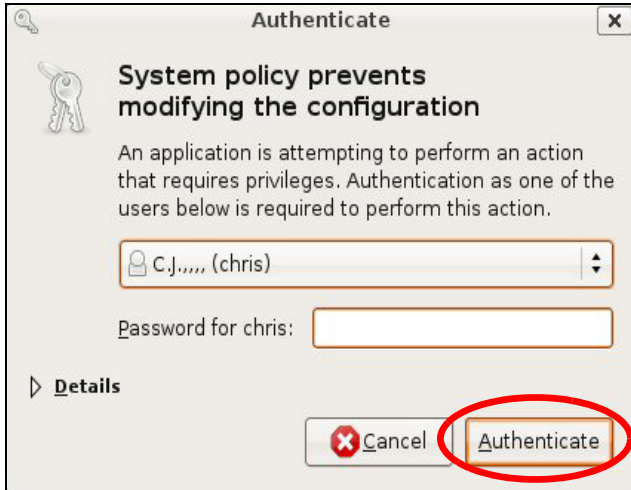

- 4 In the **Network Settings** window, select the connection that you want to configure, then click **Properties**.

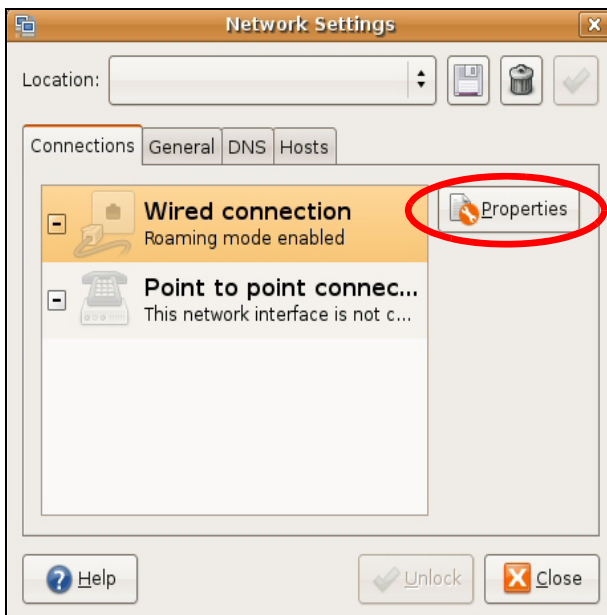

- 5 The **Properties** dialog box opens.

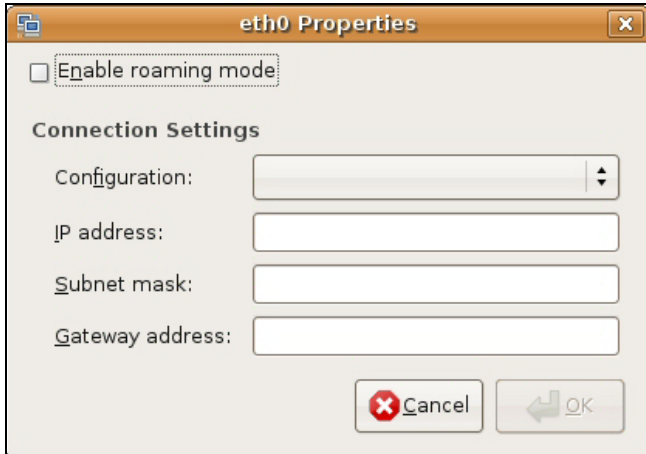

- In the **Configuration** list, select **Automatic Configuration (DHCP)** if you have a dynamic IP address.
 - In the **Configuration** list, select **Static IP address** if you have a static IP address. Fill in the **IP address**, **Subnet mask**, and **Gateway address** fields.
- 6 Click **OK** to save the changes and close the **Properties** dialog box and return to the **Network Settings** screen.
 - 7 If you know your DNS server IP address(es), click the **DNS** tab in the **Network Settings** window and then enter the DNS server information in the fields provided.

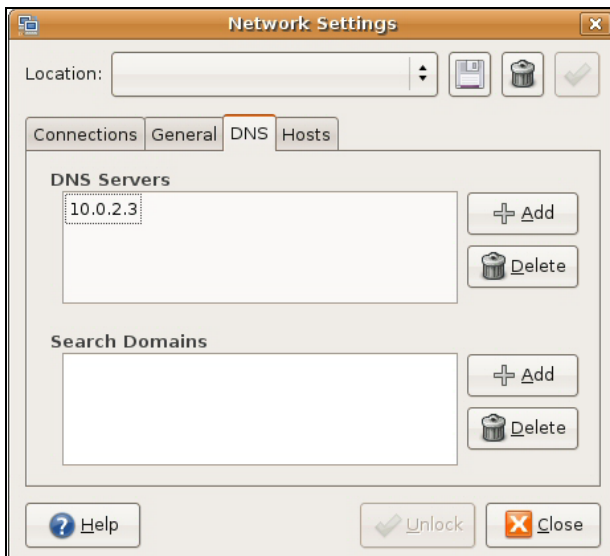

- 8 Click the **Close** button to apply the changes.

Verifying Settings

Check your TCP/IP properties by clicking **System > Administration > Network Tools**, and then selecting the appropriate **Network device** from the **Devices** tab. The **Interface Statistics** column shows data if your connection is working properly.

Figure 90 Ubuntu 8: Network Tools

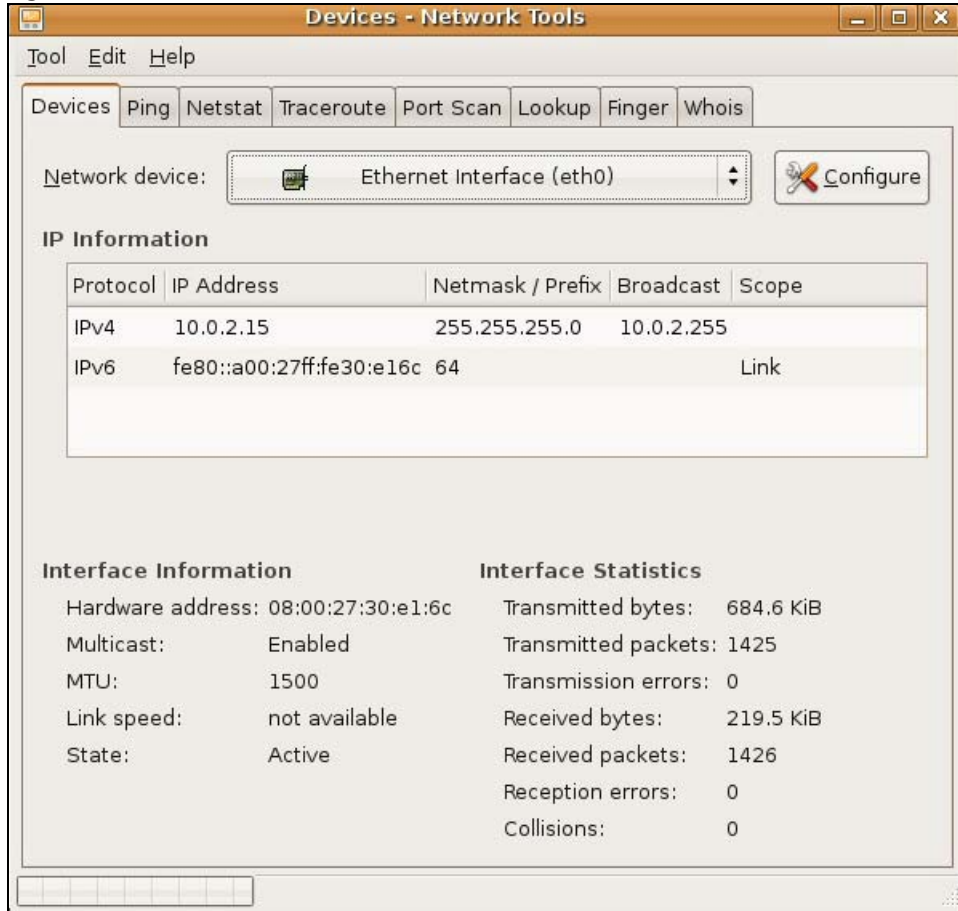

Linux: openSUSE 10.3 (KDE)

This section shows you how to configure your computer's TCP/IP settings in the K Desktop Environment (KDE) using the openSUSE 10.3 Linux distribution. The procedure, screens and file locations may vary depending on your specific distribution, release version, and individual configuration. The following screens use the default openSUSE 10.3 installation.

Note: Make sure you are logged in as the root administrator.

Follow the steps below to configure your computer IP address in the KDE:

- 1 Click **K Menu > Computer > Administrator Settings (YaST)**.

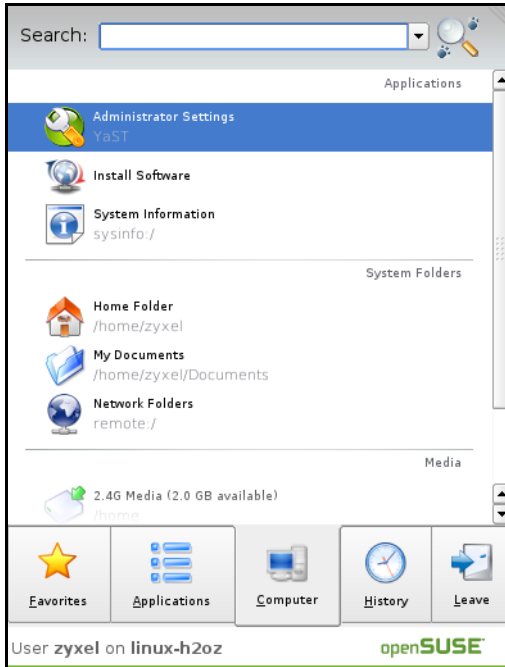

- 2 When the **Run as Root - KDE su** dialog opens, enter the admin password and click **OK**.

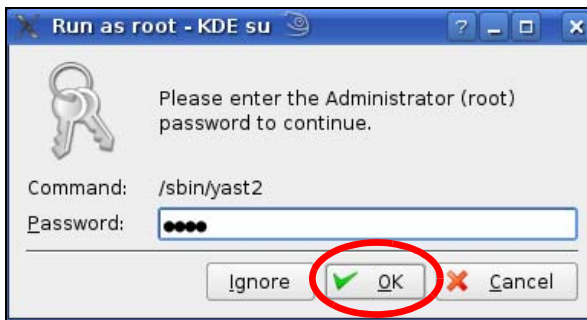

- 3 When the **YaST Control Center** window opens, select **Network Devices** and then click the **Network Card** icon.

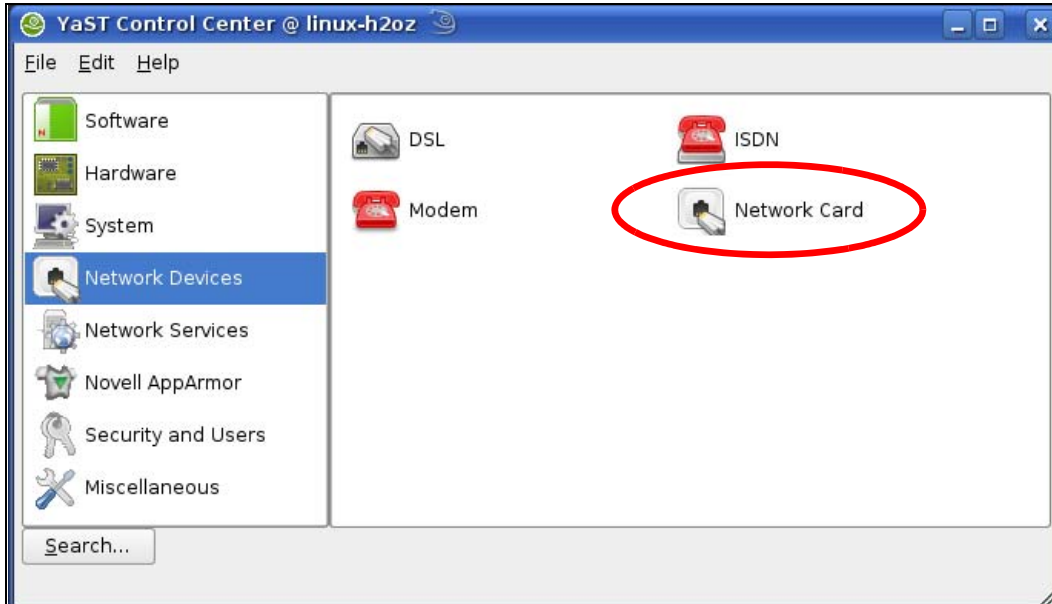

- 4 When the **Network Settings** window opens, click the **Overview** tab, select the appropriate connection **Name** from the list, and then click the **Configure** button.

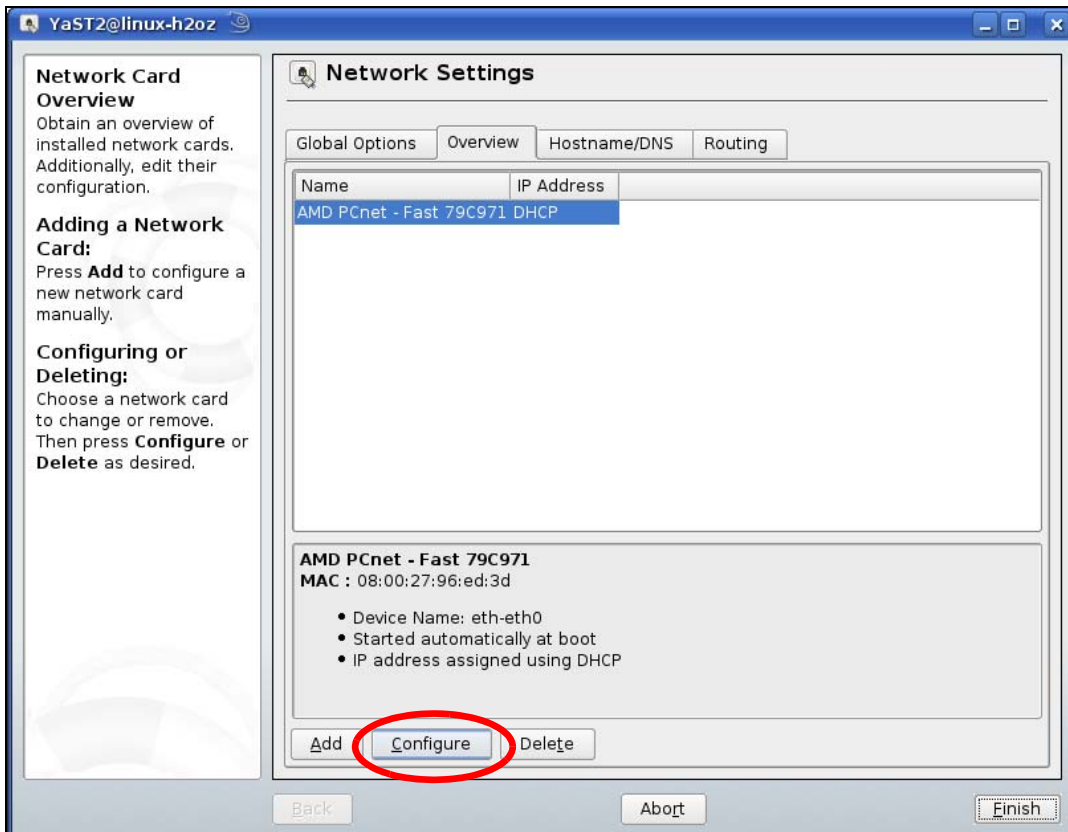

- 5 When the **Network Card Setup** window opens, click the **Address** tab

Figure 91 openSUSE 10.3: Network Card Setup

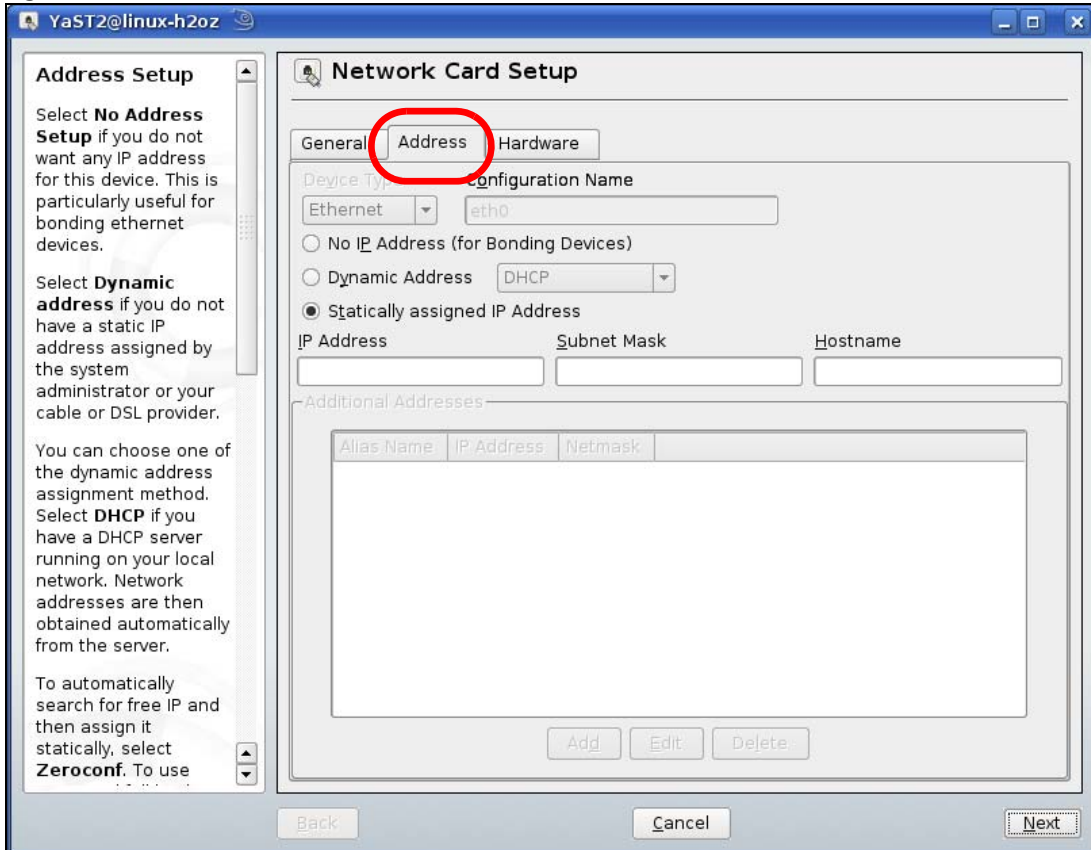

- 6 Select **Dynamic Address (DHCP)** if you have a dynamic IP address.
Select **Statically assigned IP Address** if you have a static IP address. Fill in the **IP address**, **Subnet mask**, and **Hostname** fields.
- 7 Click **Next** to save the changes and close the **Network Card Setup** window.
- 8 If you know your DNS server IP address(es), click the **Hostname/DNS** tab in **Network Settings** and then enter the DNS server information in the fields provided.

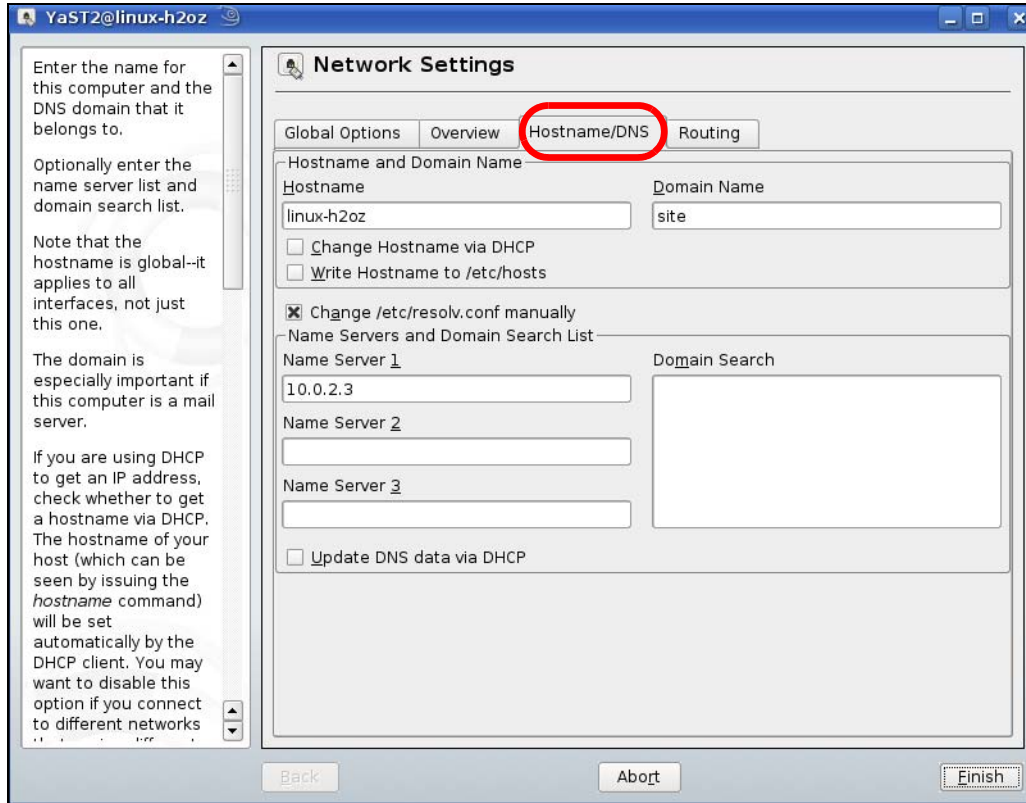

- 9 Click **Finish** to save your settings and close the window.

Verifying Settings

Click the **KNetwork Manager** icon on the **Task bar** to check your TCP/IP properties. From the **Options** sub-menu, select **Show Connection Information**.

Figure 92 openSUSE 10.3: KNetwork Manager

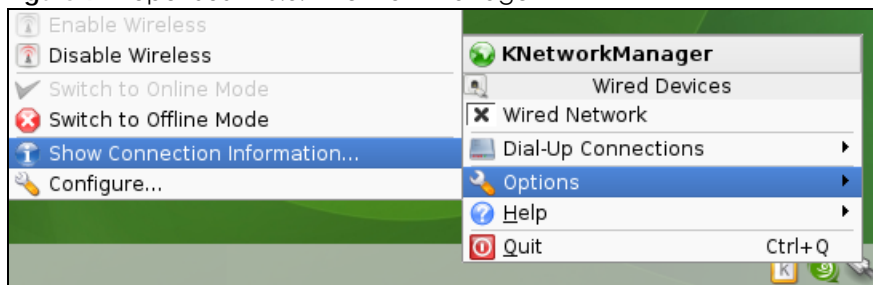

When the **Connection Status - KNetwork Manager** window opens, click the **Statistics** tab to see if your connection is working properly.

Figure 93 openSUSE: Connection Status - KNetwork Manager

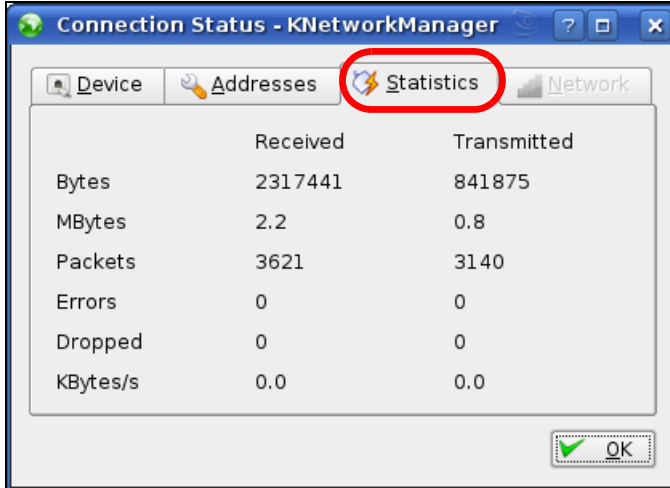

APPENDIX C

Common Services

The following table lists some commonly-used services and their associated protocols and port numbers. For a comprehensive list of port numbers, ICMP type/code numbers and services, visit the IANA (Internet Assigned Number Authority) web site.

- **Name:** This is a short, descriptive name for the service. You can use this one or create a different one, if you like.
- **Protocol:** This is the type of IP protocol used by the service. If this is **TCP/UDP**, then the service uses the same port number with TCP and UDP. If this is **USER-DEFINED**, the **Port(s)** is the IP protocol number, not the port number.
- **Port(s):** This value depends on the **Protocol**. Please refer to RFC 1700 for further information about port numbers.
 - If the **Protocol** is **TCP, UDP, or TCP/UDP**, this is the IP port number.
 - If the **Protocol** is **USER**, this is the IP protocol number.
- **Description:** This is a brief explanation of the applications that use this service or the situations in which this service is used.

Table 50 Commonly Used Services

NAME	PROTOCOL	PORT(S)	DESCRIPTION
AH (IPSEC_TUNNEL)	User-Defined	51	The IPSEC AH (Authentication Header) tunneling protocol uses this service.
AIM/New-ICQ	TCP	5190	AOL's Internet Messenger service. It is also used as a listening port by ICQ.
AUTH	TCP	113	Authentication protocol used by some servers.
BGP	TCP	179	Border Gateway Protocol.
BOOTP_CLIENT	UDP	68	DHCP Client.
BOOTP_SERVER	UDP	67	DHCP Server.
CU-SEEME	TCP UDP	7648 24032	A popular videoconferencing solution from White Pines Software.
DNS	TCP/UDP	53	Domain Name Server, a service that matches web names (for example www.zyxel.com) to IP numbers.
ESP (IPSEC_TUNNEL)	User-Defined	50	The IPSEC ESP (Encapsulation Security Protocol) tunneling protocol uses this service.
FINGER	TCP	79	Finger is a UNIX or Internet related command that can be used to find out if a user is logged on.
FTP	TCP TCP	20 21	File Transfer Program, a program to enable fast transfer of files, including large files that may not be possible by e-mail.
H.323	TCP	1720	NetMeeting uses this protocol.
HTTP	TCP	80	Hyper Text Transfer Protocol - a client/server protocol for the world wide web.
HTTPS	TCP	443	HTTPS is a secured http session often used in e-commerce.

Table 50 Commonly Used Services (continued)

NAME	PROTOCOL	PORT(S)	DESCRIPTION
ICMP	User-Defined	1	Internet Control Message Protocol is often used for diagnostic or routing purposes.
ICQ	UDP	4000	This is a popular Internet chat program.
IGMP (MULTICAST)	User-Defined	2	Internet Group Management Protocol is used when sending packets to a specific group of hosts.
IKE	UDP	500	The Internet Key Exchange algorithm is used for key distribution and management.
IRC	TCP/UDP	6667	This is another popular Internet chat program.
MSN Messenger	TCP	1863	Microsoft Networks' messenger service uses this protocol.
NEW-ICQ	TCP	5190	An Internet chat program.
NEWS	TCP	144	A protocol for news groups.
NFS	UDP	2049	Network File System - NFS is a client/server distributed file service that provides transparent file sharing for network environments.
NNTP	TCP	119	Network News Transport Protocol is the delivery mechanism for the USENET newsgroup service.
PING	User-Defined	1	Packet INternet Groper is a protocol that sends out ICMP echo requests to test whether or not a remote host is reachable.
POP3	TCP	110	Post Office Protocol version 3 lets a client computer get e-mail from a POP3 server through a temporary connection (TCP/IP or other).
PPTP	TCP	1723	Point-to-Point Tunneling Protocol enables secure transfer of data over public networks. This is the control channel.
PPTP_TUNNEL (GRE)	User-Defined	47	PPTP (Point-to-Point Tunneling Protocol) enables secure transfer of data over public networks. This is the data channel.
RCMD	TCP	512	Remote Command Service.
REAL_AUDIO	TCP	7070	A streaming audio service that enables real time sound over the web.
REXEC	TCP	514	Remote Execution Daemon.
RLOGIN	TCP	513	Remote Login.
RTELNET	TCP	107	Remote Telnet.
RTSP	TCP/UDP	554	The Real Time Streaming (media control) Protocol (RTSP) is a remote control for multimedia on the Internet.
SFTP	TCP	115	Simple File Transfer Protocol.
SMTP	TCP	25	Simple Mail Transfer Protocol is the message-exchange standard for the Internet. SMTP enables you to move messages from one e-mail server to another.
SNMP	TCP/UDP	161	Simple Network Management Program.
SNMP-TRAPS	TCP/UDP	162	Traps for use with the SNMP (RFC:1215).
SQL-NET	TCP	1521	Structured Query Language is an interface to access data on many different types of database systems, including mainframes, midrange systems, UNIX systems and network servers.
SSH	TCP/UDP	22	Secure Shell Remote Login Program.

Table 50 Commonly Used Services (continued)

NAME	PROTOCOL	PORT(S)	DESCRIPTION
STRM WORKS	UDP	1558	Stream Works Protocol.
SYSLOG	UDP	514	Syslog allows you to send system logs to a UNIX server.
TACACS	UDP	49	Login Host Protocol used for (Terminal Access Controller Access Control System).
TELNET	TCP	23	Telnet is the login and terminal emulation protocol common on the Internet and in UNIX environments. It operates over TCP/IP networks. Its primary function is to allow users to log into remote host systems.
TFTP	UDP	69	Trivial File Transfer Protocol is an Internet file transfer protocol similar to FTP, but uses the UDP (User Datagram Protocol) rather than TCP (Transmission Control Protocol).
VDOLIVE	TCP	7000	Another videoconferencing solution.

APPENDIX D

Legal Information

Copyright

Copyright © 2020 by Zyxel Communications Corporation.

The contents of this publication may not be reproduced in any part or as a whole, transcribed, stored in a retrieval system, translated into any language, or transmitted in any form or by any means, electronic, mechanical, magnetic, optical, chemical, photocopying, manual, or otherwise, without the prior written permission of Zyxel Communications Corporation.

Published by Zyxel Communications Corporation. All rights reserved.

Disclaimer

Zyxel does not assume any liability arising out of the application or use of any products, or software described herein. Neither does it convey any license under its patent rights nor the patent rights of others. Zyxel further reserves the right to make changes in any products described herein without notice. This publication is subject to change without notice.

Regulatory Notice and Statement

UNITED STATES of AMERICA



The following information applies if you use the product within USA area.

US Importer: Zyxel Communications, Inc, 1130 North Miller Street Anaheim, CA92806-2001, <https://www.zyxel.com/us/en/>

FCC EMC Statement

- The device complies with Part 15 of FCC rules. Operation is subject to the following two conditions:
 - (1) This device may not cause harmful interference, and
 - (2) This device must accept any interference received, including interference that may cause undesired operation.
- Changes or modifications not expressly approved by the party responsible for compliance could void the user's authority to operate the device.
- This product has been tested and complies with the specifications for a Class B digital device, pursuant to Part 15 of the FCC Rules. These limits are designed to provide reasonable protection against harmful interference in a residential installation. This device generates, uses, and can radiate radio frequency energy and, if not installed and used according to the instructions, may cause harmful interference to radio communications. However, there is no guarantee that interference will not occur in a particular installation.
- If this device does cause harmful interference to radio or television reception, which is found by turning the device off and on, the user is encouraged to try to correct the interference by one or more of the following measures:
 - Reorient or relocate the receiving antenna
 - Increase the separation between the devices
 - Connect the equipment to an outlet other than the receiver's
 - Consult a dealer or an experienced radio/TV technician for assistance

The following information applies if you use the product with RF function within USA area.

FCC Radiation Exposure Statement

- This device complies with FCC RF radiation exposure limits set forth for an uncontrolled environment.
- This transmitter must be at least 20 cm from the user and must not be co-located or operating in conjunction with any other antenna or transmitter.
- Operation of this device is restricted to indoor use only, except for relevant user's manual mention that this device can be installed into the external environment.

EUROPEAN UNION



The following information applies if you use the product within the European Union.

Declaration of Conformity with Regard to EU Directive 2014/53/EU (Radio Equipment Directive, RED)

- Compliance information for wireless products relevant to the EU and other Countries following the EU Directive 2014/53/EU (RED). And this product may be used in all EU countries (and other countries following the EU Directive 2014/53/EU) without any limitation except for the countries mentioned below table;
- In the majority of the EU and other European countries, the 5GHz bands have been made available for the use of wireless local area networks (LANs). Later in this document you will find an overview of countries in which additional restrictions or requirements or both are applicable. The requirements for any country may evolve. Zyxel recommends that you check with the local authorities for the latest status of their national regulations for the 5GHz wireless LANs.
- If this device for operation in the band 5150-5350 MHz, it is for indoor use only.
- This equipment should be installed and operated with a minimum distance of 20cm between the radio equipment and your body.
- The maximum RF power operating for each band as follows:
 - the band 2,400 to 2,483.5 MHz is 99.54 mW,
 - the bands 5,150 MHz to 5,350 MHz is 175.79 mW,
 - the 5,470 MHz to 5,725 MHz is 874.98 mW.

Български (Bulgarian)	<p>С настоящото Zyxel декларира, че това оборудване е в съответствие със съществените изисквания и другите приложими разпоредбите на Директива 2014/53/ЕС.</p> <p>National Restrictions</p> <ul style="list-style-type: none"> • The Belgian Institute for Postal Services and Telecommunications (BIPT) must be notified of any outdoor wireless link having a range exceeding 300 meters. Please check http://www.bipt.be for more details. • Draadloze verbindingen voor buitengebruik en met een reikwijdte van meer dan 300 meter dienen aangemeld te worden bij het Belgisch Instituut voor postdiensten en telecommunicatie (BIPT). Zie http://www.bipt.be voor meer gegevens. • Les liaisons sans fil pour une utilisation en extérieur d'une distance supérieure à 300 mètres doivent être notifiées à l'Institut Belge des services Postaux et des Télécommunications (IBPT). Visitez http://www.ibpt.be pour de plus amples détails.
Español (Spanish)	<p>Por medio de la presente Zyxel declara que el equipo cumple con los requisitos esenciales y cualesquiera otras disposiciones aplicables o exigibles de la Directiva 2014/53/UE..</p>
Čeština (Czech)	<p>Zyxel tímto prohlašuje, že tento zařízení je ve shodě se základními požadavky a dalšími příslušnými ustanoveními směrnice 2014/53/EU.</p>
Dansk (Danish)	<p>Undertegnede Zyxel erklærer herved, at følgende udstyr overholder de væsentlige krav og øvrige relevante krav i direktiv 2014/53/EU.</p> <p>National Restrictions</p> <ul style="list-style-type: none"> • In Denmark, the band 5150 - 5350 MHz is also allowed for outdoor usage. • I Danmark må frekvensbåndet 5150 - 5350 også anvendes udendørs.
Deutsch (German)	<p>Hiermit erklärt Zyxel, dass sich das Gerät Ausstattung in Übereinstimmung mit den grundlegenden Anforderungen und den übrigen einschlägigen Bestimmungen der Richtlinie 2014/53/EU befindet.</p>
Eesti keel (Estonian)	<p>Käesolevaga kinnitab Zyxel seadme seadmed vastavust direktiivi 2014/53/EL põhinõuetele ja nimetatud direktiivist tulenevatele teistele asjakohastele sätetele.</p>
Ελληνικά (Greek)	<p>ΜΕ ΤΗΝ ΠΑΡΟΥΣΑ Zyxel ΔΗΛΩΝΕΙ ΟΤΙ ΕΞΟΠΛΙΣΜΟΣ ΣΥΜΜΟΡΦΩΝΕΤΑΙ ΠΡΟΣ ΤΙΣ ΟΥΣΙΩΔΕΙΣ ΑΠΑΙΤΗΣΕΙΣ ΚΑΙ ΤΙΣ ΛΟΙΠΕΣ ΣΧΕΤΙΚΕΣ ΔΙΑΤΑΞΕΙΣ ΤΗΣ ΟΔΗΓΙΑΣ 2014/53/ΕΕ.</p>
English	<p>Hereby, Zyxel declares that this device is in compliance with the essential requirements and other relevant provisions of Directive 2014/53/EU.</p>
Français (French)	<p>Par la présente Zyxel déclare que l'appareil équipements est conforme aux exigences essentielles et aux autres dispositions pertinentes de la directive 2014/53/UE.</p>
Hrvatski (Croatian)	<p>Zyxel ovime izjavljuje da je radijska oprema tipa u skladu s Direktivom 2014/53/UE.</p>
Íslenska (Icelandic)	<p>Hér með lýsir, Zyxel því yfir að þessi búnaður er í samræmi við grunnkröfur og önnur viðeigandi ákvæði tilskipunar 2014/53/UE.</p>
Italiano (Italian)	<p>Con la presente Zyxel dichiara che questo attrezzatura è conforme ai requisiti essenziali ed alle altre disposizioni pertinenti stabilite dalla direttiva 2014/53/UE.</p> <p>National Restrictions</p> <ul style="list-style-type: none"> • This product meets the National Radio Interface and the requirements specified in the National Frequency Allocation Table for Italy. Unless this wireless LAN product is operating within the boundaries of the owner's property, its use requires a "general authorization." Please check http://www.sviluppoeconomico.gov.it/ for more details. • Questo prodotto è conforme alla specifiche di interfaccia Radio Nazionali e rispetta il Piano Nazionale di ripartizione delle frequenze in Italia. Se non viene installato all'interno del proprio fondo, l'utilizzo di prodotti Wireless LAN richiede una "Autorizzazione Generale". Consultare http://www.sviluppoeconomico.gov.it/ per maggiori dettagli.
Latviešu valoda (Latvian)	<p>Ar šo Zyxel deklarē, ka iekārtas atbilst Direktīvas 2014/53/ES būtiskajām prasībām un citiem ar to saistītajiem noteikumiem.</p> <p>National Restrictions</p> <ul style="list-style-type: none"> • The outdoor usage of the 2.4 GHz band requires an authorization from the Electronic Communications Office. Please check http://www.esd.lv for more details. • 2.4 GHz frekvenču joslas izmantošanai ārpus telpām nepieciešama atļauja no Elektronisko sakaru direkcijas. Vairāk informācijas: http://www.esd.lv.

Lietuvių kalba (Lithuanian)	Šiuo Zykel deklaruoja, kad šis įranga atitinka esminius reikalavimus ir kitas 2014/53/ES Direktyvos nuostatas.
Magyar (Hungarian)	Alulírott, Zykel nyilatkozom, hogy a berendezés megfelel a vonatkozó alapvető követelményeknek és az 2014/53/EU irányelv egyéb előírásainak.
Malti (Maltese)	Hawnhekk, Zykel, jiddikjara li dan tagħmir jikkonforma mal-ftiġijiet essenzjali u ma provvedimenti oħrajn rilevanti li hemm fid-Direttiva 2014/53/UE.
Nederlands (Dutch)	Hierbij verklaart Zykel dat het toestel uitrusting in overeenstemming is met de essentiële eisen en de andere relevante bepalingen van richtlijn 2014/53/EU.
Polski (Polish)	Niniejszym Zykel oświadcza, że sprzęt jest zgodny z zasadniczymi wymogami oraz pozostałymi stosownymi postanowieniami Dyrektywy 2014/53/UE.
Português (Portuguese)	Zykel declara que este equipamento está conforme com os requisitos essenciais e outras disposições da Directiva 2014/53/UE.
Română (Romanian)	Prin prezenta, Zykel declară că acest echipament este în conformitate cu cerințele esențiale și alte prevederi relevante ale Directivei 2014/53/UE.
Slovenčina (Slovak)	Zykel týmto vyhlasuje, že zariadenia spĺňa základné požiadavky a všetky príslušné ustanovenia Smernice 2014/53/EÚ.
Slovenščina (Slovene)	Zykel izjavlja, da je ta oprema v skladu z bistvenimi zahtevami in ostalimi relevantnimi določili direktive 2014/53/EU.
Suomi (Finnish)	Zykel vakuuttaa täten että laitteet tyyppinen laite on direktiivin 2014/53/EU oleellisten vaatimusten ja sitä koskevien direktiivin muiden ehtojen mukainen.
Svenska (Swedish)	Härmed intygar Zykel att denna utrustning står i överensstämmelse med de väsentliga egenskapskrav och övriga relevanta bestämmelser som framgår av direktiv 2014/53/EU.
Norsk (Norwegian)	Erklærer herved Zykel at dette utstyret er i samsvar med de grunnleggende kravene og andre relevante bestemmelser i direktiv 2014/53/EU.

Notes:

- Although Norway, Switzerland and Liechtenstein are not EU member states, the EU Directive 2014/53/EU has also been implemented in those countries.
- The regulatory limits for maximum output power are specified in EIRP. The EIRP level (in dBm) of a device can be calculated by adding the gain of the antenna used (specified in dBi) to the output power available at the connector (specified in dBm).

List of national codes

COUNTRY	ISO 3166 2 LETTER CODE	COUNTRY	ISO 3166 2 LETTER CODE
Austria	AT	Liechtenstein	LI
Belgium	BE	Lithuania	LT
Bulgaria	BG	Luxembourg	LU
Croatia	HR	Malta	MT
Cyprus	CY	Netherlands	NL
Czech Republic	CZ	Norway	NO
Denmark	DK	Poland	PL
Estonia	EE	Portugal	PT
Finland	FI	Romania	RO
France	FR	Serbia	RS
Germany	DE	Slovakia	SK
Greece	GR	Slovenia	SI
Hungary	HU	Spain	ES
Iceland	IS	Switzerland	CH
Ireland	IE	Sweden	SE
Italy	IT	Turkey	TR
Latvia	LV	United Kingdom	GB

Safety Warnings

- Do not use this product near water, for example, in a wet basement or near a swimming pool.
- Do not expose your device to dampness, dust or corrosive liquids.
- Do not store things on the device.
- Do not obstruct the device ventilation slots as insufficient airflow may harm your device. For example, do not place the device in an enclosed space such as a box or on a very soft surface such as a bed or sofa.

- Do not install, use, or service this device during a thunderstorm. There is a remote risk of electric shock from lightning.
- Connect ONLY suitable accessories to the device.
- Do not open the device or unit. Opening or removing covers can expose you to dangerous high voltage points or other risks.
- Only qualified service personnel should service or disassemble this device. Please contact your vendor for further information.
- Make sure to connect the cables to the correct ports.
- Place connecting cables carefully so that no one will step on them or stumble over them.
- Always disconnect all cables from this device before servicing or disassembling.
- Do not remove the plug and connect it to a power outlet by itself; always attach the plug to the power adaptor first before connecting it to a power outlet.
- Do not allow anything to rest on the power adaptor or cord and do NOT place the product where anyone can walk on the power adaptor or cord.
- Please use the provided or designated connection cables/power cables/ adaptors. Connect it to the right supply voltage (for example, 110V AC in North America or 230V AC in Europe). If the power adaptor or cord is damaged, it might cause electrocution. Remove it from the device and the power source, repairing the power adapter or cord is prohibited. Contact your local vendor to order a new one.
- Do not use the device outside, and make sure all the connections are indoors. There is a remote risk of electric shock from lightning.
- The following warning statements apply, where the disconnect device is not incorporated in the device or where the plug on the power supply cord is intended to serve as the disconnect device,
 - For permanently connected devices, a readily accessible disconnect device shall be incorporated external to the device;
 - For pluggable devices, the socket-outlet shall be installed near the device and shall be easily accessible.

Environment Statement

ErP (Energy-related Products)

Zyxel products put on the EU market in compliance with the requirement of the European Parliament and the Council published Directive 2009/125/EC establishing a framework for the setting of ecodesign requirements for energy-related products (recast), so called as "ErP Directive (Energy-related Products directive) as well as ecodesign requirement laid down in applicable implementing measures, power consumption has satisfied regulation requirements which are:

- Network standby power consumption < 8W, and/or
- Off mode power consumption < 0.5W, and/or
- Standby mode power consumption < 0.5W.

(Wireless settings, please refer to the chapter about wireless settings for more detail.)

European Union - Disposal and Recycling Information

The symbol below means that according to local regulations your product and/or its battery shall be disposed of separately from domestic waste. If this product is end of life, take it to a recycling station designated by local authorities. At the time of disposal, the separate collection of your product and/or its battery will help save natural resources and ensure that the environment is sustainable development.

Die folgende Symbol bedeutet, dass Ihr Produkt und/oder seine Batterie gemäß den örtlichen Bestimmungen getrennt vom Hausmüll entsorgt werden muss. Wenden Sie sich an eine Recyclingstation, wenn dieses Produkt das Ende seiner Lebensdauer erreicht hat. Zum Zeitpunkt der Entsorgung wird die getrennte Sammlung von Produkt und/oder seiner Batterie dazu beitragen, natürliche Ressourcen zu sparen und die Umwelt und die menschliche Gesundheit zu schützen.

El símbolo de abajo indica que según las regulaciones locales, su producto y/o su batería deberán depositarse como basura separada de la doméstica. Cuando este producto alcance el final de su vida útil, llévelo a un punto limpio. Cuando llegue el momento de desechar el producto, la recogida por separado éste y/o su batería ayudará a salvar los recursos naturales y a proteger la salud humana y medioambiental.

Le symbole ci-dessous signifie que selon les réglementations locales votre produit et/ou sa batterie doivent être éliminés séparément des ordures ménagères. Lorsque ce produit atteint sa fin de vie, amenez-le à un centre de recyclage. Au moment de la mise au rebut, la collecte séparée de votre produit et/ou de sa batterie aidera à économiser les ressources naturelles et protéger l'environnement et la santé humaine.

Il simbolo sotto significa che secondo i regolamenti locali il vostro prodotto e/o batteria deve essere smaltito separatamente dai rifiuti domestici. Quando questo prodotto raggiunge la fine della vita di servizio portarlo a una stazione di riciclaggio. Al momento dello smaltimento, la raccolta separata del vostro prodotto e/o della sua batteria aiuta a risparmiare risorse naturali e a proteggere l'ambiente e la salute umana.

Symbolen innebär att enligt lokal lagstiftning ska produkten och/eller dess batteri kastas separat från hushållsavfallet. När den här produkten når slutet av sin livslängd ska du ta den till en återvinningsstation. Vid tiden för kasseringen bidrar du till en bättre miljö och mänsklig hälsa genom att göra dig av med den på ett återvinningsställe.



台灣



以下訊息僅適用於產品具有無線功能且銷售至台灣地區

- 第十二條 經型式認證合格之低功率射頻電機，非經許可，公司，商號或使用者均不得擅自變更頻率、加大功率或變更原設計之特性及功能。
- 第十四條 低功率射頻電機之使用不得影響飛航安全及干擾合法通信；經發現有干擾現象時，應立即停用，並改善至無干擾時方得繼續使用。前項合法通信，指依電信法規定作業之無線電通信。低功率射頻電機須忍受合法通信或工業、科學及醫療用電波輻射性電機設備之干擾。
- 無線資訊傳輸設備須忍受合法通信之干擾且不得干擾合法通信；如造成干擾，應立即停用，俟無干擾之虞，始得繼續使用。
- 無線資訊傳輸設備的製造廠商應確保頻率穩定性，如依製造廠商使用手冊上所述正常操作，發射的信號應維持於操作頻帶中。
- 使用無線產品時，應避免影響附近雷達系統之操作。
- 高增益指向性天線只得應用於固定式點對點系統。

以下訊息僅適用於產品屬於專業安裝並銷售至台灣地區

- 本器材須經專業工程人員安裝及設定，始得設置使用，且不得直接販售給一般消費者。





安全警告 - 為了您的安全，請先閱讀以下警告及指示：

- 請勿將此產品接近水、火焰或放置在高溫的環境。
- 避免設備接觸：
 - 任何液體 - 切勿讓設備接觸水、雨水、高濕度、污水腐蝕性的液體或其他水份。
 - 灰塵及污物 - 切勿接觸灰塵、污物、沙土、食物或其他不合適的材料。
- 雷雨天氣時，不要安裝，使用或維修此設備。有遭受電擊的風險。
- 切勿重摔或撞擊設備，並勿使用不正確的電源變壓器。
- 若接上不正確的電源變壓器會有爆炸的風險。
- 請勿隨意更換產品內的電池。
- 如果更換不正確之電池型式，會有爆炸的風險，請依製造商說明書處理使用過之電池。
- 請將廢電池丟棄在適當的電器或電子設備回收處。
- 請勿將設備解體。
- 請勿阻礙設備的散熱孔，空氣對流不足將會造成設備損害。
- 請插在正確的電壓供給插座（如：北美 / 台灣電壓 110V AC，歐洲是 230V AC）。
- 假若電源變壓器或電源變壓器的纜線損壞，請從插座拔除，若您還繼續插電使用，會有觸電死亡的風險。
- 請勿試圖修理電源變壓器或電源變壓器的纜線，若有毀損，請直接聯絡您購買的店家，購買一個新的電源變壓器。
- 請勿將此設備安裝於室外，此設備僅適合放置於室內。
- 請勿隨一般垃圾丟棄。
- 請參閱產品背貼上的設備額定功率。
- 請參考產品型錄或是彩盒上的作業溫度。
- 產品沒有斷電裝置或者採用電源線的插頭視為斷電裝置的一部分，以下警語將適用：
 - 對永久連接之設備，在設備外部須安裝可觸及之斷電裝置；
 - 對插接式之設備，插座必須接近安裝之地點而且是易於觸及的。

About the Symbols

Various symbols are used in this product to ensure correct usage, to prevent danger to the user and others, and to prevent property damage. The meaning of these symbols are described below. It is important that you read these descriptions thoroughly and fully understand the contents.

Explanation of the Symbols

SYMBOL	EXPLANATION
	Alternating current (AC): AC is an electric current in which the flow of electric charge periodically reverses direction.
	Direct current (DC): DC is the unidirectional flow or movement of electric charge carriers.
	Earth; ground: A wiring terminal intended for connection of a Protective Earthing Conductor.
	Class II equipment: The method of protection against electric shock in the case of class II equipment is either double insulation or reinforced insulation.

Viewing Certifications

Go to <http://www.zyxel.com> to view this product's documentation and certifications.

Zyxel Limited Warranty

Zyxel warrants to the original end user (purchaser) that this product is free from any defects in material or workmanship for a specific period (the Warranty Period) from the date of purchase. The Warranty Period varies by region. Check with your vendor and/or the authorized Zyxel local distributor for details about the Warranty Period of this product. During the warranty period, and upon proof of purchase, should the product have indications of failure due to faulty workmanship and/or materials, Zyxel will, at its discretion, repair or replace the defective products or components without charge for either parts or labor, and to whatever extent it shall deem necessary to restore the product or components to proper operating condition. Any replacement will consist of a new or re-manufactured functionally equivalent product of equal or higher value, and will be solely at the discretion of Zyxel. This warranty shall not apply if the product has been modified, misused, tampered with, damaged by an act of God, or subjected to abnormal working conditions.

Note

Repair or replacement, as provided under this warranty, is the exclusive remedy of the purchaser. This warranty is in lieu of all other warranties, express or implied, including any implied warranty of merchantability or fitness for a particular use or purpose. Zyxel shall in no event be held liable for indirect or consequential damages of any kind to the purchaser.

To obtain the services of this warranty, contact your vendor. You may also refer to the warranty policy for the region in which you bought the device at http://www.zyxel.com/web/support_warranty_info.php.

Registration

Register your product online at www.zyxel.com to receive email notices of firmware upgrades and related information

Open Source Licenses

This product may contain in part some free software distributed under GPL license terms and/or GPL like licenses. Open source licenses are provided with the firmware package. You can download the latest firmware at www.zyxel.com. If you cannot find it there, contact your vendor or Zyxel Technical Support at support@zyxel.com.tw.

To obtain the source code covered under those Licenses, please contact your vendor or Zyxel Technical Support at support@zyxel.com.

Index

A

- Address Assignment [78](#)
- ALG [91](#)
 - and NAT [91](#)
 - and security policy [91](#)
- AP [11](#)
- AP Mode
 - menu [41](#)
 - status screen [41](#)
- AP+Bridge [11](#)
- Application Layer Gateway, see ALG

B

- Bridge/Repeater [11](#)

C

- certifications [177](#)
 - viewing [180](#)
- channel [103](#)
- contact information
 - customer support [147](#)
- copyright [175](#)
- customer support [147](#)

D

- DDNS
 - service providers [127, 129](#)
- DHCP server [114](#)
- Digital Living Network Alliance [56](#)
- disclaimer [175](#)
- DLNA [56](#)
 - indexing [73](#)

- overview [72](#)
- rescan [73](#)
- DLNA-compliant client [56](#)
- DNS Server [78](#)
- Domain Name System. See DNS.
- DynDNS [127, 129](#)
- DynDNS see also DDNS [127, 129](#)

E

- encryption [104](#)
- ESSID [145](#)

F

- file sharing
 - access right [69, 71](#)
 - bandwidth [71](#)
 - FTP [69](#)
 - Samba [31, 33, 67](#)
 - user account [68, 70](#)
 - Windows Explorer [31, 33, 67](#)
 - work group [31, 33, 67](#)
- Firewall
 - guidelines [124](#)
 - ICMP packets [127](#)
- firewall
 - stateful inspection [123](#)
- FTP
 - ALG [91](#)

G

- General wireless LAN screen [106](#)
- Guest WLAN [104](#)
- Guest WLAN Bandwidth [105](#)

H

H.323
ALG [91](#)

I

IP Address [116](#)

L

LAN [113](#)
LAN overview [113](#)
LAN setup [113](#)
local (user) database [104](#)
Local Area Network [113](#)

M

MAC [108](#)
MAC address [78, 103](#)
 cloning [78](#)
MAC address filter [103](#)
MAC address filtering [108](#)
MAC filter [108](#)
managing the device
 good habits [12](#)
 using the web configurator. See web configurator.
 using the WPS. See WPS.
MBSSID [11](#)
Media access control [108](#)
media client [72](#)
media file [72, 73](#)
 type [73](#)
media server
 overview [72](#)
media file play [72](#)
mode [11](#)

N

NAT
 and ALG [91](#)

O

OpenVPN Client [65](#)
OpenVPN Server [61](#)
operating mode [11](#)

P

Point-to-Point Protocol over Ethernet [82](#)
PPPoE [82](#)
 dial-up connection

Q

Quality of Service (QoS) [110](#)

R

RADIUS server [104](#)
Reset button [13](#)
Reset the device [13](#)
Router Mode
 status screen [36](#)

S

Samba [57](#)
Scheduling [112](#)
security policy
 and ALG [91](#)
Service Set [107](#)
Service Set IDentification [107](#)
Service Set IDentity. See SSID.

SIP
 ALG [91](#)
SSID [103, 107](#)
stateful inspection firewall [123](#)
Status [36](#)
Subnet Mask [116](#)
System General Setup [133](#)
System restart [137](#)
 overview [103](#)
 type [103](#)
wireless security [145](#)
Wireless tutorial [42](#)
WLAN button [13](#)
work group [56](#)
 name [56](#)
 Windows [56](#)
WPS [12](#)

U

user authentication [104](#)
 local (user) database [104](#)
 RADIUS server [104](#)

V

VoIP pass through
 see also ALG

W

WAN (Wide Area Network) [77](#)
WAN MAC address [78](#)
warranty [180](#)
 note [180](#)
Web Configurator
 how to access [27](#)
web configurator [12](#)
wireless channel [145](#)
wireless LAN [145](#)
wireless LAN scheduling [112](#)
Wireless network
 basic guidelines [102](#)
 channel [103](#)
 encryption [104](#)
 example [102](#)
 MAC address filter [103](#)
 overview [102](#)
 security [103](#)
 SSID [103](#)
Wireless security [103](#)