

Canon

PowerShot **PICK**
PowerShot **PX**



Advanced Guide

This manual is for app Ver.1.1.0 or later with firmware Ver. 1.1.0 or later installed.

E

Contents

Introducing the Camera.	4
Common Camera Operations.	5
Introduction.	9
Package Contents.	10
Instruction Manuals.	11
About This Guide.	12
Compatible Cards.	14
Safety Instructions.	15
Handling Precautions.	18
Part Names.	20
Dedicated App.	21
Camera Basics.	23
Charging the Camera.	24
Inserting/Removing Cards.	25
Positioning the Camera.	28
Turning on the Power.	30
Connecting to Smartphones, Disconnecting.	31
Indicator Display.	38
Shooting.	40
Shooting Automatically.	41
Shooting With Voice Commands.	44
Shooting Remotely.	48
Viewing Images.	54
Viewing Images.	55
Viewing Images With Specific People.	58
Viewing Recommended Images.	60
Saving/Deleting Images.	61
Saving Images to Smartphones/Deleting Images.	62
Saving Images to Computers.	66
Main App Screens.	68

Home Screen.	69
Playback Screen.	71
Shooting Screen.	72
Highlights Screen (iOS Only).	73
Settings Screen.	74
Other Functions.	77
Setting Up Auto Shooting.	78
Registering Information About People.	79
Specifying People to Shoot More Often.	90
Geotagging Images as You Shoot.	92
Creating Highlights (iOS Only).	95
Changing the Aspect Ratio.	100
Changing the Video Recording Quality.	102
Changing Camera Sound Settings.	105
Changing the Camera Nickname.	107
Changing Auto Image Deletion Settings.	109
Restoring Default Settings.	111
Checking Network Settings.	115
Using as a Webcam.	117
Checking Messages from the App.	124
Responding to Error Messages.	125
Other Information.	128
Reference.	131
Troubleshooting Guide.	132
Security.	137
Specifications.	138
Before Disposal.	144
Trademarks and Licensing.	146

Introducing the Camera

This product can automatically track detected people to shoot still photos or record movies. You can also control the camera with voice commands and shoot remotely from a smartphone.

Captured images can be viewed and saved using the dedicated app Connect App for Mini PTZ Cam installed on a smartphone.

Common Camera Operations

Shooting

Shoot in auto mode

- [Shooting Automatically](#)

Shoot by speaking to the camera

- [Shooting With Voice Commands](#)

Shoot remotely

- [Shooting Remotely](#)

Viewing Images

View images

- [Viewing Images](#)

View images with specific people

- [Viewing Images With Specific People](#)

View images recommended by the camera

- [Viewing Recommended Images](#)

Saving Images

Save images to smartphones

- [Saving Images to Smartphones/Deleting Images](#)

Save images to computers

- [Using the Interface Cable](#)
- [Using a Card Reader](#)

Other Functions

Register people to shoot more often

- [Registering Information About People](#)
- [Specifying People to Shoot More Often](#)

Tag images with the shooting location

- [Geotagging Images as You Shoot](#)

Create highlights (iOS only)

- [Creating Highlights \(iOS Only\)](#)

Introduction

Before starting to shoot, be sure to read the following

To avoid shooting problems and accidents, first read the [Safety Instructions](#) and [Handling Precautions](#). Also read this Advanced Guide carefully to ensure correct use.

Take some test shots, and understand about product liability

After shooting, play images back and check whether they have been properly recorded. If the camera or memory card is faulty and the images cannot be recorded or downloaded to a computer, Canon cannot be held liable for any loss or inconvenience caused.

Copyrights

Unauthorized public use of images captured with the camera that include copyrighted subjects may be prohibited by law. Also be aware that certain public performances, exhibitions, etc. may prohibit photography even for private enjoyment.

Firmware version

Update the firmware by downloading the latest version from the Canon website.

Connecting other devices

Use the included interface cable or a Canon cable when connecting the camera to a computer or other device. The cable should not exceed 2.5 m / 8.2 ft.

- [Package Contents](#)
- [Instruction Manuals](#)
- [About This Guide](#)
- [Compatible Cards](#)
- [Safety Instructions](#)
- [Handling Precautions](#)
- [Part Names](#)
- [Dedicated App](#)

Package Contents

Before use, make sure the following items are included in the package. If anything is missing, contact your dealer.



Camera



Interface Cable

- A memory card (📁) is not included.
- Be careful not to lose any of these items.

⚠ Caution

- The transmission rate with the included interface cable is equivalent to Hi-Speed USB (USB 2.0).
- Keep the sticker that is on an inner flap of the box the camera is packaged in. You may need the SSID and password on the sticker when connecting the camera to a smartphone (📱).

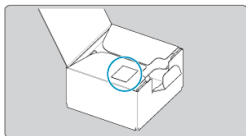



The instruction manuals provide setup instructions and are included with the camera.

- **Advanced Guide**

Complete instructions are provided in this Advanced Guide.
For the latest Advanced Guide, visit the following website.

<https://cam.start.canon/C009/>



- **Connect App for Mini PTZ Cam User Guide**

Basic instructions for the dedicated app Connect App for Mini PTZ Cam (📱) are provided in the Connect App for Mini PTZ Cam User Guide, accessible from within the app.

See [Other Settings](#) for instructions on displaying the Connect App for Mini PTZ Cam User Guide.





About This Guide

[Icons in This Guide](#)

[Basic Assumptions for Operational Instructions and Sample Photos](#)

Icons in This Guide

- Button and app icons are used in descriptions of controls and setting positions.

	Links to pages with related topics.
	Warning to prevent shooting problems.
	Supplemental information.
	Tips or advice for better shooting.

Basic Assumptions for Operational Instructions and Sample Photos

- Instructions apply to the camera with the power on (🔌).
- Instructions in this guide apply to the app under default settings.
- It is assumed that the camera is connected to the dedicated app Connect App for Mini PTZ Cam.
- Sample photos in this guide are only for illustration.

Compatible Cards

In this guide, all supported memory cards are simply referred to as “the card.”

The following cards can be used with the camera, and you can choose a suitable capacity for how you will shoot. **If the card is new or was previously formatted (initialized) by another camera or computer, format the card with the dedicated app Connect App for Mini PTZ Cam, installed on a smartphone (📱).**

- **microSD / microSDHC / microSDXC memory cards**

- * SD speed class compatible.

- * UHS-I compatible.



Note

- Consider using a high-capacity card, because many images may be captured in auto shooting. As a guideline, an hour of auto shooting (when set to [Active]) may capture approx. 8 GB of images.

Cards That Can Record Movies

When recording movies, use a card with ample performance (fast enough writing and reading speeds) for the movie recording size (📱).

Safety Instructions

Be sure to read these instructions in order to operate the product safely.
Follow these instructions to prevent injury or harm to the operator of the product or others.



WARNING

Denotes the risk of serious injury or death.

- Keep the product out of the reach of young children.

The parts or provided items of cameras or accessories are dangerous if swallowed. If swallowed, seek immediate medical assistance.

- Use only power sources specified in this instruction manual for use with the product.
- Do not disassemble or modify the product.
- Do not expose the product to strong shocks or vibration.
- Do not touch any exposed internal parts.
- Stop using the product in any case of unusual circumstances such as the presence of smoke or a strange smell.
- Do not use organic solvents such as alcohol, benzine or paint thinner to clean the product.
- Do not get the product wet. Do not insert foreign objects or liquids into the product.
- Do not use the product where flammable gases may be present.

This may cause electric shock, explosion or fire.

- Do not touch the product connected to a power outlet during lightning storms.

This may cause electric shock.

- Observe the following instructions when using a battery charger or AC adapter.
 - Periodically remove any dust buildup from the power plug and power outlet using a dry cloth.
 - Do not plug in or unplug the product with wet hands.
 - Do not use the product if the power plug is not fully inserted into the power outlet.
 - Do not expose the power plug and terminals to dirt or let them come into contact with metallic pins or other metal objects.
 - Do not touch the battery charger or AC adapter connected to a power outlet during lightning storms.
- Do not place heavy objects on the power cord. Do not damage, break or modify the power cord.
- Do not wrap the product in cloth or other materials when in use or shortly after use when the product is still warm in temperature.
- Do not unplug the product by pulling the power cord.
- Do not leave the product connected to a power source for long periods of time.
- Do not charge batteries/battery packs at temperatures outside the range of 5 - 40 °C (41 - 104 °F).

This may cause electric shock, explosion or fire.

- Do not allow the product to maintain contact with the same area of skin for extended periods of time during use.

This may result in low-temperature contact burns, including skin redness and blistering, even if the product does not feel hot. The use of a tripod or similar equipment is recommended when using the product in hot places and for people with circulation problems or less sensitive skin.

- Follow any indications to turn off the product in places where its use is forbidden. Not doing so may cause other equipment to malfunction due to the effect of electromagnetic waves and even result in accidents.



Cautions

Follow the cautions below. Otherwise physical injury or property damage may result.

- Do not leave the product in places exposed to extremely high or low temperatures. The product may become extremely hot/cold and cause burns or injury when touched.

- Do not apply strong pressure on the lens or allow an object to hit it.

This may cause injury or damage to the product.

- Do not touch any parts inside the product.

This may cause injury.

- If any abnormal skin reaction or irritation occurs during or following the use of this product, refrain from further use and get medical advice/attention.

Handling Precautions

Camera care

- This camera is a precision instrument. Do not drop it or subject it to physical shock.
- The camera is not waterproof and cannot be used underwater.
- Use a blower brush to remove dust from the dome cover.
- Wipe off any smudges or fingerprints on the dome cover with a commercially available eyeglass cloth (microfiber). After cleaning, take some shots to make sure they are not blurry from smudges.
- If water gets on the camera, wipe it off with a dry and clean cloth. If dirt, dust, or salt gets on the camera, wipe it off with a clean, well-wrung wet cloth.
- Using the camera in dusty or dirty locations may lead to damage.
- Cleaning the camera after use is recommended. Allowing dirt, dust, water, or salt to remain on the camera may cause a malfunction.
- If you accidentally drop the camera into water or are concerned that moisture (water), dirt, dust, or salt may have gotten inside it, promptly consult the nearest Canon Service Center.
- Never leave the camera near anything having a strong magnetic field such as a magnet or electric motor. Also, avoid using or leaving the camera near anything emitting strong radio waves, such as a large antenna. Strong magnetic fields can cause camera malfunction or destroy image data.
- Do not leave the camera in excessive heat, such as in a car in direct sunlight. High temperatures can cause the camera to malfunction.
- The camera contains precision electronic circuitry. Never attempt to disassemble the camera yourself.
- Condensation may form on the camera or internal parts if you bring the camera somewhere much hotter or colder. To prevent condensation, seal the camera in a plastic bag before bringing it where the temperature is much different, and then let it adjust to the temperature before removing it from the bag.
- If condensation forms on the camera, to avoid damage, do not use the camera or remove the card. Turn the camera off and wait until the moisture has fully evaporated before resuming use. Even after the camera is completely dry, if it is still internally cold, do not remove the card until the camera has adjusted to the ambient temperature.
- Condensation may form inside the dome cover if you bring the camera somewhere humid. Keep the camera off until the moisture has evaporated before use.
- If the camera will not be used for an extended period, store it in a cool, dry, well-ventilated location. Check operation occasionally while it is being stored.
- Avoid storing the camera where there are chemicals that result in rust and corrosion such as in a chemical lab.
- If the camera has not been used for an extended period, test all its functions before using it. If you have not used the camera for some time or if there is an important shoot such as a foreign trip coming up, have the camera checked by your nearest Canon Service Center or check the camera yourself and make sure it is working properly.
- If there is a bright light source inside or outside the image area, ghosting may occur.

Cards

To protect the card and its recorded data, note the following:

- Do not drop, bend, or wet the card. Do not subject it to excessive force, physical shock, or vibration.
- Do not touch the card's electronic contacts with your fingers or anything metallic.
- Do not affix any stickers, etc. on the card.
- Do not store or use the card near anything that has a strong magnetic field, such as a television, speakers, or magnets. Also avoid places prone to having static electricity.
- Do not leave the card in direct sunlight or near a heat source.
- Store the card in a case.
- Do not store the card in hot, dusty, or humid locations.

Part Names

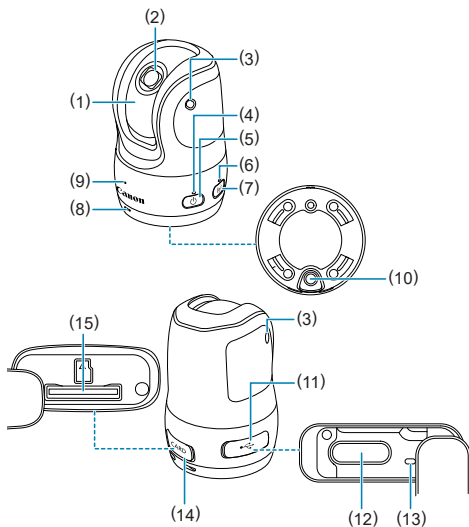

- | | |
|------|--|
| (1) | Dome cover |
| (2) | Shooting lens |
| (3) | Microphone |
| (4) | Power indicator |
| (5) | $\langle \text{Power} \rangle$ Power button |
| (6) | Communication indicator |
| (7) | $\langle \text{Wireless} \rangle$ Wireless communication button |
| (8) | Speaker |
| (9) | Status indicator |
| (10) | Accessory socket |
| (11) | Terminal cover |
| (12) | $\langle \text{Digital} \rangle$ Digital terminal |
| (13) | Charging indicator |
| (14) | $\langle \text{CARD} \rangle$ Card slot cover |
| (15) | $\langle \text{Card} \rangle$ Card slot |

Dedicated App

Connect App for Mini PTZ Cam is a dedicated app for controlling the camera. By establishing a Wi-Fi connection (hereafter, "connection") between the camera and a smartphone or tablet (collectively referred to as "smartphones"), you can control the camera remotely and view captured images.

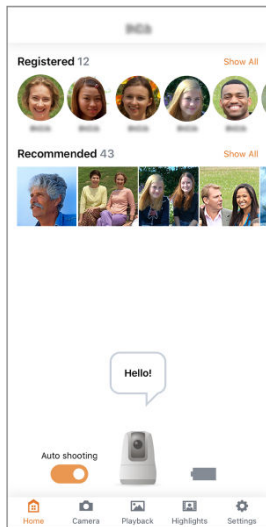

- Use of smartphones supporting Bluetooth low energy technology (hereafter, "Bluetooth") is recommended.

- Connect App for Mini PTZ Cam can be downloaded for free from Google Play or the App Store. You can also access Google Play or the App Store from the Advanced Guide website ([🔗](#)).
- For detailed Connect App for Mini PTZ Cam instructions, refer to the Connect App for Mini PTZ Cam User Guide, accessible from within the app.



Note

- Use the latest version of the smartphone OS.
- For details on OS versions that Connect App for Mini PTZ Cam can be used in, check the app download site.
- Sample screens and other details in this guide may not match the actual user interface elements after camera firmware updates or updates to Connect App for Mini PTZ Cam, Android, or iOS.

Camera Basics

This chapter describes how to prepare for shooting and provides basic camera information and operations.

Caution

- Do not rotate the camera's moving parts by hand. Doing so may cause a malfunction.

- [Charging the Camera](#)
- [Inserting/Removing Cards](#)
- [Positioning the Camera](#)
- [Turning on the Power](#)
- [Connecting to Smartphones, Disconnecting](#)
- [Indicator Display](#)

Charging the Camera

1. Charge the camera.

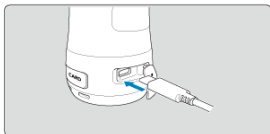

- Charge the camera before use.
 - Charge the camera by connecting the camera's Digital terminal to a power adapter (sold separately).
 - After charging begins, the charging indicator blinks slowly in orange.
 - The charging indicator is lit in orange after charging is finished.
- **Charging the camera when it is fully depleted takes approx. 1 hr. and 59 min. at room temperature (23°C/73°F).** Charging time varies greatly depending on ambient temperature and remaining capacity.
 - For safety, charging in low temperatures (5–10°C/41–50°F) takes longer.
 - The camera can also be used while plugged in for power. When receiving power, do not allow the terminal cover to come in contact with moving parts of the camera.



Note

- For charging and powering the camera, an optional USB Power Adapter PD-E1 is recommended. Some commercially available power adapters (USB Type-C Power Delivery, with an output voltage/current of at least 9V DC/2A) have also been confirmed to work with the camera. For details, check the Canon website.
- **Upon purchase, the battery is not fully charged.**
Charge the battery before use.
 - **Charge the battery on the day before or on the day it is to be used.**
Charged batteries gradually lose their charge, even when they are not used.
 - **Use the camera where the temperature is 0–40°C (32–104°F).**
For optimal camera performance, use where the ambient temperature is 10–30°C (50–86°F). Lower temperatures may temporarily reduce the performance and life of the built-in battery.

Inserting/Removing Cards

 [Insertion](#)

 [Removal](#)

Caution

- Use of memory cards other than microSD / microSDHC / microSDXC cards is not supported.

Always turn the camera off before inserting or removing cards.

Insertion

1. Open the cover.

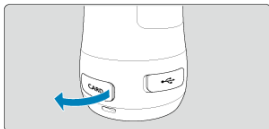

2. Insert the card.



- Insert the card with the label face-up. **Inserting cards the wrong way may damage the camera.**

3. Close the cover.



1. Open the cover.

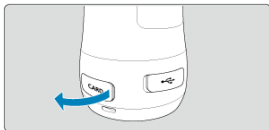

2. Remove the card.

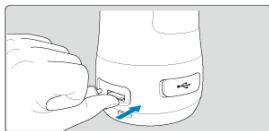

- Press the card in to eject it.
- Pull the card straight out, then close the cover.

! Caution

- **To avoid corrupting image data or damaging cards or the camera, never do any of the following while the status indicator is lit or blinking.**
 - Removing the card
 - Shaking or striking the camera
- If a card-related error message is displayed in the app, turn off the camera before removing the card. If the error persists, use a different card. If you can transfer images on the card to a computer, transfer all the images and then format the card with the camera (🔗). The card may then return to normal.

📄 Note

- File numbering may not start from 0001 if there are already images on the card.

Positioning the Camera

Place the camera on a flat, stable surface.

For outdoor use, avoid direct sunlight, and consider placing the camera in the shade.

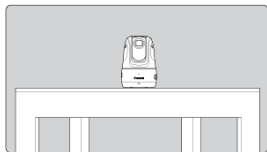

Using the accessory socket on the bottom of the camera, you can attach it to a tripod or other holder.

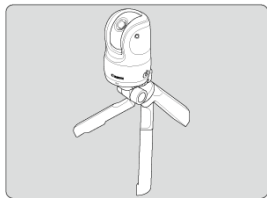

The shooting range covered by the camera is shown below. To make it easier for the camera to acquire subjects when shooting, avoid having any obstructions between the camera and people.

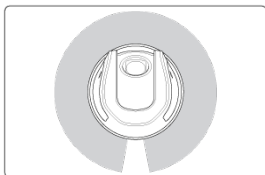

Approx. 340°

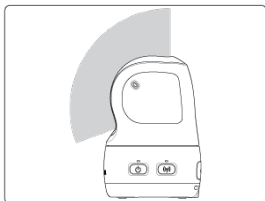

Approx. 110°

Turning on the Power



- To turn the camera on, press the <power> button. Press it again to turn the camera off.

Caution

- When the power indicator is lit in red, the battery level is low. Either supply power to use the camera or turn it off and charge it.

Connecting to Smartphones, Disconnecting

- [☑ Connecting to Smartphones](#)
- [☑ Turning Off Wi-Fi and Closing the App](#)
- [☑ Reconnecting](#)

⚠ Caution

Important

- Note that Canon cannot be held liable for any loss or damage caused by erroneous network settings when using the camera. In addition, Canon cannot be held liable for any other loss or damage caused by use of the camera. Take security measures that you deem necessary when using a network, at your discretion. Canon cannot be held liable for any loss or damage caused by unauthorized access or other security breaches.

Connecting to Smartphones

Before you start shooting with the camera, you will need to connect to a smartphone. Connect to a smartphone as follows.

1. Turn the camera on.

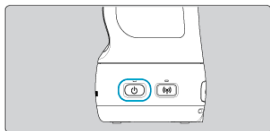

2. Start Connect App for Mini PTZ Cam.

- Follow the instructions displayed to establish a connection with the camera.
- After the devices are connected, the home screen of Connect App for Mini PTZ Cam appears, and the camera's communication indicator lights up.

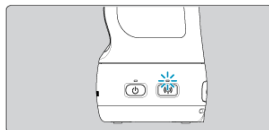
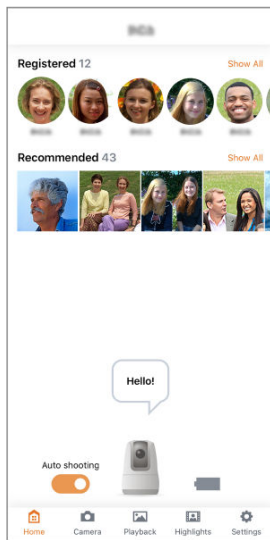



Note

- To resolve connection problems, see [Problems with Wireless Features](#) in the Troubleshooting Guide.

Troubleshooting Pairing

If the devices cannot be paired, a message is displayed to use an SSID and password for pairing.

The SSID and password are indicated on a sticker on an inner flap of the box the camera was packaged in.

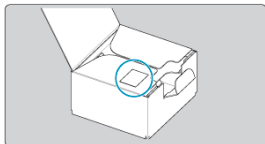

To pair the devices, follow the instructions and enter the SSID and password.

Turning Off Wi-Fi and Closing the App

1. Tap [⚙️ (Settings)].



2. Tap [Basic Camera Set.].

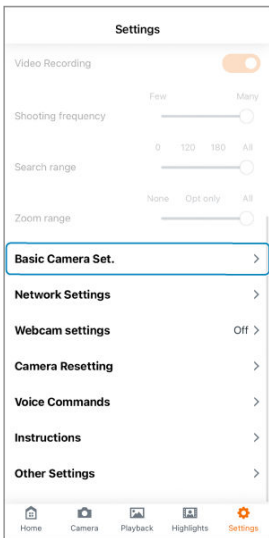

3. Tap [Wi-Fi off/close app].

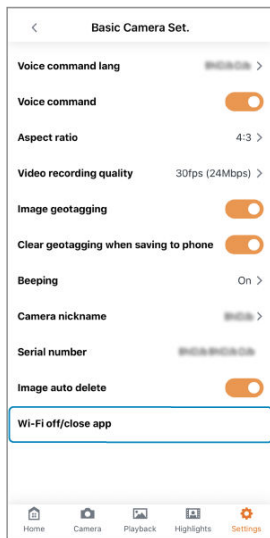

- To stop shooting, turn off the camera (🔒).

Reconnecting

1. Turn the camera on.
2. Start Connect App for Mini PTZ Cam.
 - Follow the instructions displayed to reconnect with the smartphone.



Note

- To resolve connection problems, see [Problems with Wireless Features](#) in the Troubleshooting Guide.

Indicator Display

Status indicator (red)



Enables you to check the status of shooting and see if any errors have occurred.

Indicator	Status
Off	Standby
Blinking once	Shooting still photos
On	Movie recording in progress
Blinking	An error has occurred

Caution

- An error has occurred if the status indicator is blinking. Check message from the app ([🔗](#)).

Power indicator (green/red)



Enables you to check the remaining battery level and the power source status.

Indicator	Status
Off	The battery is depleted, or the camera is off.
On	The camera is on. Green: Battery level high Red: Battery level low
Blinking	Auto shooting by voice command stopped, or connecting to a computer

Communication indicator (blue)



Enables you to check the status of smartphone connections.

Indicator	Status
Off	Connection or pairing not set up
Blinking once per second	Paired
Blinking once every six seconds	Ready to pair
Blinking once every three seconds	Ready for connection
On	Connected

Charging indicator (orange)

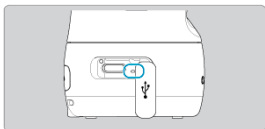

Enables you to check the status of charging or supplying power.

Indicator	Status
Off	No USB connection, or cannot be charged or powered on
Blinking slowly	Charging in progress, or receiving power
On	Charging finished
Blinking quickly	A charging error has occurred

Shooting

This chapter describes several methods of shooting you can use.

Caution

- Focusing may be difficult under these conditions:
 - Subjects with low contrast, such as a blue sky or flat surfaces in solid colors, or other cases when highlight or shadow details are clipped
 - Subjects in low light
 - Stripes or other patterns that only have horizontal contrast
 - Subjects with repetitive patterns (such as building windows or computer keyboards)
 - Fine lines and subject outlines
 - Under light sources with constantly changing brightness, colors, or patterns
 - Night scenes or points of light
 - Scenes with flickering, under fluorescent or LED lighting
 - Extremely small subjects
 - Subjects at the edge of the screen
 - Strongly backlit or reflective subjects (such as cars with highly reflective surfaces)
 - Near and distant subjects in AF points (such as animals in a cage)
 - Subjects that constantly move due to camera shake or subject blur
 - AF operations while subjects are quite out of focus

- [Shooting Automatically](#)
- [Shooting With Voice Commands](#)
- [Shooting Remotely](#)

Shooting Automatically

After you turn the camera on, it will look for people and automatically shoot still photos and record movies.

- First, pair the camera with a smartphone and establish a connection.
- After you have established a connection, automatic shooting is possible even without a connected smartphone, simply by turning on the camera.
- Automatic shooting stops when you turn the camera off.



Effective in these situations:

- Shooting kids at a campsite
- Covering a home party or other event

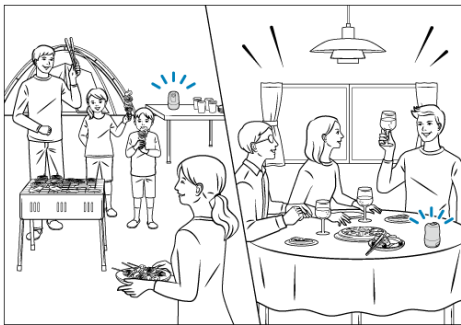

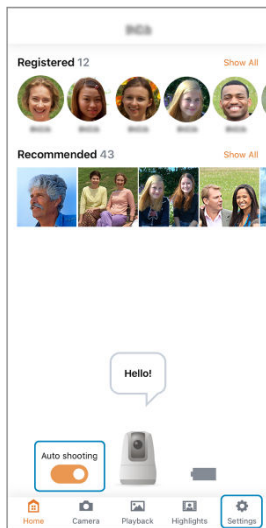

Settings for automatic shooting can be adjusted in the app.



- To stop auto shooting, turn off **[Auto shooting]** on the home screen.
- Tap **[Settings]** to adjust the priority of subjects, auto shooting parameters, and other settings (🔗).

Caution

- Depending on subject conditions, the camera may not shoot automatically.
 - If subjects are too far from the camera
 - If much of a subject's face is covered by a mask, hat, sunglasses, or other objects
- Movies are not recorded if you connect the camera and smartphone via Wi-Fi during auto shooting. These conditions are required in order for movies to be included in auto shooting.
 - The app has been moved to the background
 - You have tapped [ (**Settings**)] and closed the app by tapping [**Basic Camera Set.**], then [**Wi-Fi off/close app**]
- Less movie recording time may be available if the camera becomes hot during auto shooting.
- Movies may not be recorded if the camera becomes hot during auto shooting, even when you have set the auto shooting image ratio to include some movies.
- The camera may turn off automatically if it becomes hot during auto shooting.
- Images may be deleted during auto shooting if the camera determines that shooting has failed, even if the status indicator blinks once in still photo shooting or remains lit in movie recording.
- These actions will stop movie recording in progress during auto shooting and may delete the movie: connecting to a smartphone, using voice commands, or turning off the camera.
- The camera stores face images (face information) registered using Face ID. For this reason, after setting Face ID, be careful when giving the camera to others.
- When disposing of a camera or transferring it to another person after using Face ID, be sure to erase all information (registered faces, names, and birthdays) from the camera ().

Shooting With Voice Commands

You can control the camera during auto shooting by speaking the commands listed in [Voice Commands] to it.



⚠ Caution

- To use a voice command, start speaking within 5 seconds of calling out the camera.
- Some factors may prevent the camera from recognizing voice commands, such as the distance to the camera, ambient noise, or your way of speaking or the loudness of your voice.
- Movie recording started by a voice command will stop automatically in 2 min. Movie recording in progress during auto shooting will stop automatically when a voice command is detected.

Check available voice commands as follows.

1. Tap [**Settings**].



2. Tap [**Voice Commands**].

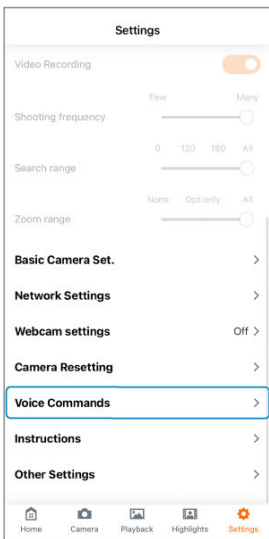

Caution

- The language of voice commands does not change if you change the smartphone language setting after starting the app. To change the voice command language, adjust [**Voice command lang**] in [**Basic Camera Set.**].
- The camera may turn off automatically if it becomes hot during movie recording started by a voice command.

Turn off voice commands as follows.

1. Tap [Basic Camera Set.].

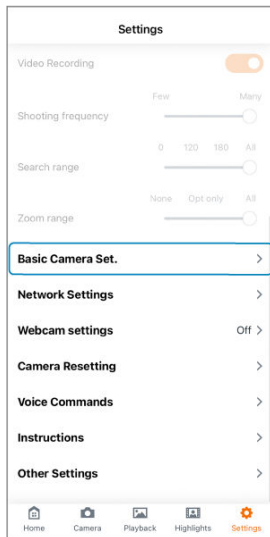

2. Turn off [Voice command].

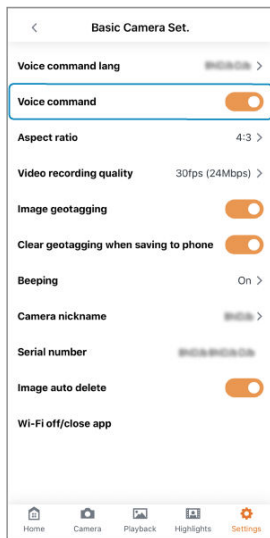

Shooting Remotely

Shoot remotely as you view the image on a smartphone. You can check the image as you shoot group photos, or you can check as you shoot subjects who are tracked automatically.

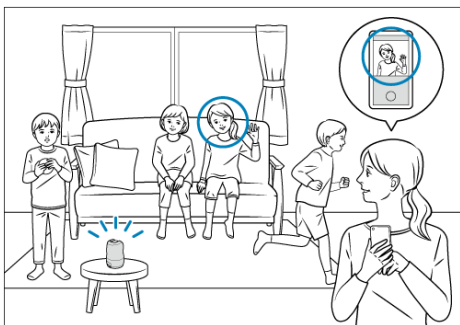

1. Tap [📷 (Camera)].



2. Tap [Video] or [Photo].

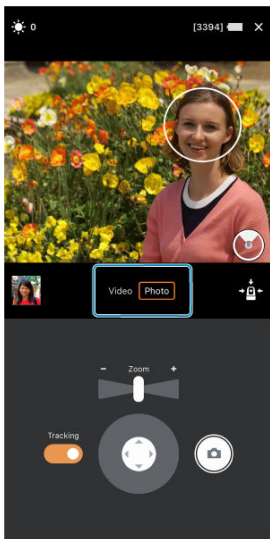

- When the camera detects a person, a white circle appears around their face, and tracking begins.
- Selecting **[Video]** as the shooting mode will show a gray frame around the recording area.

3. Set the camera direction and subject size.

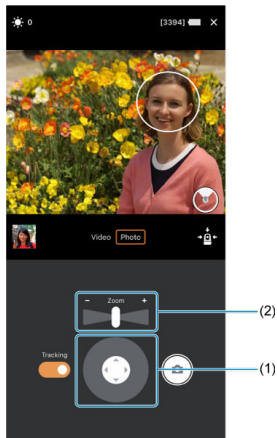

- Adjust the camera direction by using the camera control (1) or by dragging.
- Adjust the subject size by using the zoom control (2) or by pinching open or closed.

4. Tap the shooting button.



- The camera shoots.
- To stop movie recording, tap the shooting button (3) again.

! Caution

- A warning will be displayed if the camera becomes hot during remote movie recording. The camera may eventually turn off automatically if you continue using it this way.

📱 Note

- To adjust image brightness (exposure compensation), tap [☀️] (4).

To focus

Tap where you want to focus.

If you only wish to focus, turn off **[Tracking]**, and turn it on if you wish to focus and track the subject to keep the person in the angle of view.

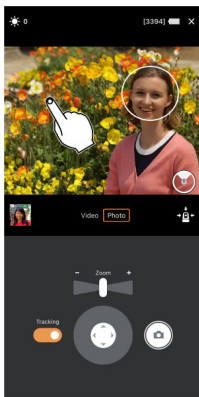

To track a different person

Tapping a subject to track changes the round frame from a dotted to a solid line, and tracking switches to the new subject.

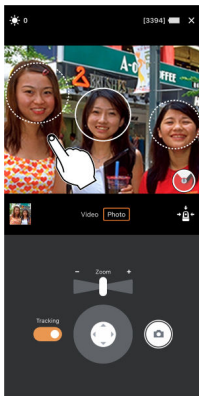

Viewing Images

This chapter describes how to view your captured still photos and movies.

- [Viewing Images](#)
- [Viewing Images With Specific People](#)
- [Viewing Recommended Images](#)

Viewing Images

[✔ Viewing Still Photos and Movies](#)

[✔ Viewing the Still Photo and Movie List](#)

Captured still photos and movies can be reviewed in Connect App for Mini PTZ Cam.

Caution

- It may take some time to display the playback and list screens when there are many images.

Viewing Still Photos and Movies

1. Tap [🖼️ (Playback)].



2. Tap an image thumbnail.

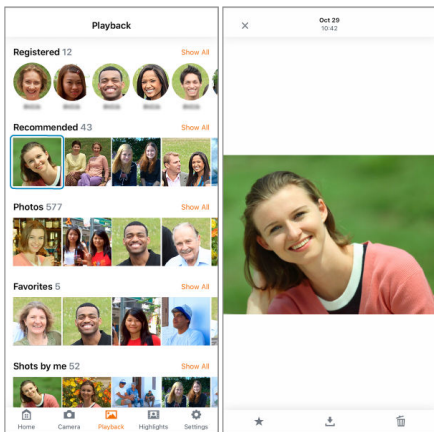

- A larger view of the image appears.
- To view the previous or next image, swipe right or left.

1. Tap [Show All].

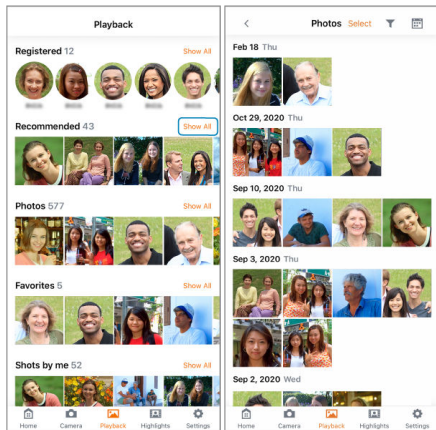

- A list of images appears.

2. Switch the display mode.

- Tap [📄] to switch to tiled display.
- For a larger view, tap an image thumbnail.

Viewing Images With Specific People

You can view images that include specific people registered on the camera.

1. In [Registered], tap the icon of a person whose images you want to view.

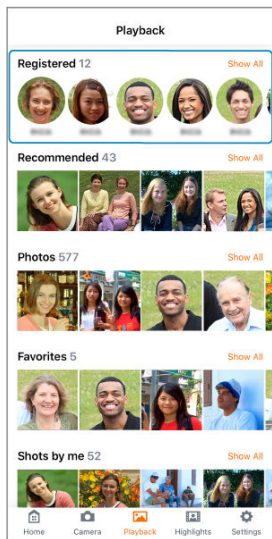

- Tap **[Show All]** to view a list of all registered people.

2. Tap an image thumbnail.

- A larger view of the image appears.

 **Caution**

- Images with people other than the registered person may be displayed.
- Depending on the environment of use, images that do include the registered person may not be displayed.

Viewing Recommended Images

From all images captured, you can view recommended images that are selected automatically.

1. In [Recommended], tap an image thumbnail you wish to view.

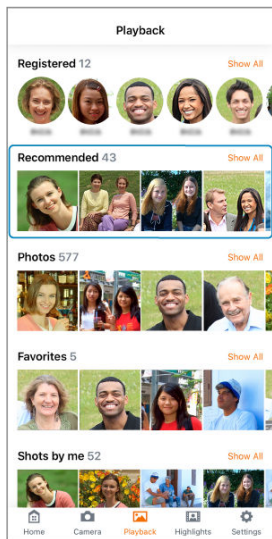

- Tap **[Show All]** to view a list of all recommended images.

Saving/Deleting Images

This chapter describes how to save or delete your captured images.

- [Saving Images to Smartphones/Deleting Images](#)
- [Saving Images to Computers](#)

Saving Images to Smartphones/Deleting Images

[Saving/Deleting Individual Images](#)

[Saving/Deleting Multiple Images at Once](#)

Caution



- Images saved to computers may not match those saved to smartphones, which are automatically straightened by the dedicated app.

Saving/Deleting Individual Images

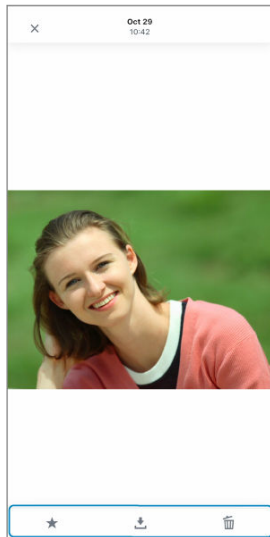
1. Display an image.



2. Save or delete the image.

- Tap [] to save the image to the smartphone.
- Tap [] to delete the image from the camera.
- Tap [] to register the image to **[Favorites]**.

1. Display a list of images.



- [Filter icon] is displayed when [Photo] or [Video] images are listed. Tap [Filter icon] to switch the images displayed.
- Tap [Select].

2. Select images.

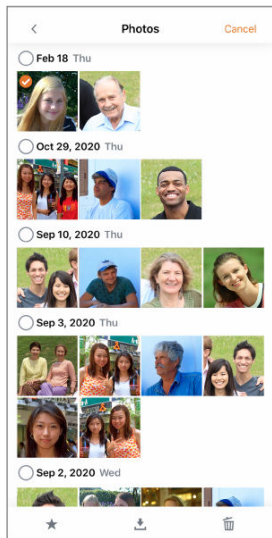

- Selected images are identified by a check mark.
- Flicking up or down will display a scroll bar at right. You can navigate quickly by tapping the scroll bar.
- Touch and hold to select multiple images. The first image you touch and hold becomes the initial image (starting point), and once you select the last image (ending point), all images between the starting and ending points are marked with a checkmark [✔].
- For a larger view, double-tap an image.

3. Save or delete the image.

- Tap [↓] to save the image to the smartphone.
- Tap [🗑] to delete the image from the camera.
- Tap [★] to register the image to **[Favorites]**.

Saving Images to Computers

[Using the Interface Cable](#)

[Using a Card Reader](#)

Captured images can also be imported to a computer.

Using the Interface Cable

- 1. Connect the camera to the computer.**
 - Use the included interface cable.
 - Insert the other end of the cable into the computer's USB terminal (Type-C).

- 2. Copy images in the DCIM folder of the camera (card) to the computer.**

1. Insert the card into the card reader.
2. Copy images in the card's DCIM folder to the computer.

Main App Screens

For details on features available on each screen of Connect App for Mini PTZ Cam instructions, refer to the Connect App for Mini PTZ Cam User Guide, accessible from within the app.

- [Home Screen](#)
- [Playback Screen](#)
- [Shooting Screen](#)
- [Highlights Screen \(iOS Only\)](#)
- [Settings Screen](#)

Home Screen

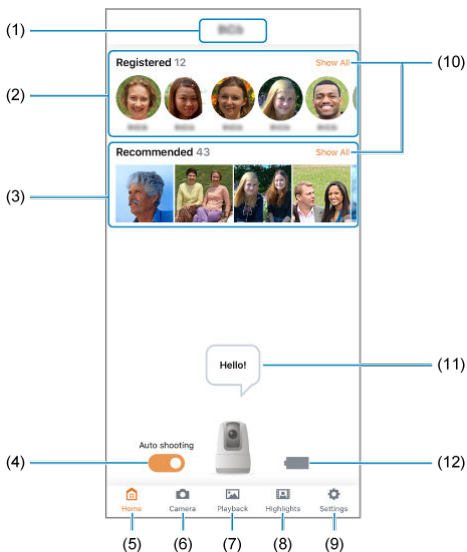





- (1) Shows the camera's nickname.
- (2) People who face the camera are registered automatically. You can also enter names for the people (👤).
- (3) Shows images recommended automatically, from all images captured.
- (4) Turn auto shooting mode on or off (🔘).
- (5) Switch to the home screen.
- (6) Switch to the shooting screen.
- (7) Switch to the playback screen.
- (8) Switch to the highlights screen (iOS only).
- (9) Switch to the settings screen.
- (10) Lists all images in the selected category (👤).
- (11) Shows messages from the camera.
- (12) Shows the camera's remaining battery level.



Note

Battery Level Indicator

- : Battery level high
- : Battery level medium
- : Battery level low
- : Receiving power (charging)
- : Receiving power (fully charged)

Playback Screen

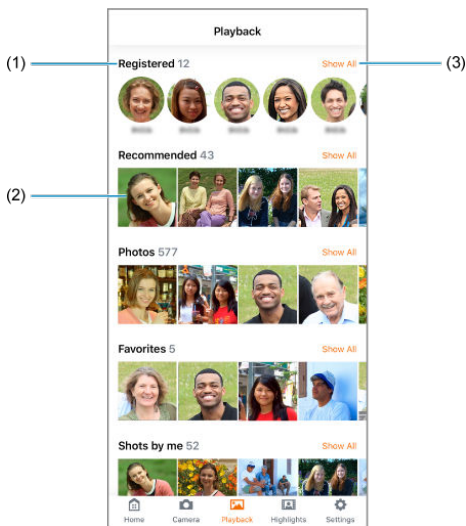

-
- (1) Images are grouped by category. The number of images is shown next to the category name.

 - (2) Tap a thumbnail in [**Registered**] to view a screen that lists photos for that person. Tap a thumbnail in another category to view individual images.

 - (3) Lists all images in the selected category (📁).

Shooting Screen

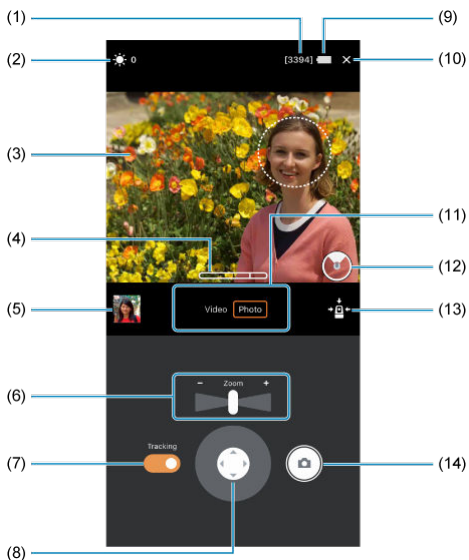

- (1) Available shots indicator
- (2) Exposure compensation indicator
- (3) Live view screen
- (4) Zoom bar
- (5) Thumbnail
- (6) Zoom control
- (7) **[Tracking]** on/off switch
- (8) Camera control
- (9) Camera battery level
- (10) Close button
- (11) Shooting mode buttons (Video/Photo)
- (12) Camera direction
- (13) Reset button for camera direction
- (14) Shooting button

Highlights Screen (iOS Only)

Highlights are created from this screen (🔗).

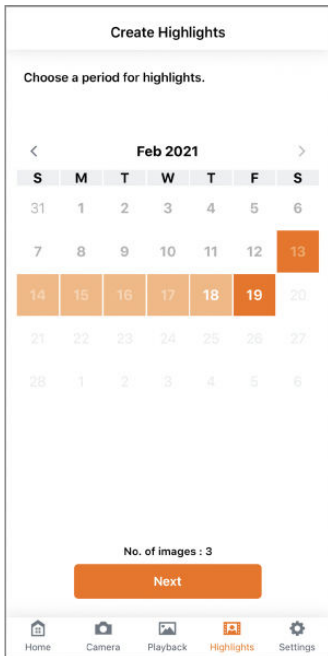

Settings Screen

Shooting priority settings

Specify to shoot certain people more than others (👤).

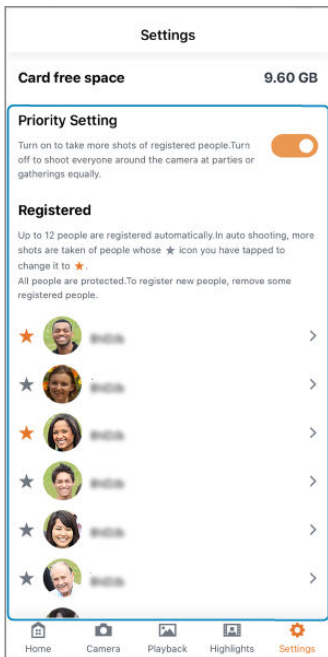

Auto shooting settings

Specify details for shooting automatically (🔒).

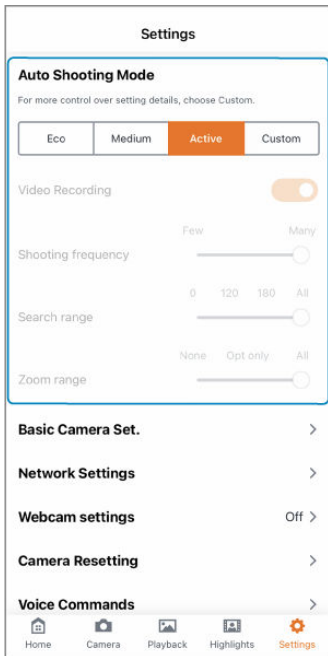

Other settings

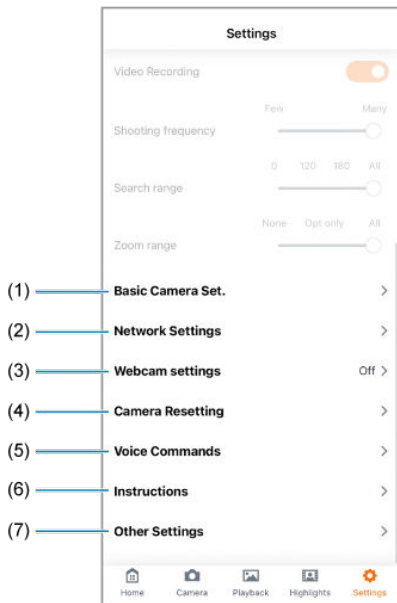

- (1) Change basic camera settings or check the camera serial number.
- (2) Check network settings (🔗).
- (3) Specify webcam settings (🔗).
- (4) Reset camera settings or format cards (🔗).
- (5) View a list of voice commands (🔗).
- (6) View the app instruction manual.
- (7) Check camera and app information, or update the camera firmware (🔗).

Other Functions

This chapter describes the main items that can be set in the app. For details, refer to the Connect App for Mini PTZ Cam User Guide, accessible from within the app.

- [Setting Up Auto Shooting](#)
- [Registering Information About People](#)
- [Specifying People to Shoot More Often](#)
- [Geotagging Images as You Shoot](#)
- [Creating Highlights \(iOS Only\)](#)
- [Changing the Aspect Ratio](#)
- [Changing the Video Recording Quality](#)
- [Changing Camera Sound Settings](#)
- [Changing the Camera Nickname](#)
- [Changing Auto Image Deletion Settings](#)
- [Restoring Default Settings](#)
- [Checking Network Settings](#)
- [Using as a Webcam](#)
- [Checking Messages from the App](#)
- [Responding to Error Messages](#)
- [Other Information](#)

Setting Up Auto Shooting

The auto shooting mode can be adjusted.

1. Access the settings screen.
2. Select an item in [Auto Shooting Mode].

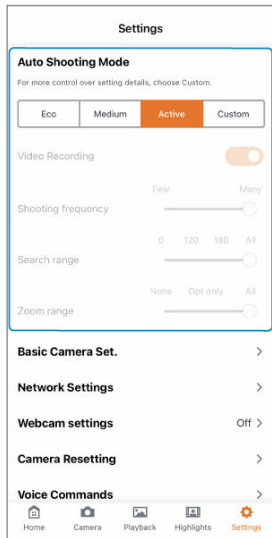

- Select [**Custom**] to adjust settings in greater detail.

Note

- To conserve battery power, set the [**Auto Shooting Mode**] item to [**Eco**] or [**Medium**].

Registering Information About People

 [Entering Information About People](#)

 [Removing Registered People](#)

 [Merging Registered People](#)

Up to 12 people recognized by the camera are automatically registered. Any new person recognized is registered after a currently registered but unprotected person is removed.

To protect registered people, enter information about them.

Caution

- Under the following conditions, people in captured images may not be registered:
 - If subjects are too far from the camera
 - If subjects are too close to the camera
 - If much of a subject's face is covered by a mask, hat, sunglasses, or other objects
 - When [**Priority Setting**] is turned off on the settings screen
 - If the shooting or settings screen is displayed in the app

Note

- It is easier for the camera to register subjects at a distance of 50–100 cm.

Entering Information About People

1. In [Registered], tap a person to enter information for.

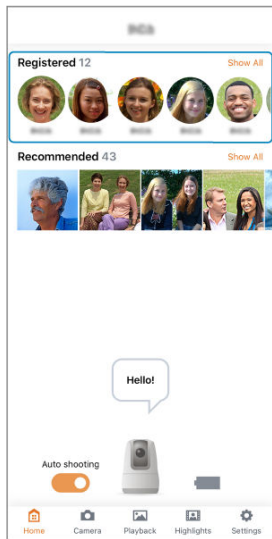

- Tap [Show All] to view a list of all registered people.

2. Tap [>].

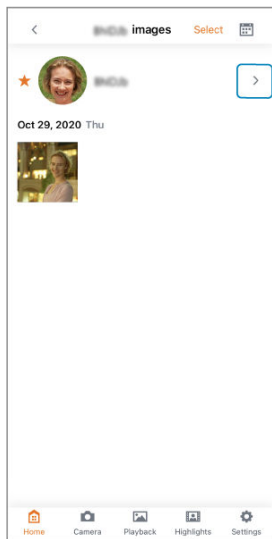

3. Enter the person's Name and Birthday.

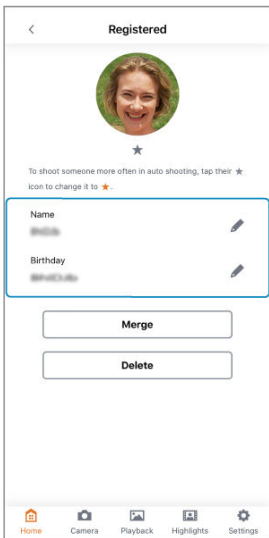

- After you enter the person's name or birthday, their information is protected.
- Protected information is not automatically removed, even when new people are recognized.

Note

- To prioritize a person in shooting, tap [★] to change it to orange (👉).

Removing Registered People

1. In [Registered], tap a person to remove.

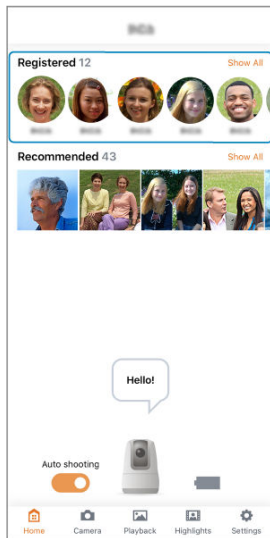

- Tap **[Show All]** to view a list of all registered people.

2. Tap [>].

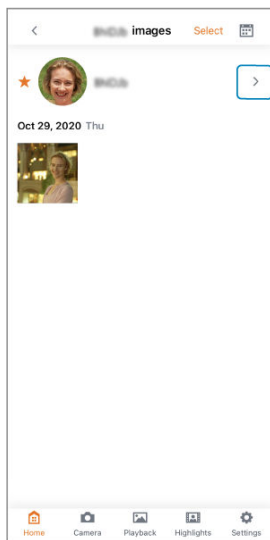

3. Tap [Delete].

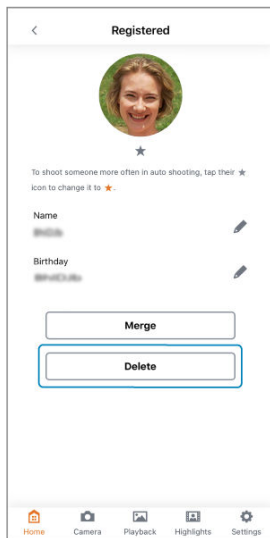

4. Tap [Yes].

Merging Registered People

If a person already registered is registered again as a different person, you can combine both records as being for the same person.

1. In [Registered], tap a person to merge.

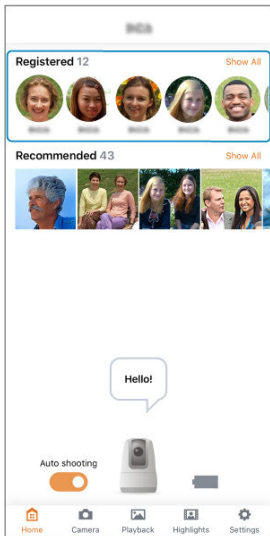

- Tap **[Show All]** to view a list of all registered people.

2. Tap [>].

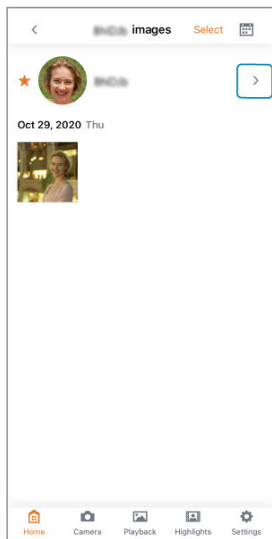

3. Tap [Merge].

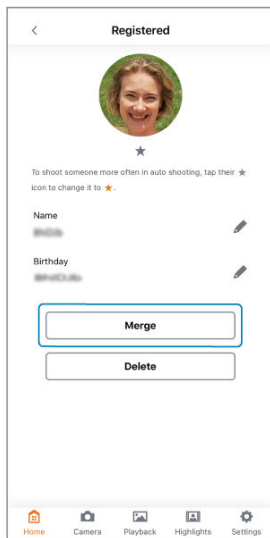

4. Tap a person to merge.

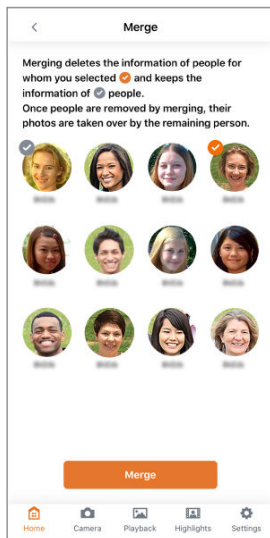

- Selected people are identified by a check mark.

5. Tap [Merge].

Specifying People to Shoot More Often

By setting a priority level for registered people, you can have the camera try to shoot them more often.

Effective in these situations:

- Taking more photos of a specific person at a birthday party
- On vacation, taking more photos of specific children

1. Access the settings screen.

2. Turn on [Priority Setting].

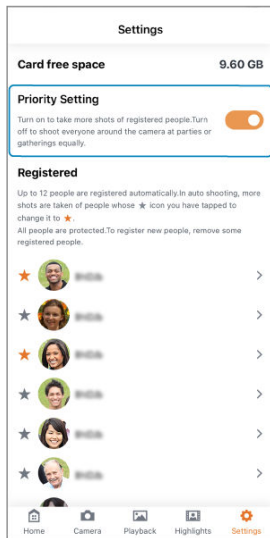

3. In [Registered], tap [★].

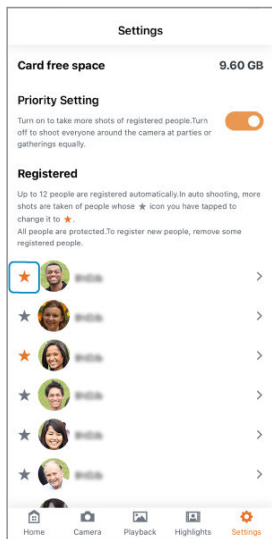

- [★] turns orange, and that person is prioritized in shooting.

⚠ Caution

- Setting a priority level for registered people protects their registered information. Protected information is not automatically removed, even when new people are recognized.

📌 Note

- More images may be captured automatically when you have set a priority level for registered people.
- Fewer images may be captured automatically when the camera cannot find people whose priority level you have set.

Geotagging Images as You Shoot

Captured images can be geotagged using GPS information (such as latitude, longitude, and elevation) from a smartphone.

On the smartphone, activate location services.

Caution

- Elevation is not as accurate as latitude or longitude, due to the nature of GPS.
- Shots may not be geotagged immediately after the camera is turned on.

Countries/regions permitting use of GPS functions

- Use of GPS features is restricted in some countries and regions, and illegal use may be punishable under national or local regulations. To avoid violating GPS regulations, visit the Canon website to check where use is allowed. Note that Canon cannot be held liable for any problems arising from use of GPS functions in other countries and regions.
 - Because the use of GPS may be restricted in some countries and regions, follow local laws and regulations where you will use the camera. Be particularly careful about using GPS functions outside your home country.
 - Be careful about using GPS functions where the operation of electronic devices is restricted.
 - Others may be able to locate or identify you by using location data in your geotagged still images or movies. Be careful when sharing these geotagged still images, movies, or GPS log files with others, such as when posting them online where many people can view them.

1. Access the settings screen.

2. Tap [Basic Camera Set.].

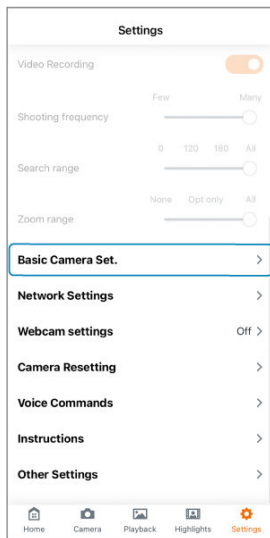

3. Turn on [Image geotagging].

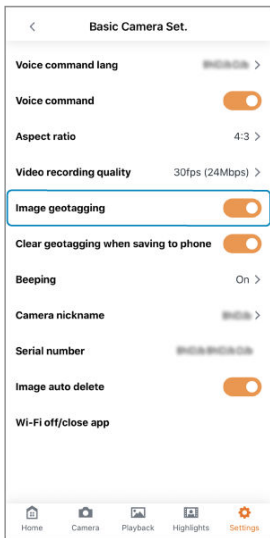

4. Tap [OK].

- From now on, images captured while the app is running will be geotagged.

⚠ Caution

- Images may not be geotagged if the camera cannot acquire location information from the smartphone when images are captured automatically, such as immediately after you turn on **[Image geotagging]**.
- Others may be able to locate or identify you by using location data in your geotagged still photos or movies. Be careful when sharing these geotagged images with others, as when posting them online where many people can view them.
- To remove the location information from images when they are saved to a smartphone, turn on **[Clear geotagging when saving to phone]**.

Creating Highlights (iOS Only)



Still photos and movies can be combined to create a short movie of highlights. This feature is available only in iOS.

Effective in these situations:

- Creating highlights of a bride and groom from images at the wedding ceremony and reception
- Creating highlights from vacation memories over several days

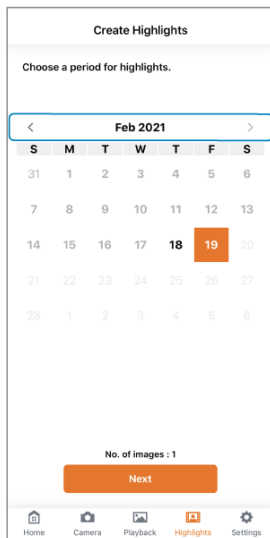
1. Tap  (Highlights) to access the highlights screen.
2. Select the month and year of shooting.



- Tap [ >] / [ <] to switch months and years.

3. Select the range of shooting days.

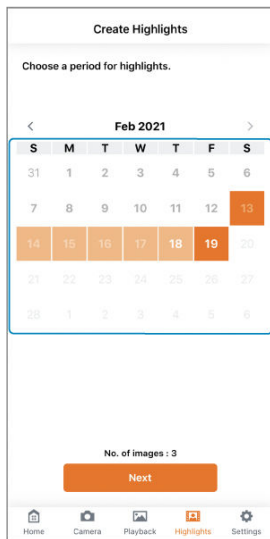

- Tap the starting date.
- Tap the ending date.
- To change the range, beginning with the starting date, tap again.
- Dates with captured images are shown in black.

4. Tap [Next].

5. Select registered people to prioritize.

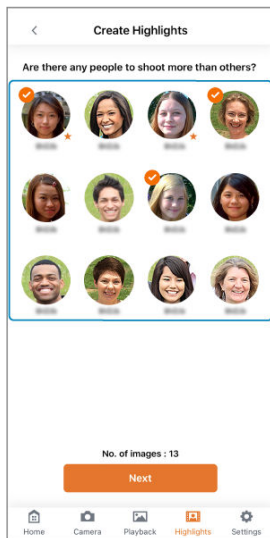

- Selected people are identified by a check mark.

6. Tap [Next].

7. Adjust settings as needed.

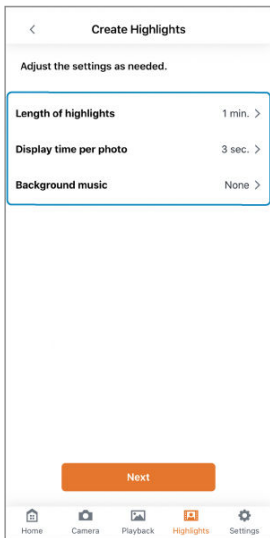

- Select [**Length of highlights**] to change the length of the highlight movie.
- Select [**Display time per photo**] to change the display time for still photo highlights.
- Select [**Background music**] to change the background music.

8. Tap [Next].

9. Tap [Create].



- A highlight movie is created from the images displayed.
- To use different images, tap **[Choose Manually]** and select images.

10. Tap [Save].

- The highlight movie created is saved to the smartphone.
- To view the created highlight movie, select **[Play]**.

Changing the Aspect Ratio

The aspect ratio for still photos can be changed.

1. Access the settings screen.
2. Tap **[Basic Camera Set.]**.

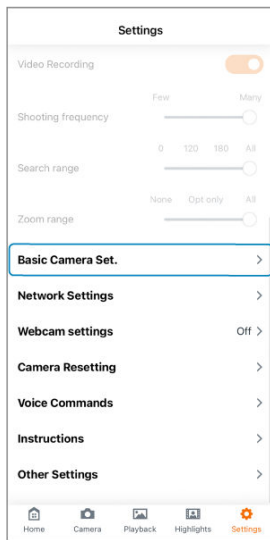

3. Tap [Aspect ratio].

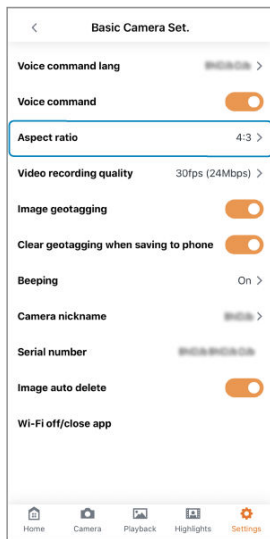

4. Select an option.

Changing the Video Recording Quality

The recording quality for movies can be changed.



Note

- Setting recording quality to a bit rate other than 12 Mbps will apply lower compression.
- Higher recording quality increases the file size, but motion in these movies is smoother.
- Movie recording may stop if the camera becomes hot. Consider using a lower recording quality if you prefer to record more or longer movies.
- Playback will not be smooth for high bit rate movies or where Wi-Fi is congested. In this case, try playback after you download the file.

1. Access the settings screen.

2. Tap [Basic Camera Set.].

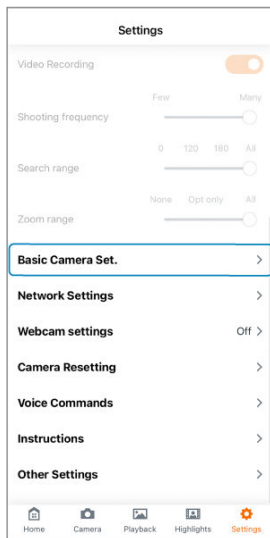

3. Tap [Video recording quality].

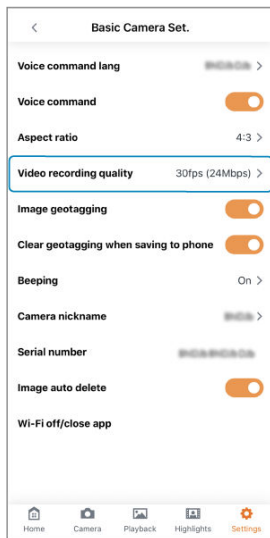

4. Select an option.

Changing Camera Sound Settings

Sounds of camera operations can be switched on or off.

1. Access the settings screen.
2. Tap **[Basic Camera Set.]**.

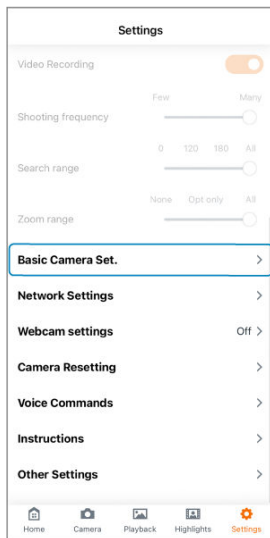

3. Tap [Beeping].

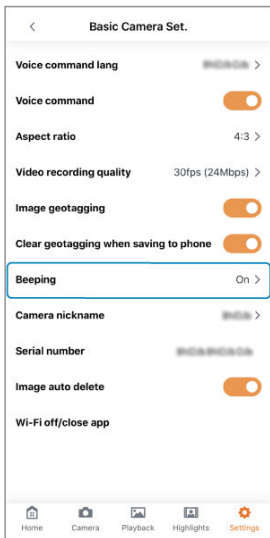

4. Adjust the setting as needed.

- Turning this option [**Off**] will prevent the camera from playing startup and error warning sounds.
- Selecting [**Mute auto shooting**] will prevent the camera from playing the automatic shooting sound.

⚠ Caution

- Shutter release sounds in response to voice commands are played even when [**Beeping**] is turned [**Off**].

Changing the Camera Nickname

The camera nickname at the top of the home screen can be changed.

1. Access the settings screen.
2. Tap **[Basic Camera Set.]**.

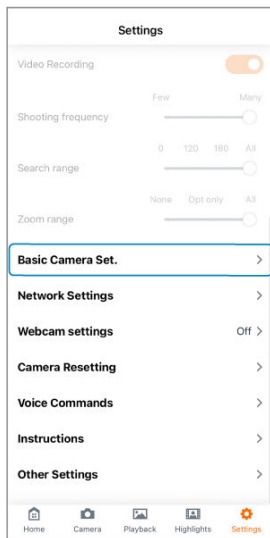

3. Tap [Camera nickname].

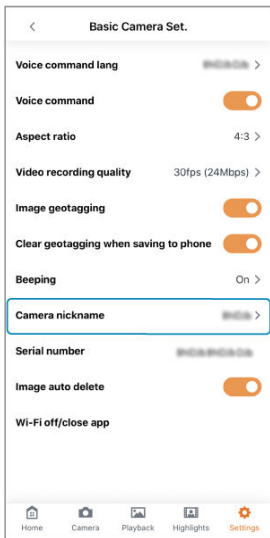

4. Enter text using the keyboard.

- You can enter upper or lowercase letters, numbers, or symbols. Enter up to 8 characters.

Changing Auto Image Deletion Settings

To avoid running out of free space on cards, captured images can be automatically deleted.

Caution

- If you turn on **[Image auto delete]**, be sure to tag as favorites any images you would like to keep or save them to a smartphone or computer before they are eventually deleted.

1. Access the settings screen.
2. Tap **[Basic Camera Set.]**.

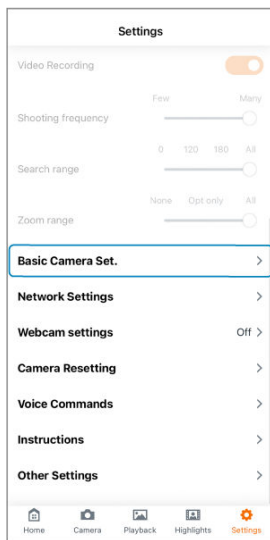

3. Turn on [Image auto delete].

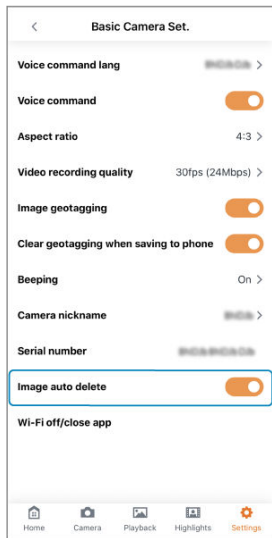

Caution

- Images are deleted to provide 2 GB of free space on cards of 8 GB or higher capacity when the free space drops below 1 GB.
- On cards with a capacity of less than 8 GB, images are deleted to clear 25% of the card as free space when the free space drops below 12%.
- Older images are deleted first.
- Images are tagged as favorites are not deleted.
- Images are not deleted when the camera is connected to a smartphone.
- **[Image auto delete]** is automatically turned off when a card becomes full of files excluded from auto deletion.
- Images are kept for at least one day before they may be deleted automatically.

Restoring Default Settings

You can reset camera and app settings or format cards in the camera.

If the card is new or was previously formatted (initialized) by another camera or computer, format the card with this camera.

Caution

- **Formatting a card deletes all images and data on it. Even protected images will be deleted, so make sure there is nothing you wish to keep. Save any data you need to a smartphone or computer before formatting the card.**

1. Access the settings screen.
2. Tap [Camera Resetting].

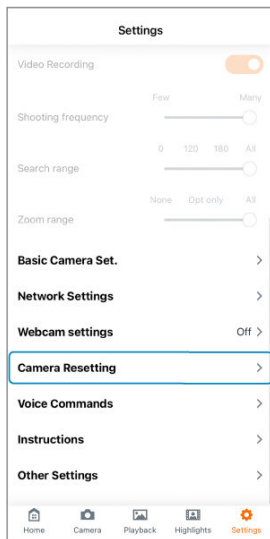

3. Select an option.



- **[Reset communication settings]**
Resets communication settings for the camera and app, and resets webcam settings.
- **[Reset all settings]**
Resets app settings, communication settings, and webcam settings. Information registered for people is also deleted.
- **[Format card]**
Formats the card in the camera.

 Caution

- After resetting communication settings, on the smartphone's Bluetooth settings screen, delete connection information for the camera with communication settings you reset.
- There is a need to perform [**Reset communication settings**] or [**Reset all settings**] when connecting other cameras and smartphones.
- You can also reset camera communication settings by turning the camera off and holding down the < (P) > button as you press the < (Power) > button.

Card file formats

microSD cards will be formatted in FAT12/16, microSDHC cards in FAT32, and microSDXC in exFAT.

Caution

- It may not be possible to use microSDXC cards formatted with this camera in other cameras. Also note that exFAT-formatted cards may not be recognized by some computer operating systems or card readers.
- Formatting or erasing data on a card does not completely erase the data. Be aware of this when selling or discarding the card. When disposing of cards, take steps to protect personal information if necessary, as by physically destroying cards.
- With a FAT32- or exFAT-formatted card, if you record a movie and the file size exceeds 4 GB, a new movie file will be created automatically.

Note

- The card capacity displayed on the card format screen may be smaller than the capacity indicated on the card.
- This device incorporates exFAT technology licensed from Microsoft.

Checking Network Settings

1. Access the settings screen.
2. Tap [Network Settings].

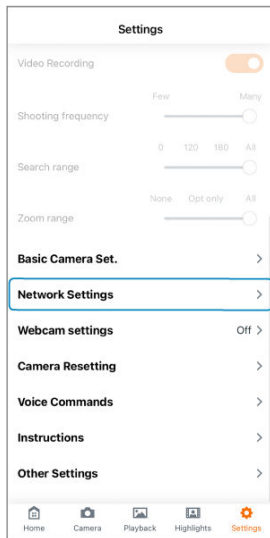

3. Select an option.

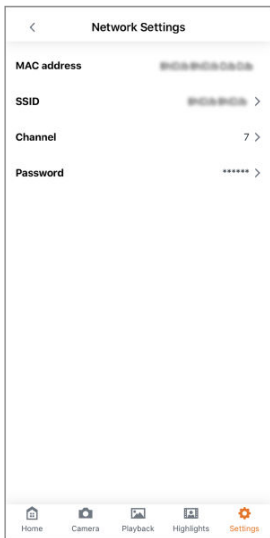

- **[MAC address]**
For checking the MAC address of connected cameras.
- **[SSID]**
For checking the SSID of connected cameras.
- **[Channel]**
For checking the Wi-Fi channel of connected cameras.
- **[Password]**
Enables you to change the Wi-Fi password for connected cameras.

Caution

- **[SSID]** and **[Password]** can only be checked when directly connected via Wi-Fi.

Using as a Webcam

 [Checking Access Point Settings](#)

 [Specifying Webcam Settings](#)

This section describes how to use the camera as a webcam by connecting the camera with a computer via a wireless LAN access point.

Checking Access Point Settings

The Wi-Fi base unit (such as a Wi-Fi router) to be used as an access point should be compliant with the Wi-Fi standards () shown in the specifications.

- **Network name (SSID/ ESSID)**

The available access points are SSID or ESSID. These are also referred to as the "Access Point Name" or "Network Name".

- **Network authentication/data encryption (encryption scheme/encryption mode)**

This scheme encrypts data during wireless communication. Check whether "WPA2-PSK (AES)", "WPA2-PSK (TKIP)", or "None" exist.

- **Passwords (encryption key/network key)**

These keys are used to encrypt data during wireless communication. These are also referred to as "encryption keys" or "network keys".



Caution

- When specifying settings in a network with a system administrator, ask the network administrator for network settings.
- This information is extremely critical for security. Take care when handling such information.



Note

- Routers are devices used to construct networks (LAN) by connecting multiple computers, etc. Also, routers with built-in Wi-Fi functions are known as "Wi-Fi routers".
- In this manual, all Wi-Fi base units such as Wi-Fi routers are referred to as "access points".
- If filtering MAC addresses with the access point you will join, add the camera's MAC address to the access point. You can check the camera's MAC address by referring to [MAC address] under [Network Settings] ()

1. Click the link below to install the Wireless Webcam Utility for Mini PTZ Cam software for connecting with computers.
<https://cam.start.canon/C009/>



2. Open the Settings screen on Connect App for Mini PTZ Cam.

3. Tap [Webcam settings].

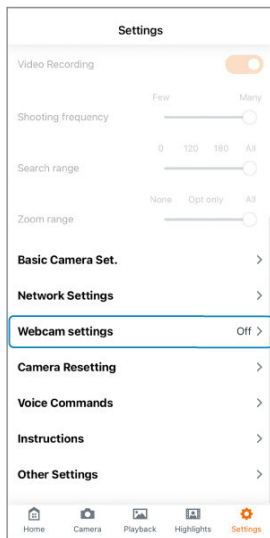

4. Set the wireless LAN access point.

< Webcam settings

Complete these settings to use the camera as a wireless webcam.
For details, visit the following website on your computer.
<https://cam.start.canon/C009/>

WLAN access pt.
Transmission frequency 2.4 GHz band

SSID < 33 char.

Password 8-63 char.

Security WPA2-PSK (AES/TKIP)

Register account
Use this account with the computer app.

User name < 33 char.

Password 8-32 char.

Set on cam.

Clear set.

Home Camera Playback Highlights Settings

- Enter the SSID and the password of the wireless LAN access point on the same network as the connected computer.
- For "Security", select the type used by the wireless LAN access point.

5. Register your webcam account.

< Webcam settings

Complete these settings to use the camera as a wireless webcam.
For details, visit the following website on your computer.
<https://cam.start.canon/C009/>

WLAN access pt.
Transmission frequency 2.4 GHz band

SSID < 33 char.

Password 8-63 char.

Security WPA2-PSK (AES/TKIP)

Register account
Use this account with the computer app.

User name < 33 char.

Password 8-32 char.

Set on cam.

Clear set.

Home Camera Playback Highlights Settings

- Register the desired username and password for the camera. Make a note of the username and password as they will be used for establishing connections with computers.

6. Press [Set on cam.].

- Register the wireless LAN access point and webcam account to the camera.
- If you forget the username or password for your webcam account, press [Clear set.] to delete all settings and perform step 4 again.

7. Press the <(P)> button on the camera once.

- If connecting the camera and Connect app for Mini PTZ Cam via SSID, press the <(P)> button twice.

8. Click the app icon in the notification area on the right side of the computer taskbar.



9. Select which camera to use as the webcam.

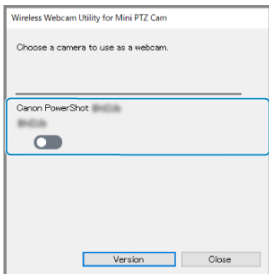

- Camera nicknames are shown.

10. Enter the username and password set in step 5 and press the **Connect** button.

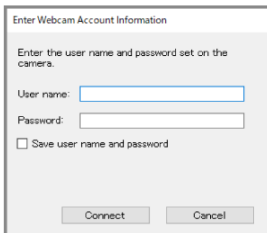

Enter Webcam Account Information

Enter the user name and password set on the camera.

User name:

Password:

Save user name and password

- The camera will be now available for use as a webcam.
- Specify this camera for use with web conferencing apps.

 **Note**

- To stop using the webcam and reconnect the camera to the Connect app for Mini PTZ Cam, restart the camera.
- To use the camera as a webcam again after the camera power has been turned off, turn on the camera again and perform the operation from step 7.

Checking Messages from the App

Two types of messages from the camera can be checked on the home screen: communication and error messages. In case of errors, check for messages.

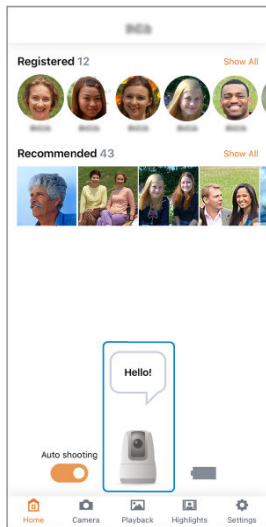

- **Example of a communication message**

"New photo to recommend!"

- **Example of an error message**

"Insert a card and restart the camera."

 **Note**

- You can review past messages by tapping the camera icon in the message display area. Tapping a speech bubble will display a screen used to respond to the message.

Responding to Error Messages

When an error occurs, display the details of the error by following one of the procedures below. Then, eliminate the cause of the error by referring to the examples shown in this chapter.

- View error messages on the home screen.
- Tap the camera icon in the message display area of the home screen.

Click the following error numbers to jump to the corresponding section.

W01	W02	W03	W04	W05	W06	W07
---------------------	---------------------	---------------------	---------------------	---------------------	---------------------	---------------------

W01: No access points found (error code: W01). For details, check the Advanced Guide online.

- Check whether the SSID entered for the wireless LAN access point during the webcam setting procedure (🔗) is correct.
- Check the access point settings (🔗)
- Check whether the access point is communicating using a channel and frequency supported by the camera (🔗). Also, when the access point channel is selected automatically, selecting one of the channels supported by the camera manually is recommended.
- Check whether the power of the access point has been turned on.

W02: Make sure that you entered the correct access point password (error code: W02). For details, check the Advanced Guide online.

- Check whether the password entered for the wireless LAN access point during the webcam setting procedure (🔗) is correct.
- Check the password settings for the access point (🔗).

W03: An error occurred in webcam mode (error code: W03). For details, check the Advanced Guide online.

- A connection could not be established with the access point.
- Check the access point settings (🔗)

W04: An error occurred in webcam mode (error code: W04). For details, check the Advanced Guide online.

- Check whether the security entered for the wireless LAN access point during the webcam setting procedure (🔗) is correct.
- Check the network authentication and data encryption settings for the access point (🔗).

W05: An error occurred in webcam mode (error code: W05). For details, check the Advanced Guide online.

What to check at the access point

- No address was assigned by the DHCP server.
- Check the DHCP settings for the access point.

What to check on the DHCP server

- **Is the power of the DHCP server on?**
 - Turn on the DHCP server.
- **Are there enough addresses for assignment by the DHCP server?**
 - Increase the number of addresses assigned by the DHCP server.
 - Remove devices assigned addresses by the DHCP server from the network to reduce the number of addresses in use.
- **Is the DHCP server working correctly?**
 - Check the DHCP server settings to make sure it is working correctly as a DHCP server.
 - If applicable, ask your network administrator to ensure the DHCP server is available.

W06: An error occurred in webcam mode (error code: W06). For details, check the Advanced Guide online.

- Wi-Fi conditions may be poor.
- Do not use near devices such as microwave ranges that have a frequency in the 2.4 GHz band.
- Bring this product near the device to which it will be connected (e.g., an access point or computer) without placing anything between the two.
- Check whether an error has occurred on the device to which this product is connected.

W07: An error occurred in webcam mode (error code: W07). For details, check the Advanced Guide online.

- Check the access point settings ()

1. Access the settings screen.
2. Tap [Other Settings].

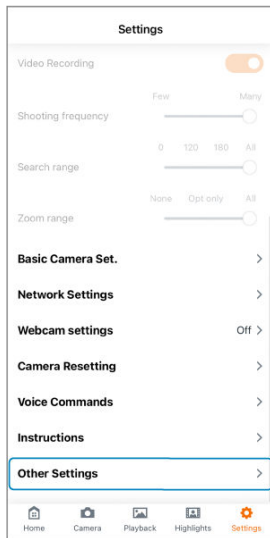

3. Select an option.

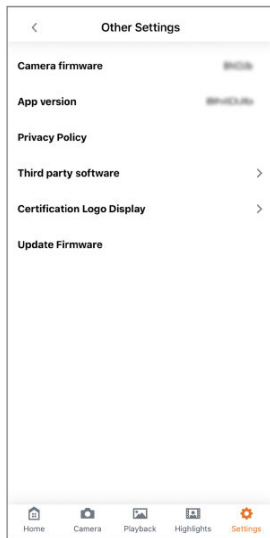

- **[Camera firmware]**
Shows the camera firmware version.
- **[App version]**
Shows the app version.
- **[Privacy Policy]**
Opens a webpage for the privacy policy.
- **[Third party software]**
Shows licensing information for open-source software and other technology used by the app.

- **[Certification Logo Display]**
Shows certification logo information.
- **[Update Firmware]**
For updating the camera firmware. Follow the instructions displayed.

Reference

This chapter provides reference information that may be useful when shooting.

- [Troubleshooting Guide](#)
- [Security](#)
- [Specifications](#)
- [Before Disposal](#)

Troubleshooting Guide

 [Power-related problems](#)

 [Shooting-related problems](#)

 [Problems with wireless features](#)

 [Playback problems](#)



If a problem occurs with the camera, first refer to this Troubleshooting Guide. If this Troubleshooting Guide does not resolve the problem, contact your dealer or nearest Canon Service Center.

Power-related problems

Cannot charge the camera.

- In case of charging issues, see [Charging the Camera](#). If the issue persists, follow the advice in [Camera operation is unstable, or buttons are unresponsive](#).



The camera is not activated even when turned on.

- Make sure the card is properly inserted ()
- Charge the camera ()

Battery life does not last long.

- Using the camera when it is fully charged is recommended ()
- If the camera cannot be used long even after full charging, it is time to replace the battery. Contact a Canon Service Center.

Camera operation is unstable, or buttons are unresponsive.

- An internal error may have occurred. Force the camera off by holding down the < > button on the camera body for about 8 sec. Wait a while before restarting the camera by pressing the < > button.

Shooting-related problems

No images can be shot or recorded.

- Make sure the card is properly inserted (🔗).
- If the card is full, switch to a card with free space, or delete unneeded images (🔗, 🔗).

The card cannot be used.

- If a card error message is displayed, see [Inserting/Removing Cards](#).

Movie recording stops by itself.

- If the card's writing speed is slow, movie recording may stop automatically. For cards that can record movies, see [Specifications](#). To find out the card's writing speed, refer to the card manufacturer's website, etc.
- Movie recording stops automatically at 29 min. and 59 sec.
- Movie recording in progress during auto shooting will end automatically when a voice command is detected.
- When the camera's internal temperature rises, automatic shooting stops and the camera may turn off. Leave the camera off and allow its internal temperature to cool down before attempting to turn it on again.

Video or audio disturbances occur during movie recording.

- If you lift the camera or record a moving subject during recording, sounds created by those movements may be recorded to the movie. Also, zooming as you record movies may cause exposure changes or lens sounds to be recorded, inaccurate lens aberration correction, or loss of focus.
- If the terminal cover comes in contact with the moving parts of the camera, any sound created by that contact may be recorded to the movie. For this reason, do not allow the terminal cover to come in contact with moving parts of the camera.

The image flickers or horizontal stripes appear during movie recording.

- Flickering, horizontal stripes (noise), or irregular exposures can be caused by fluorescent lighting, LED lighting, or other light sources during movie recording. Also, changes in the exposure (brightness) or color tone may be recorded.

The subject looks distorted during movie recording.

- If you move the lens to the left or right (panning) or shoot a moving subject during recording, the image may look distorted.

Captured images are blurry.

- Make sure the dome cover is free of smudges or dust and not fogged up. Clean the camera as described in Handling Precautions: Camera Care (🔗). For stubborn dirt, contact a Canon Service Center.

Cannot pair with a smartphone.

- Use a smartphone compliant with Bluetooth Specification Version 4.1 or later.
- Turn on Bluetooth from the smartphone settings screen.
- Pairing with the camera is not possible from the smartphone's Bluetooth settings screen. Start Connect App for Mini PTZ Cam installed on the smartphone to pair the devices.
- Only one smartphone can be connected to the camera. To connect a different smartphone, reset camera communication settings before pairing the other smartphone (🔗).
- When using Connect App for Mini PTZ Cam to reset communication settings, clear the Bluetooth settings information on the smartphone settings screen. After this, try pairing the devices again.
- Pairing is not possible with the camera connected to a computer via USB. Pair the devices with the interface cable disconnected from the computer.

Cannot reconnect from a smartphone.

- You can only connect to one camera at a time from your smartphone. To connect a paired smartphone with another camera, start Connect App for Mini PTZ Cam and clear the smartphone communication settings in accordance with the message that appears 60 seconds after the app has been started. Once cleared, attempt pairing again.
- Reconnecting is not possible if you have unintentionally reset the camera's communication settings, as by pressing a button by mistake. Start Connect App for Mini PTZ Cam and clear the smartphone communication settings in accordance with the message that appears 60 seconds after the app has been started. Once cleared, attempt pairing again.
- Make sure the smartphone OS is up to date. Updating to the latest version may be helpful.

The file numbering does not start from 0001.

- File numbering may not start from 0001 if there are already images on the card.

The shooting date and time recorded are incorrect.

- The smartphone's date and time are set on the camera when the devices are connected. Make sure the correct date and time are set on the smartphone.

Still photos and movies cannot be played back.

- Playback is not possible for images captured with another camera.

Sounds of camera operations are audible during movie playback.

- If you perform camera operations during movie recording, the camera's built-in microphone may also record sounds of lens operations.

Security

If security settings have not been properly set, the following problems may occur.

- **Transmission monitoring**
Third parties with malicious intent may monitor wireless LAN transmissions and attempt to acquire the data you are sending.
- **Unauthorized network access**
Third parties with malicious intent may gain unauthorized access to the network you are using to steal, modify, or destroy information. Additionally, you could fall victim to other types of unauthorized access such as impersonation (where someone assumes an identity to gain access to unauthorized information) or springboard attacks (where someone gains unauthorized access to your network as a springboard to cover their tracks when infiltrating other systems).

It is recommended to make use of the systems and functions to thoroughly secure your network, preventing these types of problems from occurring.

Specifications

Focal length

3.4 (W) - 10.2 (T) mm

35 mm equivalent focal length

19 (W) - 57 (T) mm equivalent

F-number (max. aperture)

f/2.8 (W) - 5.0 (T)

Shooting distance

20 cm to ∞ (W) / 30 cm to ∞ (T)

Pan/tilt movable range

	Pan/Tilt movable range
Pan direction	Max. approx. -170° (left) to $+170^{\circ}$ (right)
Tilt direction	Max. approx -20° (down) to $+90^{\circ}$ (up)
Roll direction	Fixed

Image Stabilizer

Available

Effective pixels

Max. approx. 11.7 megapixels

Total pixels

Approx. 12.8 megapixels

Effective sensor size

1/2.3-inch

Digital zoom

Still photos	Automatic shooting	Max. 4x
	Remote shooting	
Movies	Automatic shooting	
	Remote shooting	

Recording media

microSD, microSDHC, and microSDXC memory cards

* SD speed class-compatible.

* UHS-I supported.

Image type in still photo recording

JPEG

Still photo recorded pixels

	Recorded pixels (Pixels)
4:3 aspect ratio* ¹	12 megapixels (4000 x 3000)
16:9 aspect ratio	Approx. 9 megapixels (4000 x 2248)

* 1: Because distortion correction is applied, the relationship between recorded pixels and camera effective pixels is as follows:

(Camera effective pixels) < (Recording pixels)

Still photo file size / Number of possible shots

	File size [approx. MB]	Possible shots [approx. shots]
4:3 aspect ratio	5.0	11594
16:9 aspect ratio	4.4	13526

* The number of possible shots apply to a UHS-I compliant 64 GB card based on Canon testing standards.

* File size and number of possible shots vary depending on shooting conditions (including subject and ISO speed, etc.).

Movie format

Container format	MP4		
Aspect ratio	16:9		
Frame rate	59.94 fps	29.97 fps	23.98 fps
Recorded pixels	1920 x 1080 (Full HD)		

Estimated total recording time, video bit rate and file size for each movie recording size

Movie recording size			Total recording time for each card (approx. min.)		Movie bit rate (approx. Mbps)	File size (approx. MB/min.)
			32 GB	128 GB		
Full HD	59.94 fps	IPB (standard)	121.4	464.3	35	251.3
		IPB (standard)	175.7	650.1	24	172.6
	29.97 fps	IPB (Light)	344.1	1250.2	12	86.7
		IPB (standard)	175.7	650.1	24	172.6
	23.98 fps	IPB (standard)	175.7	650.1	24	172.6
		IPB (Light)	344.1	1250.2	12	86.7

Movie recording notes

* Video bit rate indicates video output only. Audio is not included.

* Movie recording is interrupted if the maximum recording time per movie (29 min. 59 sec.) is exceeded.

* When using Canon testing standard UHI-I compatible card.

Card performance requirements

Movie recording size			Memory card
Full HD	59.94 fps	IPB (standard)	SD Speed Class 6 or higher
		IPB (standard)	SD Speed Class 4 or higher
	29.97 fps	IPB (Light)	
		23.98 fps	IPB (standard)
	IPB (Light)		

Recording microphone

The camera features two built-in digital microphones (stereo).

* Not equipped with an external microphone terminal.

Metering brightness range

During still photo shooting	EV 1 to 18
During movie recording	EV 4 to 18

* At room temperature, ISO Auto

ISO speed

During still photo shooting

	ISO speed (auto range)
During auto shooting	ISO 100–6400
During remote shooting	ISO 100–6400

During movie recording

	Movie mode	ISO speed (auto range)
During auto shooting During remote shooting	Full HD (59.94 fps)	ISO 100–3200
	Full HD (29.97 fps)	ISO 100–3200
	Full HD (23.98 fps)	ISO 100–3200

Still photo shooting

Type

Electronic shutter, using the image sensor

Shutter speed

	Shutter speed (auto range)
During auto shooting	1/16000–1/8 sec. * User settings not possible
During remote shooting	

Movie recording

Type

Electronic shutter, using the image sensor

Shutter speed

	Shutter speed (auto range)
During auto shooting	1/16000–1/30 sec. * User settings not possible
During remote shooting	

Digital terminal

Terminal type

USB Type-C

Transmission

Equivalent to Hi-Speed USB (USB 2.0)

Battery

A rechargeable lithium-ion battery is built into the body.

Available operating time

Shooting mode	Automatic shooting frequency setting	Available operating time (approx.)
Automatic shooting	Low	5 hr. 00 min.
	Medium	3 hr. 30 min.
	High	2 hr. 00 min.

Dimensions and weight

Dimensions

Approx. $\Phi 56.4 \times 81.9$ mm (H)

Approx. $\Phi 2.22 \times 3.22$ in. (H)

* Same for black and white

* Based on CIPA guidelines.

Weight

Approx. 170 g

Approx. 6.00 oz.

* Same for black and white

* Including memory card

* Based on CIPA guidelines.

Approx. 169 g

Approx. 5.96 oz.

* Same for black and white

* Body only

Operating environment

Operating temperature

0°C–40°C / 32°F–104°F

Operating humidity

10%–90%

Bluetooth

Standards compliance

Bluetooth Specification Version 4.1 compliant (Bluetooth low energy technology)

Transmission method

GFSK modulation

Wi-Fi (wireless LAN)

Standards compliance

IEEE 802.11b/g/n

Transmission method

Supported Wi-Fi standard	Transmission method
IEEE 802.11b	DS-SS modulation
IEEE 802.11g	OFDM modulation
IEEE 802.11n	

Transmission frequency

2.4 GHz band

Channels

1 to 11

- All data above is based on Canon testing standards and CIPA (Camera & Imaging Products Association) testing standards and guidelines.
- Dimensions and weight listed above are based on CIPA guidelines.
- Product specifications and appearance are subject to change without notice.

Before Disposal

⚠ Caution

- DISPOSE OF USED BATTERIES ACCORDING TO LOCAL REGULATIONS.

📖 Note

- A screwdriver for M1.7 Phillips head screws is recommended for screw removal.

1. Turn the camera off.
2. Lift and remove the rubber feet on the bottom of the camera with a narrow tool such as a regular screwdriver.

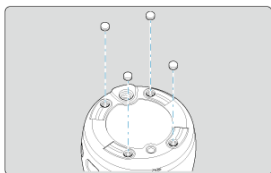

3. Remove the screws.

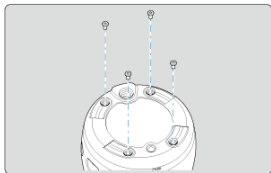

4. Remove the body cover.

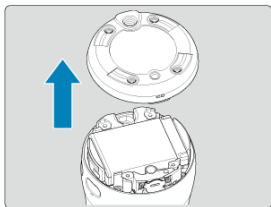

5. Remove the battery.

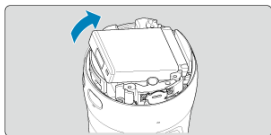

Trademarks and Licensing

[✔ Trademarks](#)

[✔ About MPEG-4 Licensing](#)

[✔ Accessories](#)

Trademarks

- App Store and macOS are trademarks of Apple Inc., registered in the U.S. and other countries.
- Google Play and Android are trademarks of Google LLC.
- IOS is a trademark or registered trademark of Cisco in the U.S. and other countries and is used under license.
- QR Code is a trademark of Denso Wave Inc.
- The Bluetooth® word mark and logos are registered trademarks owned by Bluetooth SIG, Inc. and any use of such marks by Canon Inc. is under license. Other trademarks and trade names are those of their respective owners.
- All other trademarks are the property of their respective owners.

About MPEG-4 Licensing

"This product is licensed under AT&T patents for the MPEG-4 standard and may be used for encoding MPEG-4 compliant video and/or decoding MPEG-4 compliant video that was encoded only (1) for a personal and non-commercial purpose or (2) by a video provider licensed under the AT&T patents to provide MPEG-4 compliant video. No license is granted or implied for any other use for MPEG-4 standard."

THIS PRODUCT IS LICENSED UNDER THE AVC PATENT PORTFOLIO LICENSE FOR THE PERSONAL USE OF A CONSUMER OR OTHER USES IN WHICH IT DOES NOT RECEIVE REMUNERATION TO (i) ENCODE VIDEO IN COMPLIANCE WITH THE AVC STANDARD ("AVC VIDEO") AND/OR (ii) DECODE AVC VIDEO THAT WAS ENCODED BY A CONSUMER ENGAGED IN A PERSONAL ACTIVITY AND/OR WAS OBTAINED FROM A VIDEO PROVIDER LICENSED TO PROVIDE AVC VIDEO. NO LICENSE IS GRANTED OR SHALL BE IMPLIED FOR ANY OTHER USE. ADDITIONAL INFORMATION MAY BE OBTAINED FROM MPEG LA, L.L.C. SEE [HTTP://WWW.MPEGLA.COM](http://www.mpegla.com)

* Notice displayed in English as required.

Use of genuine Canon accessories is recommended

This product is designed to achieve optimum performance when used with genuine Canon accessories. Therefore, using this product with genuine accessories is highly recommended. Canon shall not be liable for any damage to this product and/or accidents such as malfunction, fire, etc. caused by the failure of non-genuine Canon accessories. Please note that repairs arising out of the malfunction of non-genuine accessories will not be covered by the warranty for repairs, although you may request such repairs on a chargeable basis.