

User Manual

Introduction

Getting Started

Opening and Charging

Installing the Application

Connecting

Fishfinding

Sonar operational principles

Login

Main Screen

Smart Imaging : Detailed mode

Boat Mode

Onshore GPS Mode (Deeper Smart Sonar PRO+ only)

Ice Fishing Mode (Sonar + Flasher)

Menu

Calendar

Camera

Weather

Notes

Map

History

Settings

Compatibility

Drawings

Maintenance

Specification

Troubleshooting

Contact Us

Guarantee

Legal Information

Introduction

We thank you for purchasing Deeper and hope that you will enjoy using it as much as we have enjoyed creating it!

Please take your time to read this instruction manual which provides essential information on the usage of both the gadget and the application. We have also included various hints and tips that will help you get most out of your Deeper experience. Along the text you will find icons designed to draw your attention to different bits of information:



This icon marks useful hints about the usage of Deeper.



This icon marks safety precautions or information of similar importance.

[Back to TOP](#)

Getting Started

Before using the device, ensure you have read all the of safety information provided in the separate leaflet. This section provides you with quick step by step instructions from the moment you unpack your Deeper to your first fish finding. Follow the diagrams along with the comments to start using the gadget.



Deeper, UAB is continuously developing this product, therefore illustrations in this manual may not look the same as your product but your unit will function in the same way. Please refer to the electronic manual provided with each mobile application update.

[Back to TOP](#)

Opening and Charging

1. Ensure your Deeper gadget is dry before opening it.
2. Open the gadget by screwing it's top cover counterclockwise.
3. Connect the gadget with provided USB cable (or any other compatible charger).
4. Plug the charger to the mains (PC USB outlet or your car's power outlet).
5. Blinking frequency of the orange indicator represents the charging state. Higher number of blinks refers to higher charge level. Charging is complete whenever the indicator goes green. If the indicator glows red, your Deeper needs servicing. Please Refer to 'Guarantee' for further details.

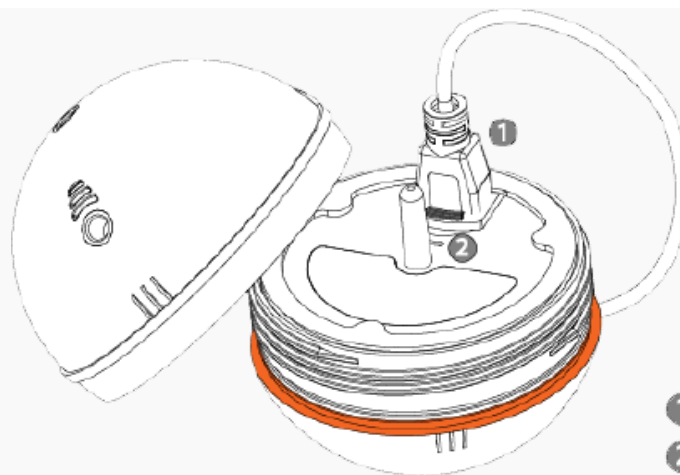

① USB Wire
② LED Indicator

The lithium-ion battery cannot be charged at a temperature below 3°C (37.4°F). If the indicator glows blue, it is too cold to charge the Deeper.

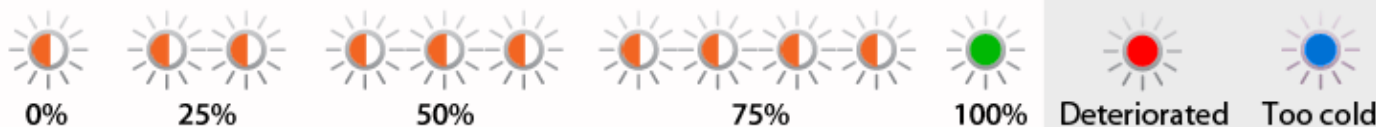

i Deeper is supplied with an uncharged battery. To ensure full capacity of the battery, charge it fully before using Deeper for the first time. Expected charging time is 2 hours. The lithium ion battery can be charged at any time without reducing its service life. Interrupting the charging procedures does not damage the battery. Disconnect the battery charger from the mains supply when not using it for long periods.

i When Deeper is fully charged the expected operational time is*:

Without GPS

Frequency 290 kHz – 6 hours

Frequency 90 kHz – 5 hours 30 minutes

With GPS

Frequency 290 kHz – 5 hours 30 minutes

Frequency 90 kHz – 4 hours 30 minutes

*Deeper was tested in 6 m (19,69 ft) depth, 20°C (68°F) temperature

x In order to increase the battery life of your Deeper, do not leave it uncharged for long periods of time. Even if you do not use your Deeper, recharge it every 6 months.

x Lithium Ion batteries like the one used in the Deeper can be dangerous if handled inappropriately. Make sure you follow the charging and battery safety rules provided in the separate leaflet.

x Do not charge Deeper while in the water. Protect dual USB car charger, the micro USB cable and the charging micro USB port against moisture.

[Back to TOP](#)

Installing the Application

1. *Go to Google Play or App Store online shops and search for the Deeper application.
2. Install the application just like any other by following onscreen instructions.



If you are not at the fishing spot yet but you can't wait to try out the features of your Deeper application, just launch it and press "Start". This will allow you to access most of the app's features, also providing a demonstration of how the application displays sonar information when your Deeper is being reeled in at a fishing spot ("Run simulation").



Refer to §4.11 for a list of compatible devices. [Compatibility](#).

[Back to TOP](#)

Connecting

1. Ensure your Deeper is either charging or immersed in the water and so is automatically powered on.
2. Keep in mind that connectivity process slightly differs for iOS and Android gadgets.
3. On Android you only have to launch the application and you're all set to use it. Deeper and your smartphone or tablet will connect automatically. In some cases, you may need manually connect your device, if you need to do that, please follow the instructions outlined in step number 5.
4. You will receive notifications if there will be two or more Deepers around you.
5. To connect Deeper to iOS device, you have to put Deeper in the water and head to smartphone or tablet settings. There you have to open WiFi settings and find access point which would look like this - Deeper-XXXX (symbols or digits). Once you do you will have to press Connect and enter a password: 12345678. Press join and go to Deeper app. Now you are able to start fish finding.

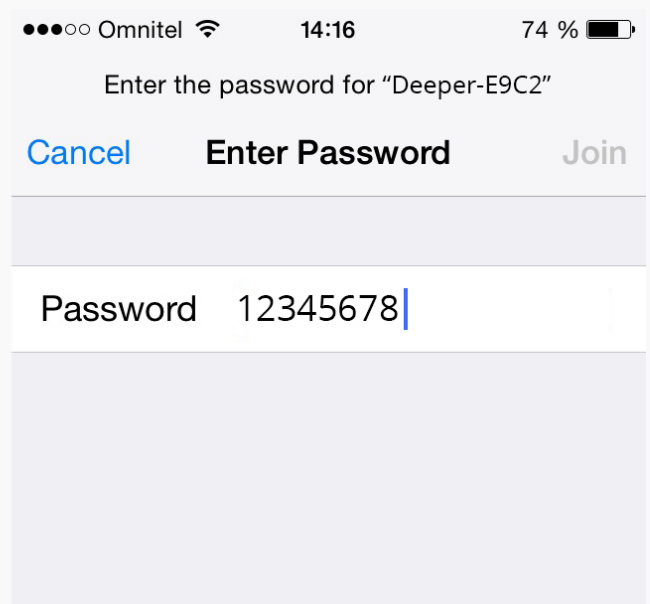

Every time while establishing the connection to Deeper, make sure the distance to the gadget does not exceed 10 meters / ~36 feet. Once you're connected, you can cast further.



If you are at your fishing spot, attach Deeper to a fishing line before immersing it into water as instructed in the following section - Fishfinding.

[Back to TOP](#)

Fishfinding

1. **Before you start fishing, make sure that the top cover is screwed on tight. To do so, put it on the Deeper case by aligning the waterproof marks, screwing counterclockwise till it dips in and then screwing clockwise. Close it tightly and keep in mind - the water marks should align perfectly as depicted in the picture.**

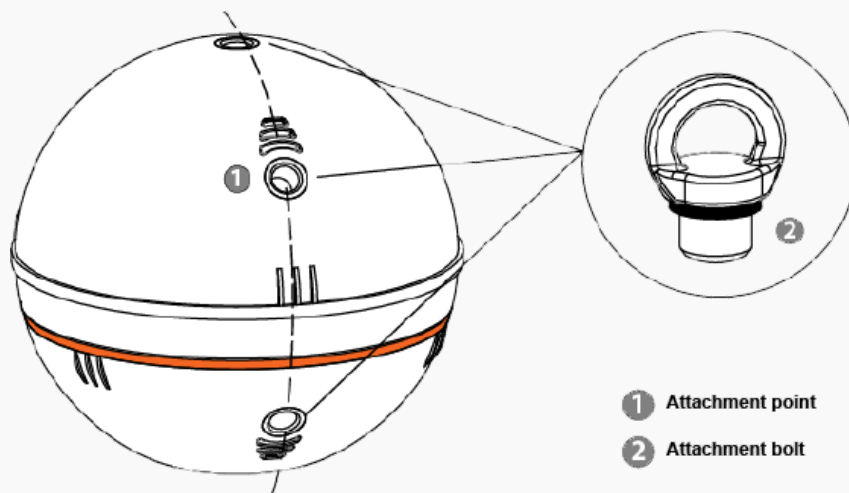

2. Screw an attachment bolt into a suitable attachment point. When you fish from the dock, screw it into the middle hole, and use the bottom one if you're fishing from the shore. When using the wrong bolts, Deeper bends in a diagonal position, therefore causing connectivity issues.
3. Securely attach the fishing line to the inserted attachment bolt.
4. Cast connected gadget to the desired spot.
5. Launch the application and start fish finding.
6. Either reel in your gadget for an overview or keep it stationary for fish monitoring.



Attach your gadget to a sufficiently strong fishing line and use a properly tightened knot. Also ensure that your fishing pole withstands the weight of Deeper. Otherwise you are at risk of losing the device, damaging the equipment, someone's property or even causing an injury.



When reeling the device, ensure it glides smoothly on top of the water with its heavy side facing towards the bottom as this will result in the most accurate sonar view.

[Back to TOP](#)

Sonar operational principles

Deeper can be operated at two different frequencies (Dual Beam). Precise narrow beam ($15^\circ@290\text{kHz}$) is used for high accuracy returns of fish, structure, detail and bottom profile. Wide beam ($55^\circ@90\text{kHz}$) provides ample search area for fish, bait fish and bottom structure.

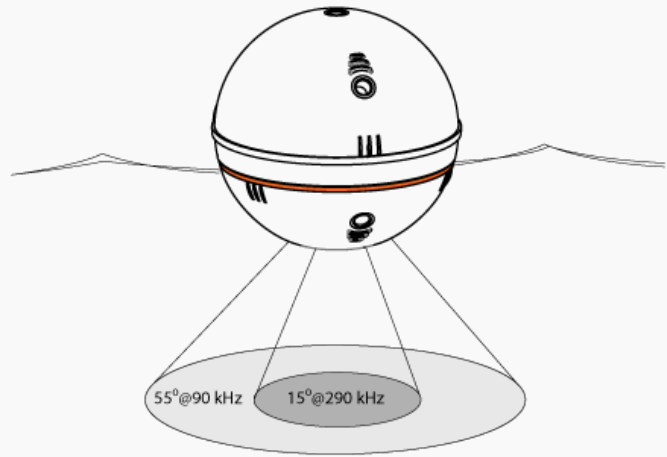

i It is best to use low frequency (90 kHz) setting to figure out, where the fish are and switch to the high frequency (290 kHz) setting to get more accurate information about fish position and bottom structure.

i By default, Deeper is set to high frequency (290 kHz) setting, which is designed for best performance and longest battery life.

[Back to TOP](#)

Login

Create an account:

Full name

Email

Password

Repeat password

Register

Or sign in with following accounts:

f

g+

[Terms and Conditions](#)

In order to start using Deeper application, you will be first forwarded to Deeper Login screen.

There you will have to register (for new user) or login (for an existing user). After you put all your credentials and you are registered or logged in the system, you will be able to start using Deeper app.



Some of the interface details might differ on smartphones and tablets.

[Back to TOP](#)



WiFi connectivity icon



Battery level of the Deeper gadget



Shows and hides the menu bar



Water temperature and depth at the current gadget position



Depth of a fish



Self-adjusting depth scale



Fish position and its relative size



Floor

Opens quick settings

Puts the gadget into a low power consumption sleep mode or wakes it up



Mutes/Unmutes sounds



Status of the device

The main screen displays interpreted sonar information. The top of the screen corresponds to physical water surface at the closest proximity of Deeper. The bottom of the screen corresponds to the water depth and bottom.

Deeper picks up only what is underneath it. The right side of the screen displays the most recent sonar scan information, the edge of it represents current information. Whenever new sonar information is received, the view is scrolled to the left.

The application stores history of the sonar data, which can be accessed by clicking on the history button. The history view can be manually scrolled, giving an overview of all the information which was acquired during the use of Sonar. Deeper now saves unlimited amount of information, so you can access your sonar reading anytime you want.

The application also has sound notifications. You receive them according to your personalized settings when Deeper spots fish or the depth changes. Sound notifications can be muted by the mute button. Green light indicator blinks upon reception of data packages.



Sound notifications can also serve as incoming fish alarms when the gadget is kept stationary. Furthermore, when navigating with a boat you can use the minimum depth alarm to avoid getting grounded. However, this should only be used as an additional precaution.

[Back to TOP](#)

Smart Imaging : Detailed mode

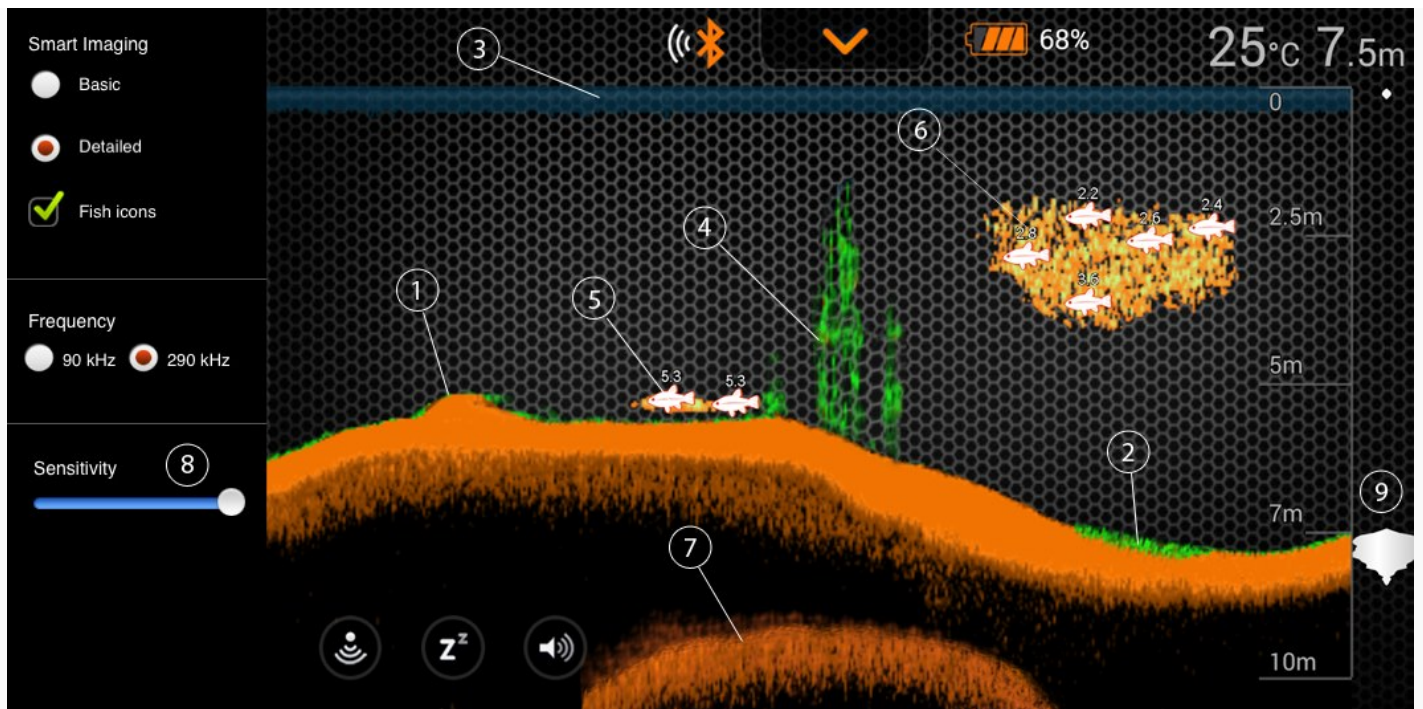

1. Deeper Smart Sonar can help you determine whether the bottom is hard or soft. When the sonar sound waves are reflected back by the bottom, hard bottom returns a stronger signal than a soft bottom. On your smartphone or tablet screen sonar returns are displayed as: orange (hardest), brown (medium) and black (smoothest).
2. The bottom of the water will always reflect the strongest signal, therefore it will have the most intensive color. The bottom is the continuous, intensely colored line running across the bottom of the screen.
3. High sonar sensitivity with our software algorithms allow us to determine weed beds, vegetation. These returns will be shown in green color.
4. Along the top of the screen, you will see a blue color water surface line with a grouping of intense colors. This area is surface clutter, which can be caused by waves or any other sonar interference at the surface of the water.
5. Deeper Smart Sonar includes the latest technology in interpreting bottom signals. It can scan through fish, structures and thermoclines. Large schools of fish or dense structures close to the bottom can affect water depth return readings.
6. The Fish icon option allows to find fish by viewing the actual sonar data or a combination of a fish symbol and actual sonar data. Simulated fish icons are displayed in three different sizes. The classification of fish depends on many variables, the weight of fish is just one of them, thus the icons cannot always identify accurate fish size. Therefore, if you prefer to see the actual size of fish, choose “Detailed Smart Imaging” and untick “Fish Icons”. In that case, you can see quite accurate fish size, however it is more difficult to identify them.
7. The unit will clearly show schools of Bait Fish as clouds of different shapes and sizes, depending on the number of fish and boat speed.
8. When the sonar sound waves are reflected back by the bottom, a hard bottom returns a stronger signal than a soft bottom. You may also see a second sonar return when the sonar signal bounces between the bottom and the surface of the water and back again. Hard bottoms will show a strong second return, while soft bottoms will show a very weak one or none at all.
9. Sensitivity controls how much detail is shown on the display of your smartphone or tablet and will adjust the sensitivity of all sonar frequencies. Increasing the sensitivity shows more sonar returns from small baitfish and suspended debris in the water. When operating in very clear water or greater depths, increased sensitivity shows weaker returns that may be of interest. Decreasing the sensitivity eliminates the clutter from the display that is sometimes present in muddy water. If Sensitivity is adjusted too low, the smartphone display may not show many sonar returns that could be fish.

[Back to TOP](#)

Boat Mode

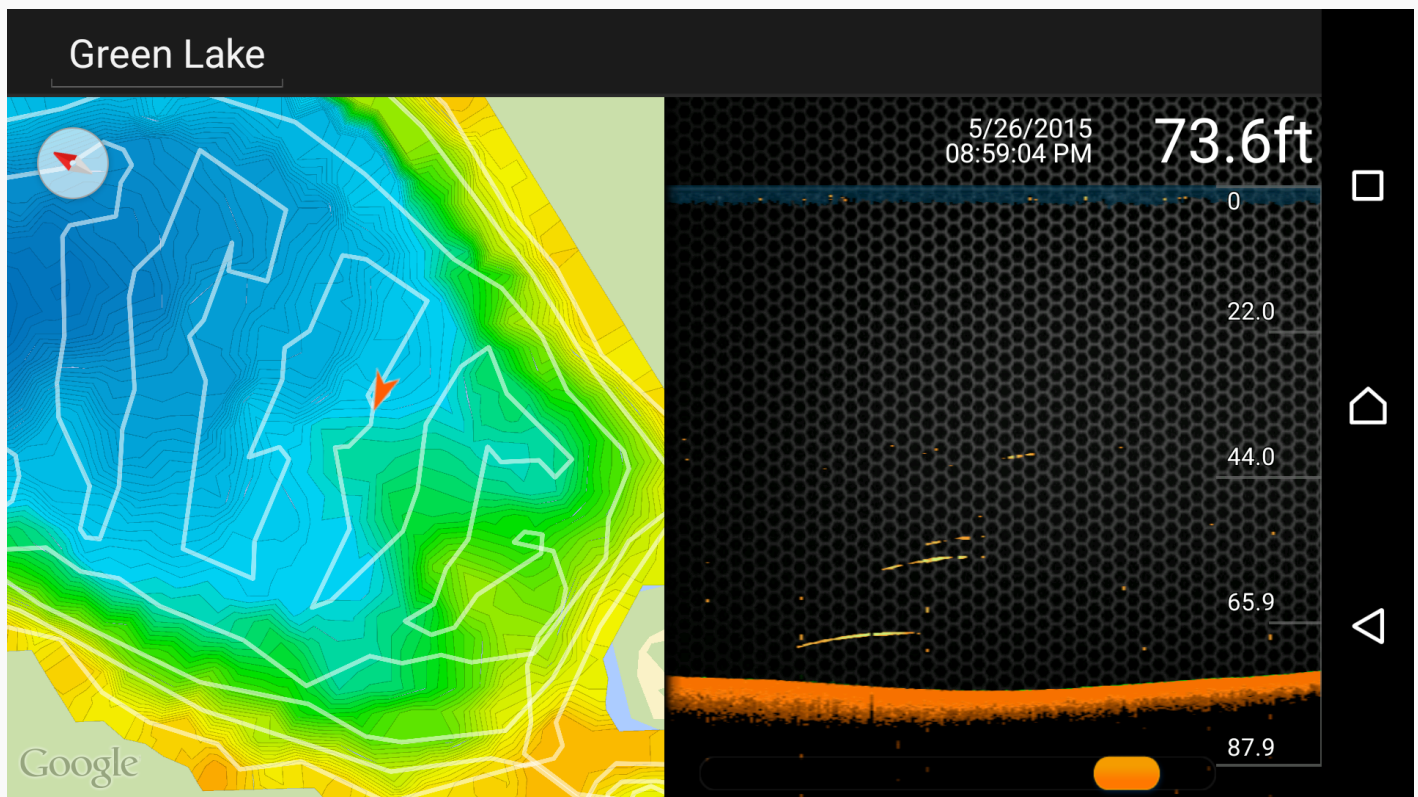

Deeper Smart Sonar enables you to create bathymetric maps of the favorite fishing spots. When operating in Boat Mode, Deeper instantly connects to GPS on your smartphone or tablet and creates custom, real-time bathymetric maps right on the screen. In order to sufficiently use Boat Mode, Deeper has to be in close proximity with your smartphone or tablet as GPS is integrated in the later ones, not in Deeper. These maps can be saved and accessed later through history function.

- 1. To use the feature, turn on the Boat Mode located in the upper menu bar in the main Settings field.*
- 2. The Mapping feature enables you to instantly monitor the bottom contour detail, depths, and locate the best fishing areas.*
- 3. The white lines indicates GPS record, while the colorful ones depict the isobath (depth curves). Therefore, it is easy to identify different depths according to the colors displayed on your device.*
- 4. In order to access unlimited data of the sonar imaging recordings and bathymetric map logs you can find it through History function located on the top menu bar.*
- 5. All of the sonar data is stored and conveniently presented in one place, so it doesn't take long to find what you need.*

[Back to TOP](#)

Onshore GPS Mode (Deeper Smart Sonar PRO+ o...

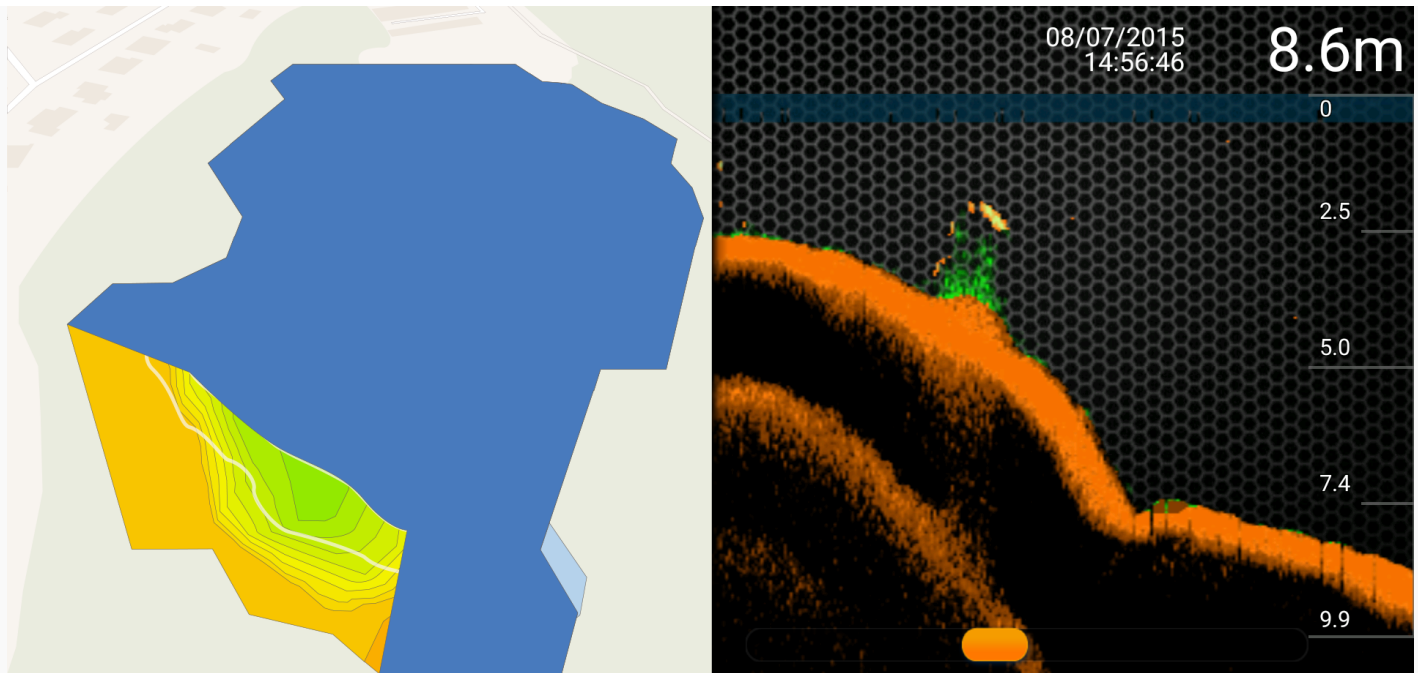

The Deeper Smart Sonar PRO+ contains a highly accurate internal GPS receiver that enables the device to map your favourite fishing spots by creating bathymetric, bottom contour maps even while fishing onshore. All bathymetric maps can be archived and accessed at any time to improve fishing location efficiency. This allows users to examine bottom conditions of the entire fishing location to determine the best opportunity for optimum fish bite. Onshore GPS Mode is operating in a same manner as the Boat Mode, but instead of using your smartphones' GPS (as it is done when operating Boat Mode) the Onshore GPS Mode uses the internal GPS receiver installed into the Deeper Smart Sonar PRO+ device. This enables you to create bathymetric, bottom contour maps even while fishing from the bank, dock or bridge.

 **GPS Status: Good fix.** GPS icon is green and constantly showing on the screen. Deeper Smart Sonar PRO+ location is known exactly. All GPS data is suitable for bottom contour mapping.

 **GPS Status: Acquiring position.** GPS icon is orange and blinking. Deeper Smart Sonar PRO+ is processing satellite information and currently your location is either not known (Deeper Smart Sonar isn't placed on the map) or not precise enough to be used for bathymetry (Deeper Smart Sonar is placed on the map). It is likely for GPS status to reverse from good fix back to acquiring position after recasting Deeper Smart Sonar PRO+ into water. When placing the device into water after longer standstill period (several days/weeks) it might result in a longer acquisition time.

 **GPS Status: Signal unavailable.** GPS icon is red. No GPS signal. The status might occur when Deeper Smart Sonar PRO+ is used indoors, inside a vehicle, under the boat roof, under the dense leafage or in other harsh natural conditions (e.g. gorge surrounding, rough water). Also if Deeper Smart Sonar PRO+ is being submerged.

Internal GPS receiver performance is depending on weather conditions, landscape features and satellites constellation.

[Back to TOP](#)

Ice Fishing (Sonar + Flasher)

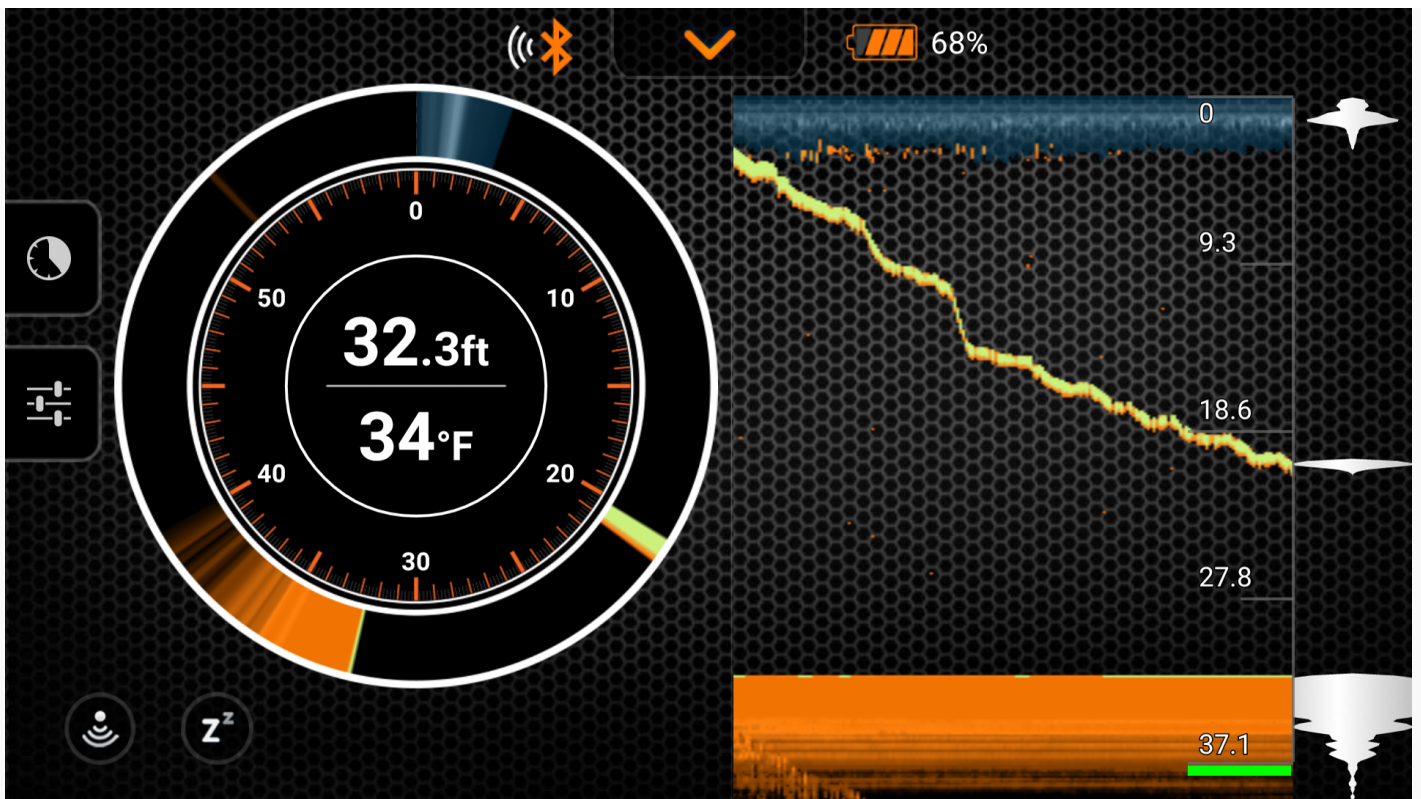

Deeper Ice Fishing feature enables traditional ice fishing Flasher Screen views to monitor conditions below the ice. The Amplitude Scope mode plots the depth and intensity of sonar return and displays live image of the activity below the transducer, enabling the unit to even track the movement of the smallest lure or bait.

- 1. To use the feature, turn on the Ice Fishing Mode located in the main Settings field.*
- 2. Additionally integrated Amplitude Scope mode plots the depth and intensity of a sonar return, displays a live image of the activity below the transducer, so you can track the movement.*
- 3. Split Screen mode allows you to see Regular and Flasher modes on one screen. So you can explore bottom contour, structure and see fish and your lure in real time at the same time.*
- 4. Zoom feature allows you to magnify the view of the area you choose on the Vertical Flasher for better real time tracking of your lure and prey. The zoomed view will be shown on the right side of the screen between the two red lines.*
- 5. Once the Ice-Flasher is on beam is automatically set to 290 kHz (15°) frequency that provides high-accuracy returns of lure, fish and bottom profile.*

[Back to TOP](#)

Menu

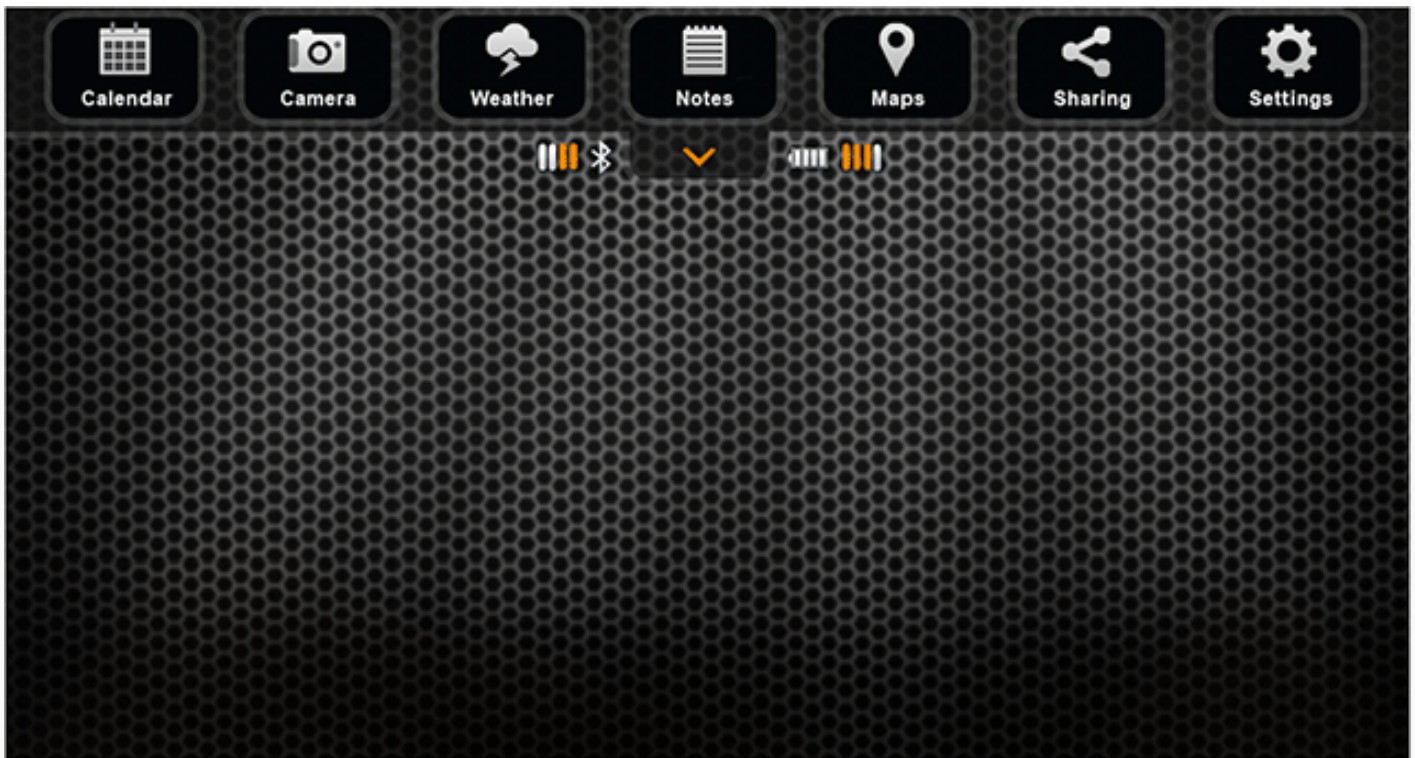

The menu of the main screen allows you to access various features of the application, as listed below:

- *Calendar displays moon cycles and fish activity levels at your chosen fishing location.*
- *Camera feature allows you to take photos of your catch without leaving the application.*
- *Weather displays current weather conditions and forecast for your chosen fishing location.*
- *Notes enables you to keep a fishing journal with pictures.*
- *Maps show your current location and help you find and manage fishing spots.*
- *History allows you to access your data and offline maps.*
- *Settings allow you to change setup of your application and gadget.*

[*Back to TOP*](#)

Calendar



The Calendar provides you with information about fish activity levels and lunar phases for a chosen fishing location. The fish activity level for each day of the month is presented by the orange circles. By clicking on a particular day in the Calendar you can see the hourly fish activity levels. The higher the fishing activity level is, the better is a chance of successful fishing.

On a GPS enabled mobile device Calendar will show information for your current position. You can check fish activity levels for a particular location by using search field or choosing it from your previously added fishing locations list. You can also add the location that you are currently viewing to this list.

Location added through the Calendar will also appear on the Map and will be classified as fishing location.



Location search



Locations list



Add location

[Back to TOP](#)

Camera



The Camera function allows you to take photos without leaving the application and save their entries along with comments. Just aim and click the shutter icon to snap a photo. The flash can be disabled or enabled by clicking its icon.

Once you take a photo, a screen will appear. On this screen you are be able to add a title, description and save the entry. You can also take additional photos by clicking on the camera icon or remove previous photos from this entry.

Saved photo entries will appear in the Notes along with the title, comments, date and weather conditions. The photo entry will also include the location at which it was taken if you are using a GPS enabled mobile device or a tablet.



Capture image



Disables/Enables flash



The photo entries can be shared on social networks through the Notes.

[Back to TOP](#)

Weather

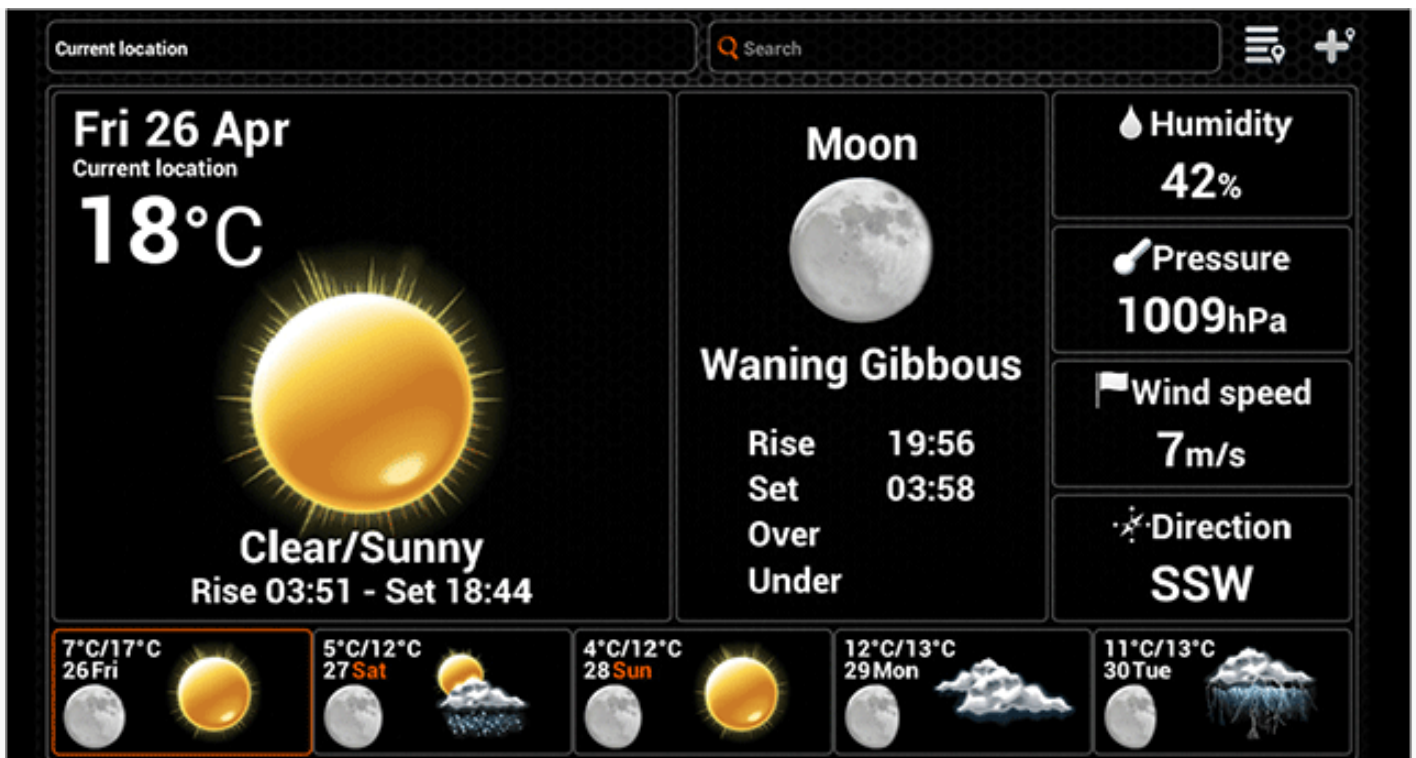

The Weather feature provides you with the current weather conditions and forecast for a certain location, along with other useful information such as rise and set times of the sun and the moon. On tablets, you can also access the detailed forecast for a certain day by clicking on it.

On a GPS enabled mobile device the Weather will open showing information for your current position. You can check the weather of a particular location by using the search field or choosing it from your previously added weather locations list. You can also add the location you are currently viewing to this list.

Locations added through the Calendar will also appear in the Map and will be classified as weather locations.



Location search



Locations list



Add location

[Back to TOP](#)

Notes

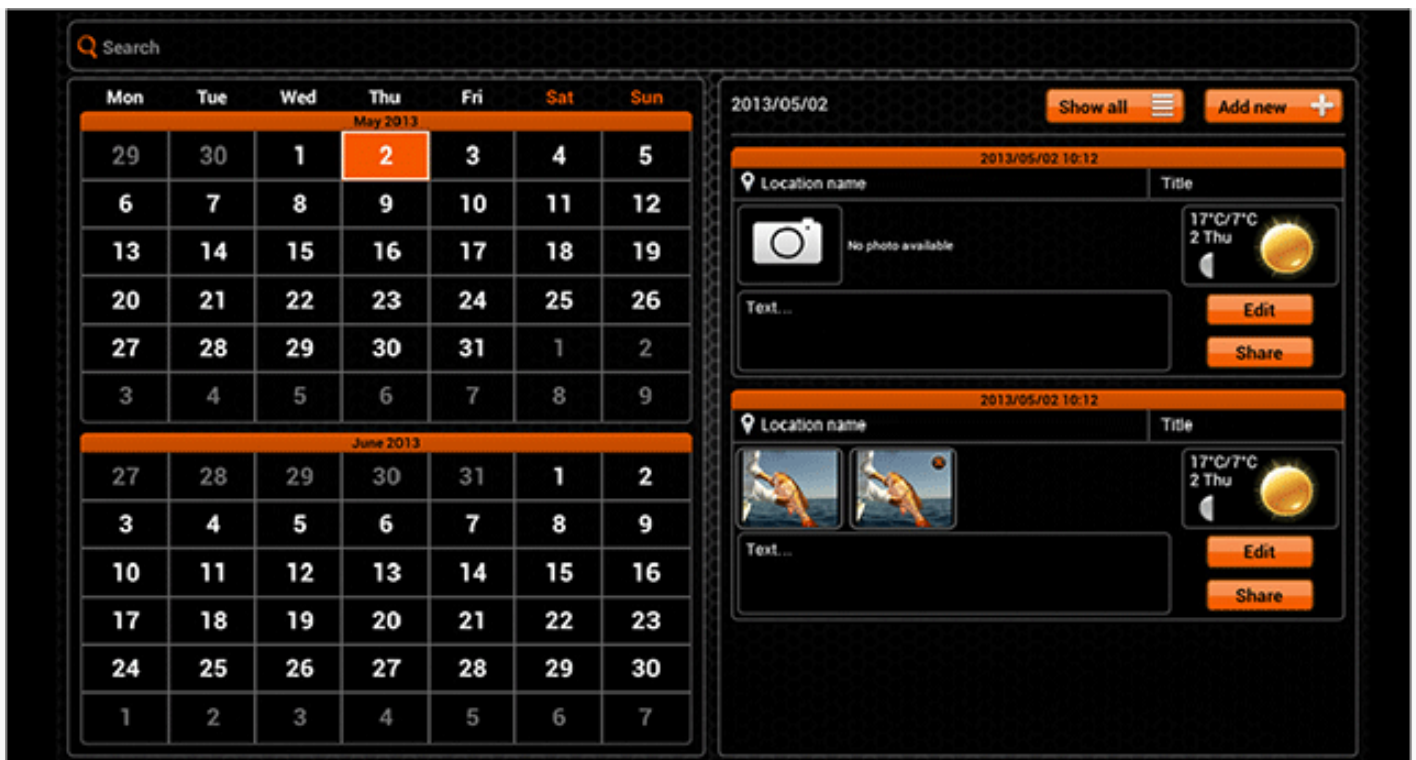

Notes allow you to keep a journal of fishing entries which is conveniently displayed on a calendar. Days containing note entries are displayed in orange. By clicking on a certain day, you can either view its existing entries or you can add new ones. Multiple log entries on the same date can be viewed by scrolling.

When forming a new entry, you can add a title and comments and take photos by clicking on the camera icon. The note entry also includes weather conditions during which the entry was made and location if you have a GPS enabled mobile device.

You can view the list of all of your Note entries, where you can edit an entry or share it on the social networks by clicking on the buttons next to it. An entry can be removed while editing it.



Notes list (tablet)



Add entry (tablet)



Add entry (smartphone)



Notes list (smartphone)

[Back to TOP](#)

Map

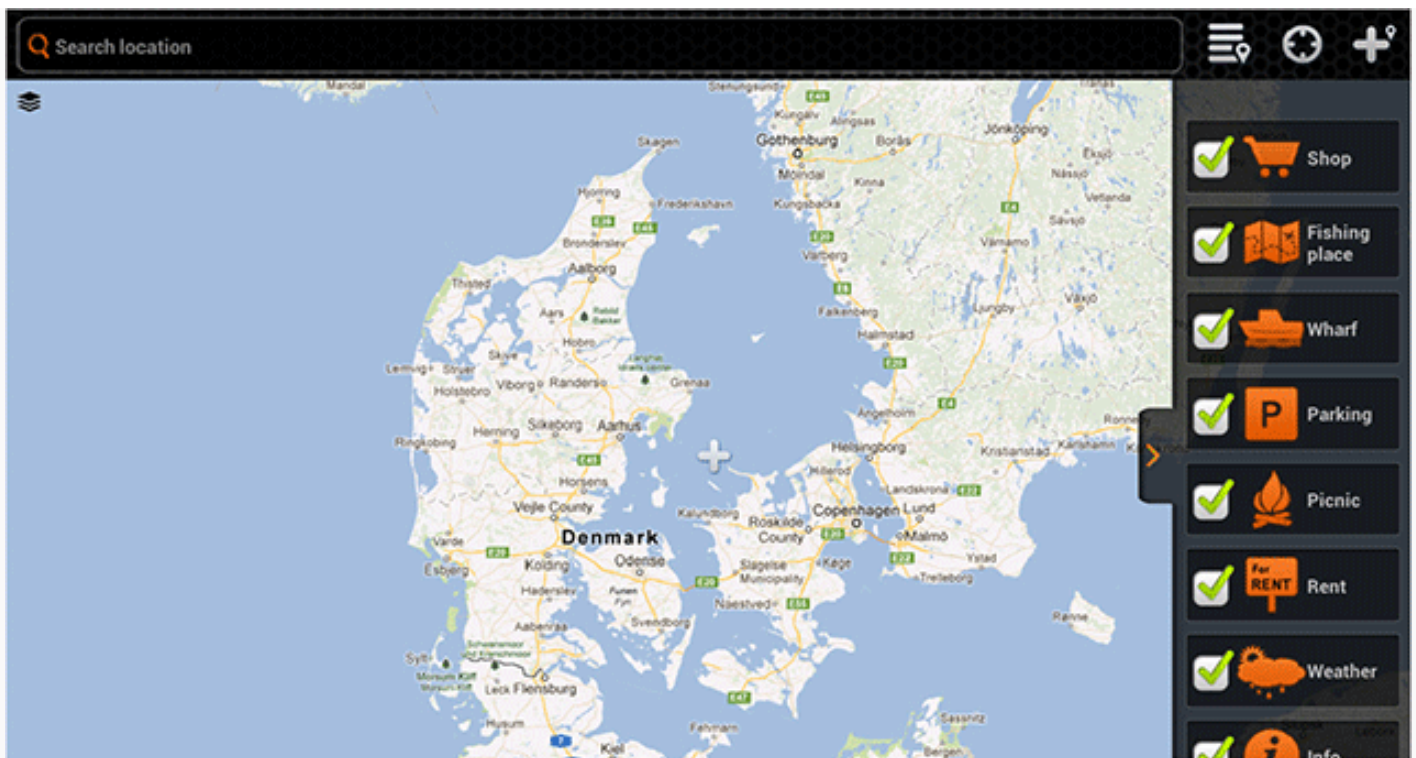

Google and the Google logo are registered trademarks of Google Inc., used with permission.

On a GPS enabled mobile device the Map will open showing your current location. You can explore it for various points of interest by panning, zooming in and out using the usual touchscreen gestures. If you get lost on the map, you can always center the map on your current location.

You can search for new locations by using the search field or you can choose from your previously added locations list. The locations are categorized by type which you can choose every time you add a new location. You can filter the types shown on the Map by clicking on the arrow at the right side of the map and unticking the ones you wish to hide.



Location search



Locations list



Current location



Add location

[Back to TOP](#)

History

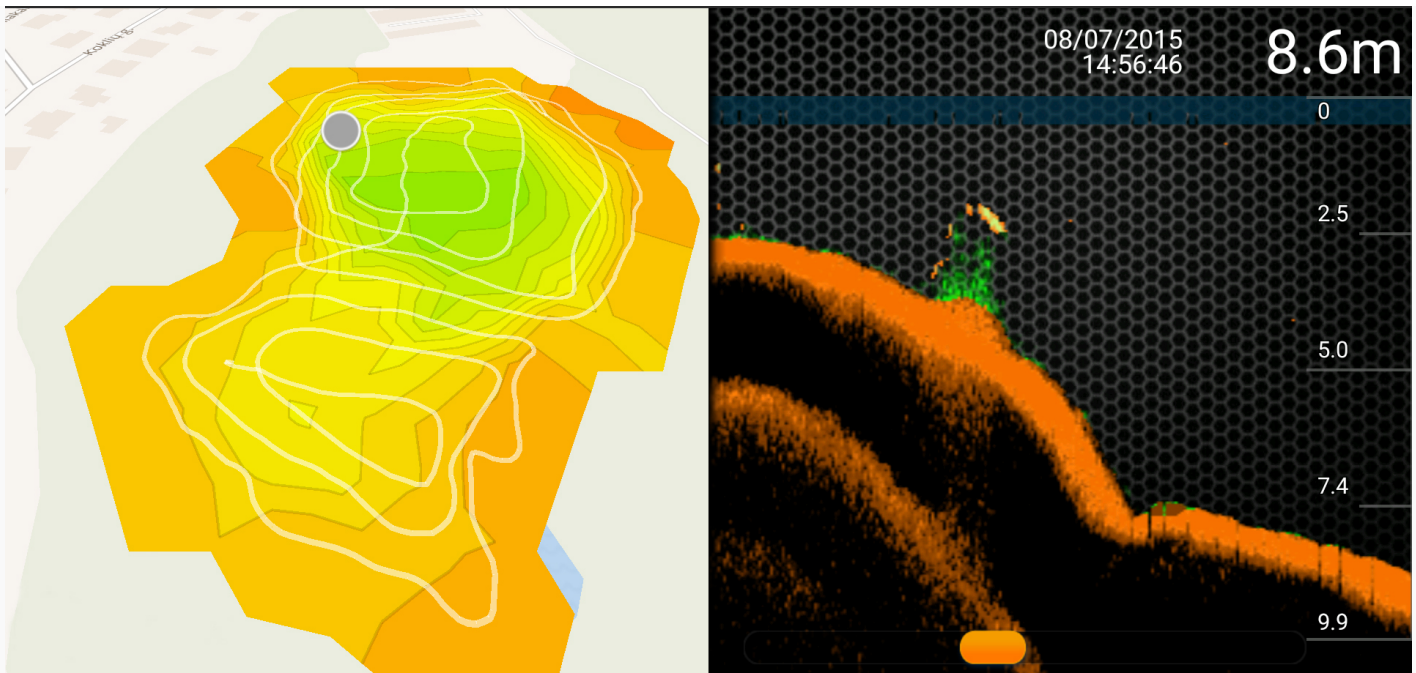

The History feature of the application allows you to access unlimited data history and offline maps.

You can scroll down through all recorded readings so as you can check your previously created bathymetric maps. Every recording can be scrolled from beginning to end. You are also able to see the exact date and time of the record, depth, fish icons and so on.

You can also rename every record by pressing on the Edit button on the right side of the screen and type your desired title or comment. In order to delete your records, you have to press the Select button, which is located on the top right hand side, choose the recording you want to move to trash and press Delete on the left bottom side.



Capture image

[Back to TOP](#)

Settings

The Settings allows you to configure the Deeper application according to your needs.



GENERAL

- *Select Language option lets you to manually select your apps language from all available choices.*
- *Units option allows you to change the units of the depth and temperature. You can choose from Metric (m, °C), Imperial (ft, °F) and Fathom (ftm, °F) units.*
- *Brightness changes the display brightness of your mobile or tablet device.*
- *Offline Maps feature is the way to downloading custom maps for an offline use. Maps are sorted depending on region and country. Once you download any map from the list, you will be able to access it anytime, even if you do not have internet connection.*
- *Accounts let you manage your personal account settings. You can logout from or login to your Facebook or Google+ accounts.*

- *Run Simulation button enables or disables demonstration mode, which displays sonar information at the main screen when a Deeper gadget is not connected to your smartphone or tablet.*



SONAR

- *Manage Deepers option allows you to manage connections to multiple Deeper gadgets if you have used more than one.*
- *Boat Mode turns on or turns off the Boating feature.*
- *Ice Fishing turns on or turns off Ice Fishing Mode.*
- *Frequency option allows you to choose between two operating frequencies, which results in different ultrasound viewing angles (wide or narrow angle beam).*
- *Vertical Flasher enables you to see sonar return intensity and should be switched on when you want to receive such information. You should turn it off when you do not wish to see it.*
- *Night Fishing feature should be turned on when fishing at night and using Deeper Night Fishing Covers. When you do not do this, it should be turned off.*
- *Depth Alarms enables and disables sound notifications, which are played when the water depth at the current gadget position falls below or exceeds the set values.*
- *Fish Alarm enables or disables sound notifications, which are played when the fish of a certain size is located at the gadget's position..*
- *Fish Depth enables or disables the depth indicators that are displayed over the fish icons.*



MANUAL

- *Read Manual option opens an electronic version of this manual.*
- *Version opens the information of the application version.*



BACKUP (Just For Android)

Allows you to backup the application data using cloud services. The backup includes note entries along with photos, added locations and settings.

- *Import the backup data.*
- *Export the backup data.*

[Back to TOP](#)

Compatibility

The Deeper gadget is confirmed to be compatible with particular iOS and Android devices:

iOS 8.0 and later

iPhone 4S, iPhone 5, iPhone 5C, iPhone 5S, iPhone 6, iPhone 6 Plus, iPhone 6S, iPhone 6S Plus, iPod Touch (5th generation), iPod Touch (6th generation), iPad 2, iPad (3rd generation), iPad (4th

generation), iPad Air, iPad Air 2, iPad Mini (1st generation), iPad Mini 2, iPad Mini 3, iPad Mini 4.

Android 4.0 Ice Cream Sandwich and later

The Android device must also have: Bluetooth, WiFi, built-in camera.

Screen density: mdpi, hdpi, xhdpi and xxhdpi

Screen sizes: Normal, Large and Xlarge.

We are working very hard to support as many devices and software versions as we can, but if you have a custom ROM for your Android device or a jailbroken iPhone you may experience issues that we have not accounted for in the public release. The list of compatible devices is being updated all the time, so if your device is not on the list do not panic! Most probably it will be on the list very soon. Also if you are having some issues, please let us know and we will try to sort it out.

[Back to TOP](#)

Drawings

1. Attachment points
2. Attachment bolt
3. Main seal
4. Antenna
5. Micro USB connection
6. LED status indicator
7. Sonar active face
8. Water sensor contacts

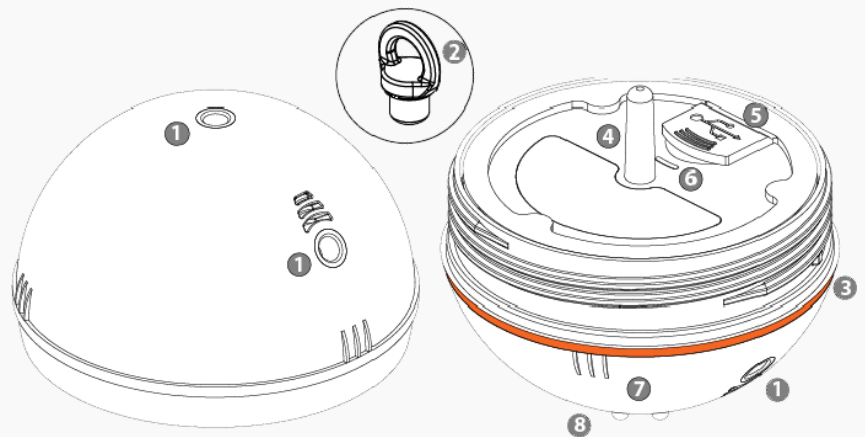

[Back to TOP](#)

Maintenance

The Deeper gadget has been designed in a way to minimize any required user maintenance. However, reasonable care procedures should be followed:

- Regularly check the condition of the orange main seal. If the seal is damaged, replace it immediately with a new one.
- Wipe off any remaining water from the gadget after each use.
- Regularly clean the gadget from dirt, dust, salt residue or any organic growth that may form over long usage. Avoid plastic solvents.
- When fishing under freezing conditions, clean any ice from the gadget and especially from its sonar active face as this may result in inaccurate sonar information
- Always keep your Deeper battery charged. Even if you do not use your Deeper, recharge it every 2 months.



Ensure you follow the safety rules provided in the separate leaflet.

[Back to TOP](#)

Specification

Unit size	Diameter 2.55 in (6.5 cm)
Weight	100 g (0.22 lb)
Connection	WiFi
Sonar type	Dual beam (wide and narrow)

Frequency	narrow - 290 kHz (15°) / wide - 90 kHz (55°)
WiFi range	Up to ~328 ft/ ~100 meters. Depends on OS and smartphone.
Depth range	Max. / Min. ~260 ft (80 m) / Wide angle - 4.3 ft (1.3 m); Narrow angle - 2 ft (0.5 m)
Construction	Water tight, ABS
Operational temp.	-20°C to 40 °C (4°F to 104 °F)
Battery	Lithium polymer 3.7 V rechargeable
Charging	Micro USB cable

[Back to TOP](#)

Troubleshooting Tips & Tricks

Start

Before you use Deeper, always make sure that you screw the top cover right. Water marks on the case and cover have to match perfectly, otherwise water leakage might damage your sonar. When you do it, you're all set to start!

Connection

To establish a connection place Deeper in the water no further than 16 feet (5 meters) away from you. If you're struggling or it takes too long, try to reload the application or reboot your smartphone.

Attaching Deeper

There are three attachment points on the Deeper. Never use the top one for angling, it is made for boat fishing. If you do, Deeper will bend diagonally, therefore causing connectivity issues. When you fish from shore, bank or dock, use the middle attachment bolt. Deeper will stay in a stable position ensuring smooth connectivity and best available connection range.

Hold your smartphone right

Keep in mind, that you shouldn't put your smartphone on the ground or keep it in your pocket either. It might cause connectivity issues. If you have a case for your smartphone or tablet, you can surely use it, though be aware that it has to be made from a light plastic. Metal cases or ones made of thick plastic will not transmit neither Bluetooth nor Wifi or radio signal. The best way to hold your smartphone is in your hands, though rod mounts are also very convenient.

Avoid the interference

It is very important to connect to Deeper with only one smart device at a time. If you have several smartphones or tablets, turn WiFi off on all the devices except the one you want to use. If your Deeper is not turning on in the water, it might be that the two metal contacts have been covered with dirt. Simply scrub them with a rough sponge or with a piece of cloth.

All these tips should help you get the most out of Deeper. But if you are still having some issues, please contact our customer support team and we'll be glad to help you!

[Back to TOP](#)

Contact Us

If you would like to get in touch with us, please use the Contact Us form provided in our website, www.buydeeper.com or email us directly at support@buydeeper.com. For any questions regarding the purchase of your Deeper, please contact your local distributor. The list of all Deeper distributors is also provided in our website, which is subject to change without prior notice.

[Back to TOP](#)

Guarantee

Guarantee

Dear Customer,

Thank you for purchasing Deeper, UAB product. We hope you will be happy using it. In the unlikely event that your product needs guarantee service, please contact your local dealer or an authorized service/support network member (ASN) or directly Deeper, UAB at support@buydeeper.com. To avoid any unnecessary inconvenience on your part, we recommend that you read the documentation carefully before seeking guarantee service.

Your guarantee

This guarantee applies to your Deeper, UAB product if stated in the leaflets that accompanied your product provided that it was purchased within the Guarantee area. Deeper, UAB guarantees the product to be free from defects in material and workmanship at the date of original purchase for a periods of not less than one year from that date. The Deeper, UAB company that provide and will honor this guarantee is designated in this guarantee or accompanying leaflets under the country where you seek guarantee service. If within the guarantee period the product is determined to be defective (at the date of original purchase) due to improper materials or workmanship, Deeper, UAB or an ASN member in the Guarantee area will, without charge for labour or parts, repair or (at Deeper, UAB discretion) replace the product or it's defective parts subject to the terms and limitations below. Deeper, UAB or ASN members or dealers may replace defective products or parts with new or refurbished products or parts. All products and parts replaced become the property of Deeper, UAB .

Terms

1. Guarantee services will be provided only if the original invoice or sales receipt (indicating the date of purchase, model name and dealer's name) is presented with the defective product within the guarantee period. Deeper, UAB or dealers or authorized service network (ASN) may refuse free of charge guarantee service if these documents are not presented or if they are incomplete or illegible. This guarantee will not apply if the model name or serial number on the product has been altered, deleted, removed or made illegible.
2. This Guarantee does not cover transport costs and risk associated with transport of your product to and from Deeper, UAB or a dealer or an ASN member.
3. This guarantee does not cover:
 - a) periodic maintenance and repair or parts replacement due to wear and tear.
 - b) consumables (components that are expected to require periodic replacement during the

lifetime of a product such as batteries).

c) damage or defects caused by use, operation or treatment of the product inconsistent with normal personal use described in this manual.

d) damage or changes to the product as a result of misuse, including:

- neglect*
- accidents, excessive heat, fire, chemicals, dust, other substances, vibrations, power surges, excess or incorrect supply or input voltage, radiation, electrostatic discharges including lighting, other external forces and impacts.*
- treatment resulting in physical, cosmetic or surface damage or changes to the product.*
- failure to use the product for its normal purpose or in accordance with Deeper user manual on use.*
- failure to follow Deeper User Manual instructions.*
- failure to follow Deeper safety usage and regulations instructions*
- use of the product in a manner inconsistent with the technical or safety laws or standards in the country where it is used*
- use of the product with accessories, peripheral equipment and other products of a type, condition and standard other than prescribed by Deeper, UAB*
- repair or attempted repair by persons who are not Deeper, UAB or ASN members*
- adjustments or adaptations without Deeper, UAB prior written consent, including:*
 - a) upgrading the product beyond specifications or features described in the instructional manual, or*
 - b) modification to the product to conform it to national or local technical or safety standards in countries other than those for which the product was specifically designed and manufactured.*
- battery of the gadget if the charging cycles of it has exceeded 300, as tracked by the firmware. Please note that in this case the battery can still be replaced at your own expense by the Out Of Warranty service provided by Deeper, UAB*

4. This guarantee covers only hardware components of the product. It does not cover software (whether of Deeper, UAB or others) for which an end user license agreement or separate warranty/guarantee statements or exclusions are provided or intended to apply.

5. Deeper, UAB does not warrant that the operation of the Deeper will be free of errors or interrupts. Small glitches may occur due to the reasons described in the troubleshooting chapter of this manual or due to the other unforeseen circumstances out of our control, such as changes in software or its configuration of the mobile or tablet device being used with the gadget.

6. We would like to inform you that the diagnostic fee of your product shall be paid by you if:

a) the diagnosis of your product performed by Deeper, UAB or by an authorized dealer or by an authorized Service center proves that you will not be entitled to a repair under this guarantee (for whatever reason) to rectify the defect;

b) or your product is working properly and no hardware fault could be diagnosed.

How to obtain warranty support?

Before submitting a warranty claim, we recommend to contact us at support@buydeeper.com for technical assistance. Valid warranty claims are generally processed through the point of purchase during the first thirty (30) days after purchase; however, this period of time may vary depending on where you purchased your product please check with Deeper, UAB or the retailer where you purchased your product for details. Warranty claims that cannot be processed through the point of purchase and any other product related questions should be addressed directly to Deeper, UAB . The addresses or customer service contact information for Deeper, UAB can be found in the

documentation accompanying your product or on the web at www.buydeeper.com.

Exclusions and limitations

Except as stated above, Deeper, UAB makes no warranties (express, implied, statutory or otherwise) regarding product or accompanying or constituent software quality, performance, accuracy, reliability, fitness for a particular purpose, or otherwise. If this exclusion is not permitted or fully permitted by applicable law. Deeper, UAB excludes or limits its warranties only to the maximum extent permitted by applicable law. Any warranty that cannot be fully excluded will be limited (as far as permitted by applicable law) to the duration of this guarantee. Deeper, UAB only obligation under this guarantee is to repair or replace products subject to these guarantee terms and conditions.

a) impaired or non operation of the product or associated products through defects or unavailability while with Deeper, UAB or an ASN member, which caused downtime, loss of user time or business interruption

b) inaccuracy of output from the product or associated products

c) other causes..

This applies to loss and damages under any legal theory, including negligence and other torts, breach of contract, express or implied warranty, and strict liability (even where Deeper, UAB or an ASN member has been advised of the possibility of such damages).

Where applicable law prohibits or limits these liability exclusions, Deeper, UAB excludes or limits its liability only to the maximum extent permitted by applicable law. Deeper, UAB liability under this guarantee will in no case exceed the price paid for the product, but if applicable law permits only higher liability limitations, the higher limitations apply.

Your legal rights reserved

Consumers have legal (statutory) rights under applicable national laws relating to the sale of consumer products. This guarantee does not affect statutory rights you may have nor those rights that cannot be excluded or limited, nor rights against the person from whom you purchased the product. You may assert any rights you have at your sole discretion.

No other warranties

No Deeper, UAB dealer, agent, or employee is authorized to make any modification, extension, or addition to this warranty.

Transportation

The contained lithium ion batteries are subject to the Dangerous Goods Legislation requirements. The user can transport the product by road without further requirements. When being transported by third parties (e.g.: air transport for forwarding agency), special requirements on packaging and labeling must be observed. For preparation of the item being shipped, consulting an expert for hazardous material is required.

[Back to TOP](#)

Legal Information

© 2016 Deeper, UAB . Patents pending. All rights reserved. 'Deeper' is a trademark of Deeper, UAB

. The trademark may not be used without the permission of Deeper, UAB . Reproduction in whole or in parts is prohibited without prior consent from Deeper, UAB .

Deeper, UAB reserves the right to change any information provided in this document without prior notice.

The WiFi wordmark and logos are owned by the Wi-Fi Alliance and any use of such marks by Deeper, UAB is under license from Wi-Fi Alliance.

Apple, iPhone, iPad and iPod are registered trademarks of Apple Inc., registered in the U.S. and other countries. App Store is a service mark of Apple Inc.

“Made for iPhone,” and “Made for iPad” mean that an electronic accessory has been designed to connect specifically to iPhone, or iPad, respectively, and has been certified by the developer to meet Apple performance standards. Apple is not responsible for the operation of this device or its compliance with safety and regulatory standards. Please note that the use of this accessory with iPhone, or iPad may affect wireless performance.

iOS is a trademark or registered trademark of Cisco in the U.S. and other countries and is used under license.

Android, Google Play, Google Maps, Google logo and Google+ are registered trademarks of Google Inc., registered in the U.S. and other countries.

Other trademarks and trade names mentioned in this document or in the separate leaflet provided are for identification and instructional use only and may be trademarks or registered trademarks of their respective owners.

[*Back to TOP*](#)