

296.00 mm

210.00 mm

PHILIPS

Micro Music System

4000 Series

M4205

Quick Start Guide



Register your product and get support at www.philips.com/support

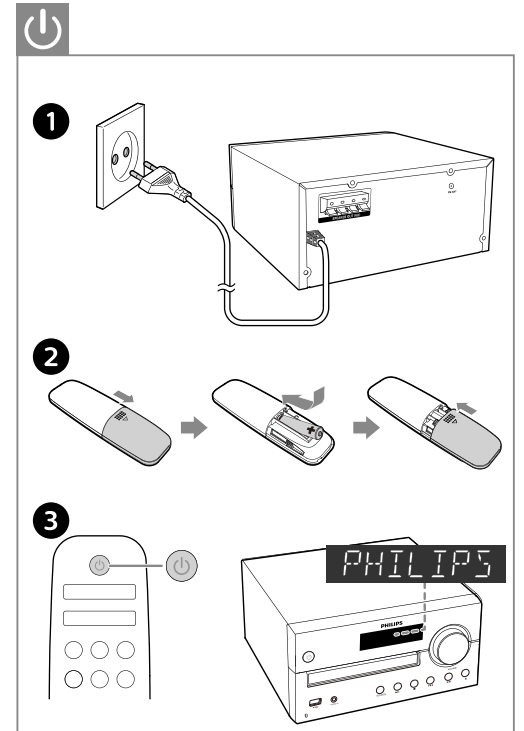
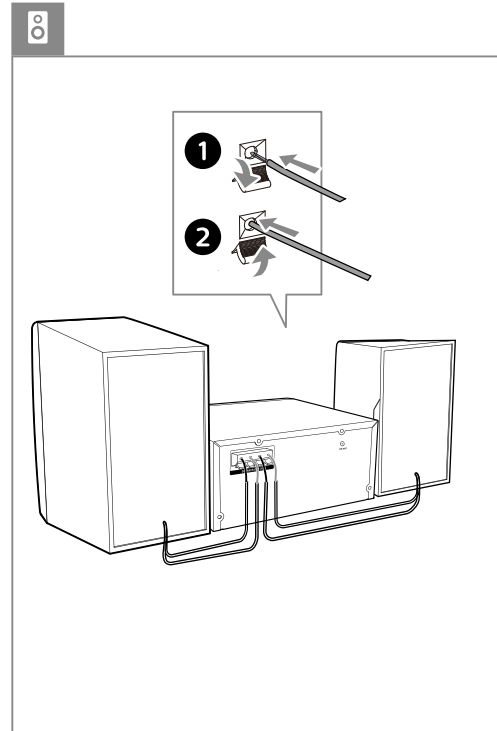
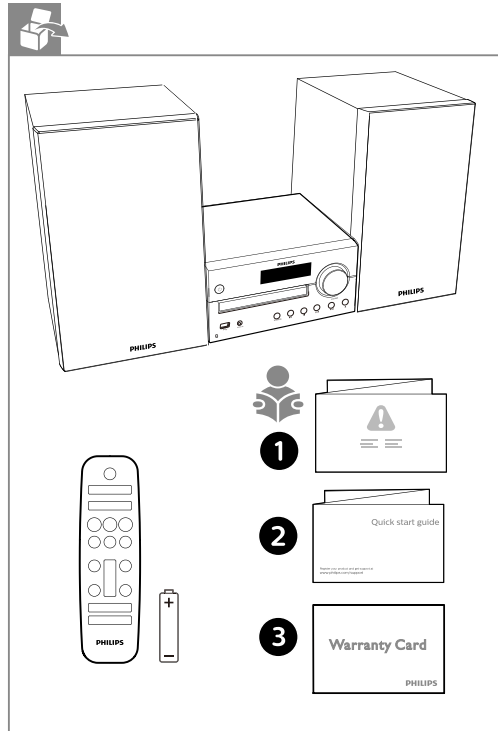

www.philips.com/support



Philips and the Philips Shield Emblem are registered trademarks of Koninklijke Philips N.V. and are used under license. This product has been manufactured by and is sold under the responsibility of MMD Hong Kong Holding Limited or one of its affiliates, and MMD Hong Kong Holding Limited is the warrantor in relation to this product. M4205_12_QSG_V1.0

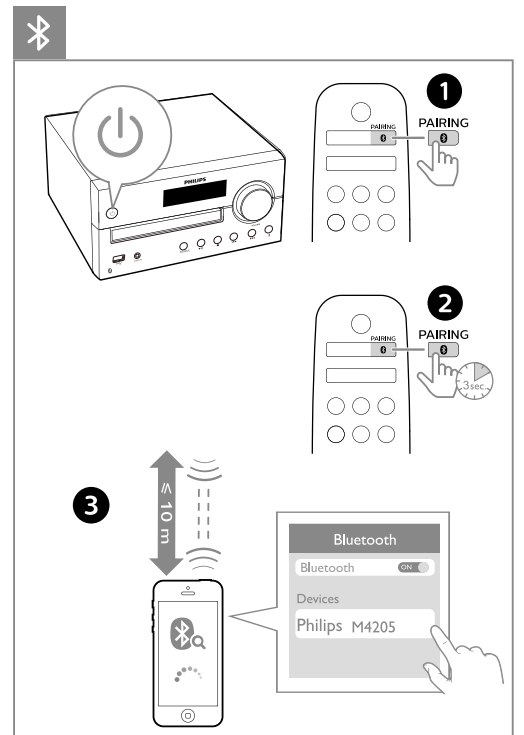
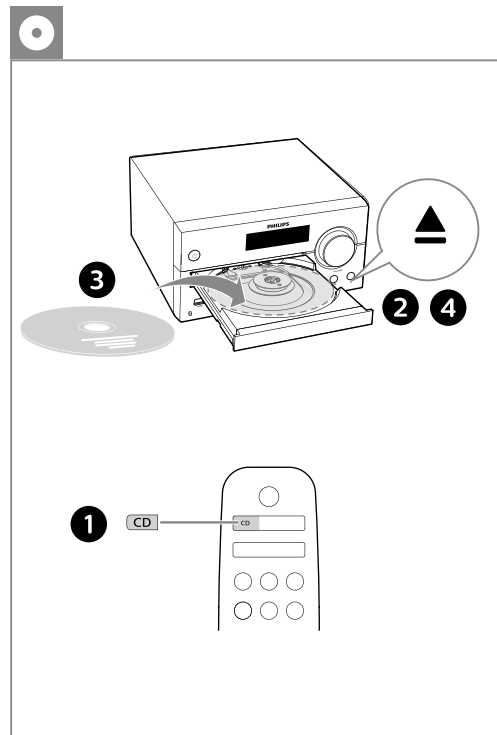
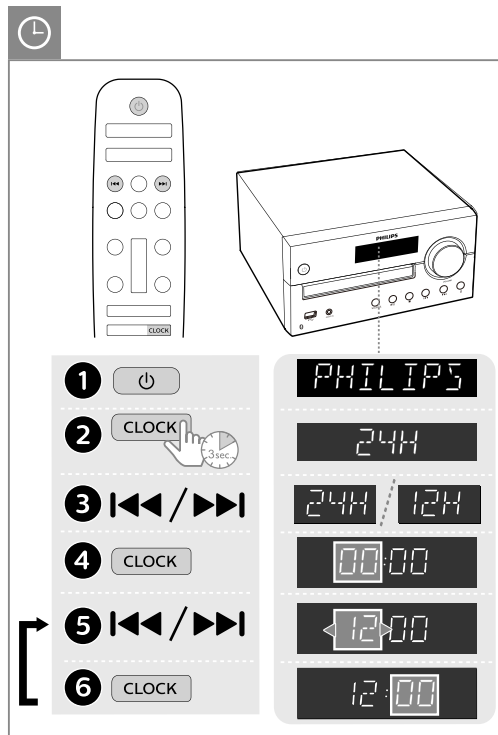

296.00 mm

210.00 mm

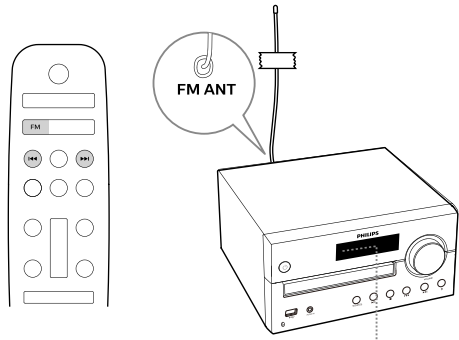

1 FM

2 A |◀◀/▶▶|

2 B |◀◀/▶▶|

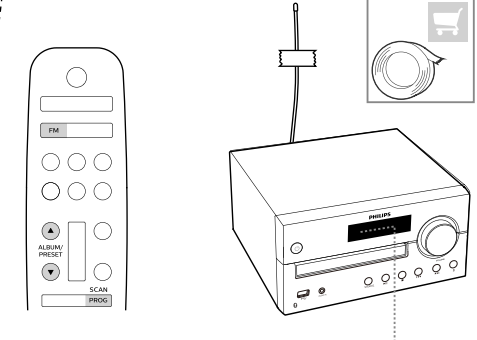

1 FM

2 SCAN
PROG

3 ▲/▼

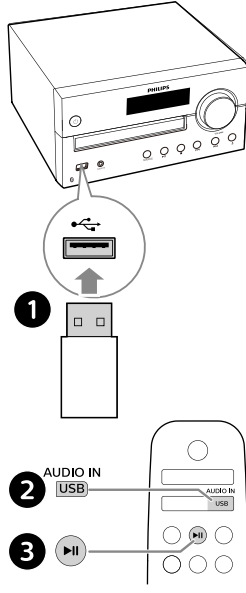

1

2 AUDIO IN
USB

3 |▶|

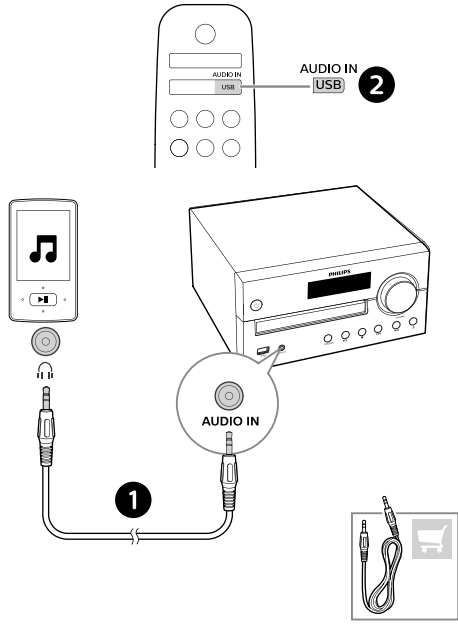

1

2 AUDIO IN
USB

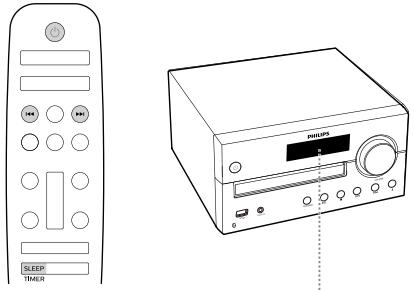

1 [Power]

2 SLEEP
TIMER

3 |◀◀/▶▶|

4 SLEEP
TIMER

5 |◀◀/▶▶|

6 SLEEP
TIMER

7 |◀◀/▶▶|

8 SLEEP
TIMER

9 |◀◀/▶▶|

10 SLEEP
TIMER

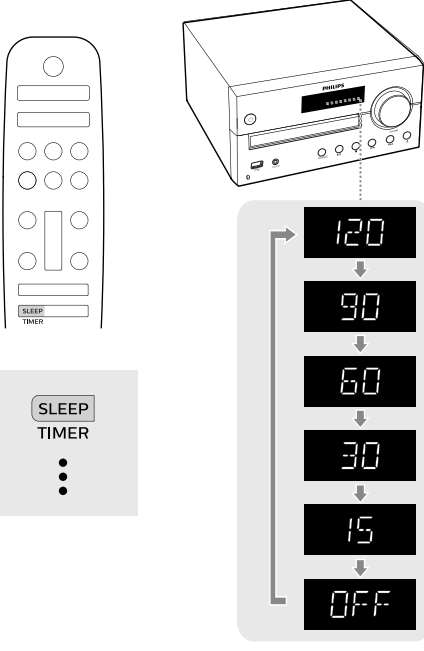

SLEEP
TIMER

120

90

60

30

15

00

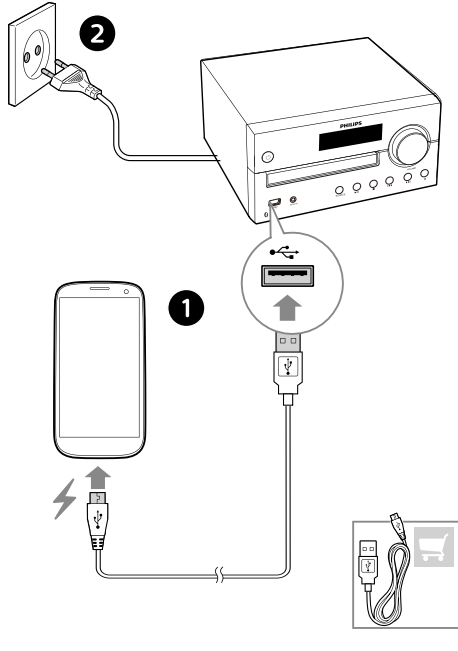

2

1