



# CR-430

denver.eu

08/22



FR

Cet appareil est recyclable

À DÉPOSER EN MAGASIN



OU

À DÉPOSER EN DÉCHÈTERIE



Points de collecte sur [www.quefairedemesdechets.fr](http://www.quefairedemesdechets.fr)  
Privilégiez la réparation ou le don de votre appareil !

## Safety information

Please read the safety instructions carefully before using the product for the first time and keep the instructions for future reference.

1. This product is not a toy. Keep it out of reach of children.
2. Keep product out of the reach of children and pets to avoid chewing and swallowing.
3. Never use old and new batteries or different types of batteries together. Remove the batteries when you are not using the system for a longer period of time. Check the polarity (+/-) of the batteries when inserting them in the product. Wrong positioning can cause an explosion. Batteries are not included.
4. Product operating and storage temperature is from 0 degree Celsius to 40 degree Celsius. Under and over this temperature might affect the function.
5. Never open the product. Touching the inside electrics can cause electric shock. Repairs or service should only be performed by qualified personnel.
6. Do not expose to heat, water, moisture, direct sunlight!
7. Please protect your ears against loud volume. Loud volume can damage your ears and risk in hearing loss.
8. The unit is not waterproof. If water or foreign objects enter the unit, it may result in fire or electric shock. If water or a foreign object enters the unit, stop use immediately.
9. The direct power cable is used as disconnect device, the disconnect device shall remain readily operable. So, make sure there is space around the power outlet for easy access.
10. Do not use non original accessories together with the product as this can make the product functionality abnormal.

# LED Clock Radio Dual Alarm

## Instruction Manual

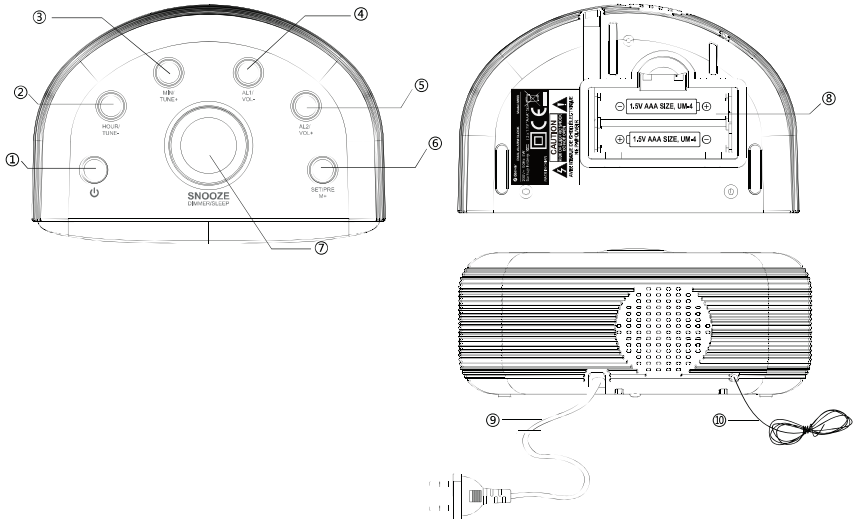

### Buttons

1. 
2. “HOUR / TUNE-” button
3. “MIN / TUNE+” button
4. “AL 1 / VOL-” button
5. “AL 2 / VOL+” button
6. “SET / PRE M+” button
7. “SNOOZE / DIMMER / SLEEP” button
8. Battery compartment
9. AC power cord – connect to correct power voltage.
10. Antenna – extend and reposition for better radio reception.

This clock radio is AC powered. Use two 'AAA' size batteries to keep accurate time during temporary power interruption. Insert batteries by matching the polarity (+/-) markings in the battery compartment (8).

Plug power cable into electrical outlet with correct voltage. Check rating labels on the radio. **DO NOT PLUG THE RADIO INTO AN ELECTRICAL OUTLET IF YOU ARE UNSURE OF THE VOLTAGE.**

Note: The time and alarms can only be set when the radio is turned off.





#### SET TIME

To	Press
Set time	Press and hold "SET / PRE M+" (6) button until digits flash.
Set hour	"HOUR / TUNE-" button (2)
Set minute	"MIN / TUNE+" button (3)
Confirm	"SET / PRE M+" button (6)

#### SET ALARM

To	Press
Set alarm time 1	"AL 1 / VOL-" button (4)
Set alarm time 2	"AL 2 / VOL+" button (5)
Set alarm hour	"HOUR / TUNE-" button (2)
Set alarm minute	"MIN / TUNE+" button (3)

## ACTIVATE ALARM

To	Press
Alarm with buzzer	“AL 1 / VOL-” button (4) or “AL 2 / VOL+” button (5) once, buzzer indicator   on
Alarm with radio	“AL 1 / VOL-” button (4) or “AL 2 / VOL+” button (5) twice, radio indicator   on
Deactivate alarm	“AL 1 / VOL-” button (4) or “AL 2 / VOL+” button (5) until no indicators
Turn off alarm / radio	“  ” button (1)
Snooze	“SNOOZE/DIMMER/SLEEP” button (7)

## DISPLAY BRIGHTNESS

Press “SNOOZE/DIMMER/SLEEP” button (7) to adjust display brightness.

## General Operations

To	Press
Turn on / off	“  ” button (1)
Automatic Tuning	Press and hold “HOUR / TUN-” button (2) or “MIN / TUN+” button (3) for 3s.
Manual Tuning	“HOUR / TUN-” button (2) or “MIN / TUN+” button (3) repeatedly
Set preset stations	After selecting a station, press and hold “SET / PRE M+” button (6) until display flashes. Then press “HOUR / TUN-” button (2) or “MIN / TUN+” button (3) to select station number (1-10). Press “SET / PRE M+” button (6) again to confirm.

Recall preset station

Press "SET / PRE M+" button (6) to select a preset station.

-----  
Sleep mode

-----  
With the radio on, press "SNOOZE/  
DIMMER/SLEEP" button (7) repeatedly  
to set the sleep timer (10 - 90 minutes).  
-----

Please notice - All products are subject to change without any notice.  
We take reservations for errors and omissions in the manual.

ALL RIGHTS RESERVED, COPYRIGHT DENVER A/S



denver . eu



Electric and electronic equipment contains materials, components and substances that can be hazardous to your health and the environment, if the waste material (discarded electric and electronic equipment) is not handled correctly.

Electric and electronic equipment is marked with the crossed out trash can symbol, seen above. This symbol signifies that electric and electronic equipment should not be disposed of with other household waste, but should be disposed of separately.

All cities have established collection points, where electric and electronic equipment can either be submitted free of charge at recycling stations and other collection sites, or be collected from the households. Additional information is available at the technical department of your city.

Hereby, Denver A/S declares that the radio equipment type CR-430 is in compliance with Directive 2014/53/EU. The full text of the EU declaration of conformity is available at the following internet address: [denver.eu](http://denver.eu) and then click the search ICON on topline of website. Write model number: CR-430. Now enter product page, and RED directive is found under downloads/other downloads.  
Operating Frequency Range: FM 87.5-108MHz  
Max Output Power: 0.4W

DENVER A/S  
Omega 5A, Soeften  
DK-8382 Hinnerup  
Denmark  
[www.facebook.com/denver.eu](http://www.facebook.com/denver.eu)