

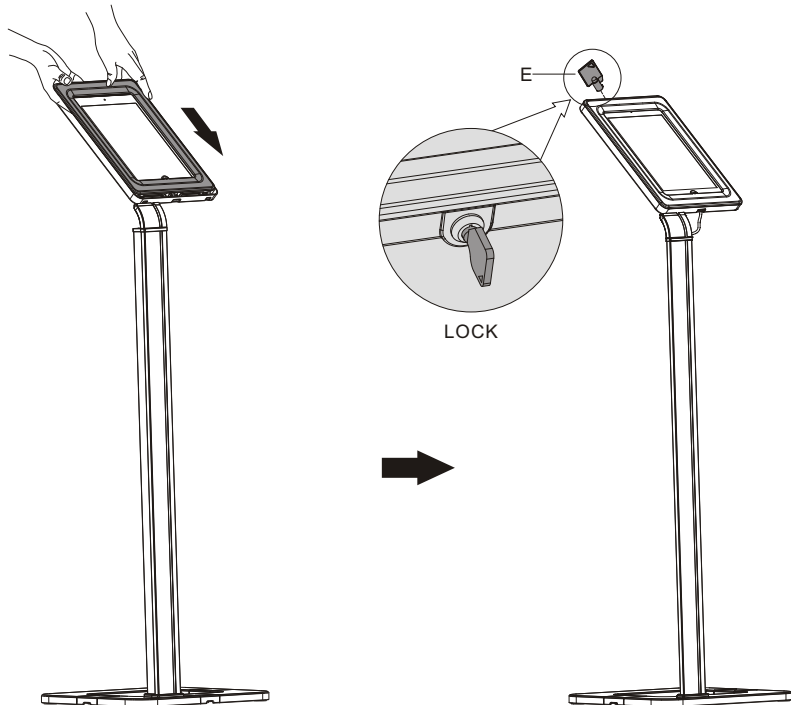

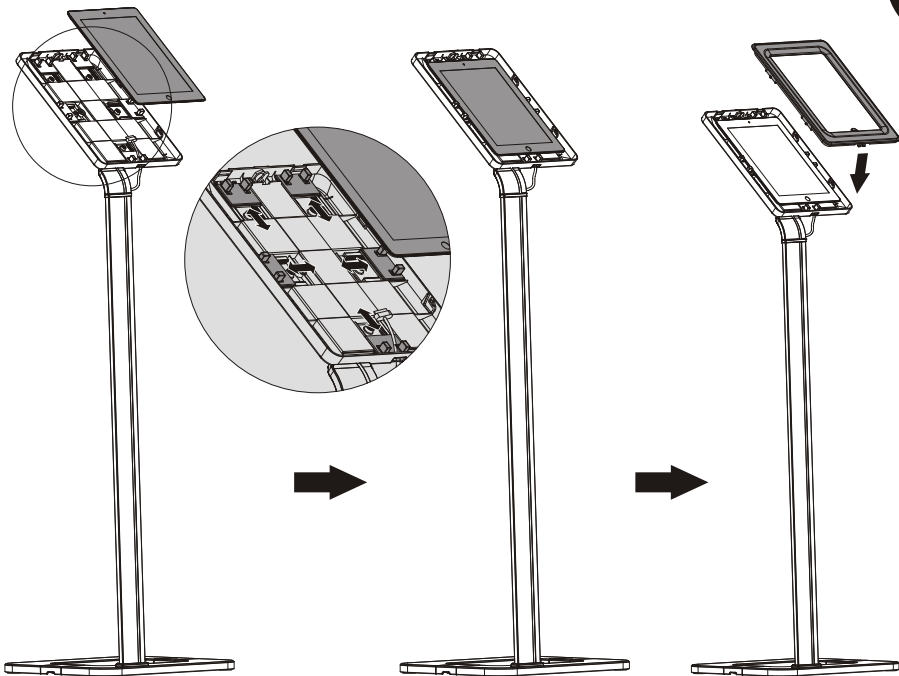











9



# PAD15-01/PAD15-02 Installation Instruction



ITEM	DESCRIPTION/PART NO.	QUANTITY	ITEM	DESCRIPTION/PART NO.	QUANTITY
A	 plastic case	1	G	 M6x16	4
B	 base	1	H	 M6x8	2
C	 pole	1	I	 M5x12	4
D	 bracket	1	J	 Concrete anchor	3
E	 key	2	K	 5mm Allen key	1
F	 connecting piece	1	L	 ST5.5x38	3
			M	 D5 washer	3

