

The following features are available in this PDF document.



Quick Keyword Search

Enter the keyword in the search box and hit the search button



Quick Jump between Chapters

Click the title of a specific chapter on the Contents to jump to it

*Reading software such as Adobe Reader is needed to support the functions above.



SMOOTH 5

User Guide

Contents

■ Product List	
Product List	1
■ Get to Know SMOOTH 5	
Get to Know SMOOTH 5	3
■ Battery and Charging	
Battery and Charging	4
■ Mounting and Balancing	
Mounting the Phone	5
Installing the Fill Light	7
Balancing	8
■ How to Use the Gimbal	
Buttons/Indicator Lights/Ports Introduction	9
Gimbal Modes Description	12
Manual Reposition	15
Standby Mode	15
Packing	15
■ How to Use the App	
Download the App	16
How to Connect	16
App Features Description	17
■ Firmware Upgrade and Calibration	
Firmware Upgrade	18
Calibration	20

■ Product Specifications

■ Disclaimer and Warning

Reading Tips 24

Warnings 24

Safe Operation Guidelines 25

■ Warranty Card

Warranty Period 27

Warranty Exclusions 27

Warranty Claim Procedure 27

■ Contact Card

Product List

Before using this product, please check carefully that all the following items are included in the product package. In case that any item is found missing, please contact ZHIYUN or your local selling agent.



SMOOTH 5 x1



Tripod x1

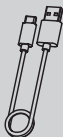

USB Type-C Cable x1



Protective Bag x 1*

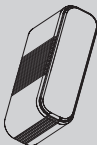

Fill Light* x1

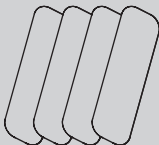

Fill Light Filters* x4



Wrist Strap* x1



Membership Card* x1



Quick Start Guide x1

Items marked “***” are included in SMOOTH 5 COMBO.

Get to Know SMOOTH 5

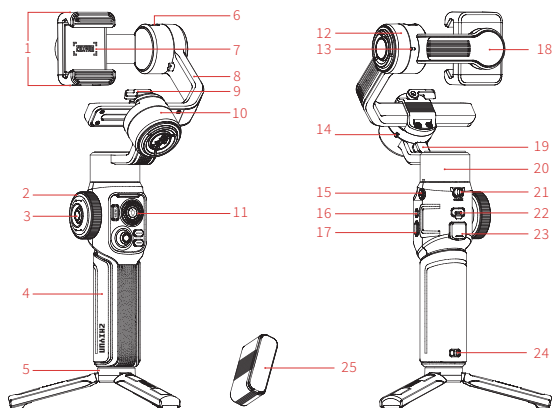

1. Magnetic Fill Light Slot
2. Focus/Zoom Control Wheel
3. Focus/Zoom Switch
4. Handle
5. Tripod
6. Mobile Phone Charging Port
7. Phone Clamp
8. Roll Axis Arm
9. Roll Axis Arm Latch
10. Roll Axis Motor
11. Indicator Lights/Control Panel
12. Tilt Axis Motor
13. Tilt Axis Lock Pin
14. Roll Axis Lock Pin
15. 1/4" Threaded Hole
16. Power Button
17. FN Button
18. Phone Clamp Rotate Axis
19. Pan Axis Arm
20. Pan Axis Motor
21. Pan Axis Latch
22. Type-C Charging/Firmware Upgrade Port
23. Trigger Button
24. Wrist Strap Hole
25. TransMount SMOOTH 5 Magnetic Fill Light (Included in SMOOTH 5 Combo)

Battery and Charging

SMOOTH 5 is equipped with built-in battery. When using SMOOTH 5 for the first time, please fully charge the battery to activate them and to ensure the proper function of the gimbal.

Charging method: Use provided USB Type-C cable to connect the USB charger (not provided, recommend chargers that meet the USB Power Delivery Specification, supports 18W at most) to the charging port of SMOOTH 5. When the indicator light stays solid, the charging is complete.

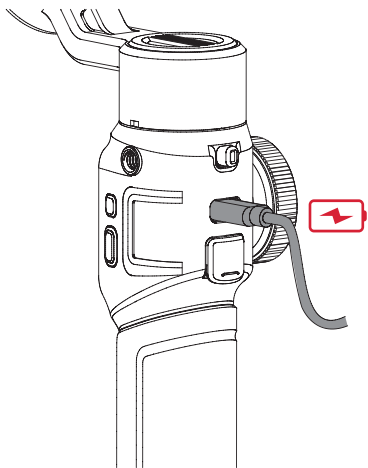

Mounting the Phone

1. Unlock the tilt axis, roll axis, and pan axis, expand the SMOOTH 5.

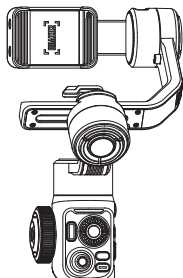
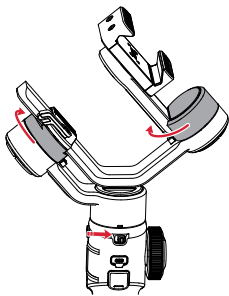

⚠ When using, please rotate in the correct direction as shown in the image to prevent the lock pin from damaging.

2. Mount the mobile phone onto the phone clamp. You can mount the phone in portrait mode or landscape mode according to the actual filming scenario.

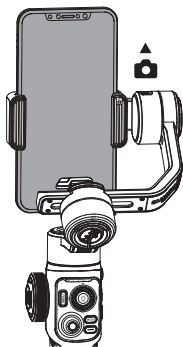

Portrait Mode Installation

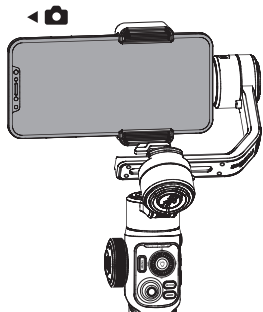

Landscape Mode Installation

1. Rotate the phone clamp to switch between portrait/landscape mode. When using, please rotate in the correct direction.
2. When mounting the mobile phone, please note the installation direction of the phone cameras as shown in the image.
3. When mounting the mobile phone, please make sure that the entire mobile phone is fixed in the phone clamp firmly.
4. Before powering on SMOOTH 5, please mount the mobile phone and balance the gimbal.

Installing the Fill Light

If you purchase SMOOTH 5 Combo, the package will come with the magnetic fill light. Install the magnetic fill light at the front or rear camera according to the actual filming scenario and make sure a firm installation.

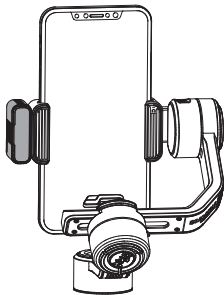

Fill Light at Front Camera

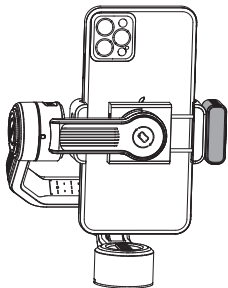

Fill Light at Rear Camera

 You can change the fill light filter according to the actual filming scenario. When using the fill light, please avoid staring directly at the light.

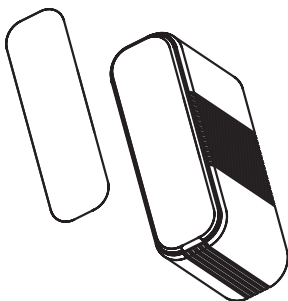

Balancing

Mounting in the portrait mode

1. Unlock the roll axis arm ①, push the arm to move left or right ② until the phone is steady and is at almost level with the ground ③. Tighten the latch ④.

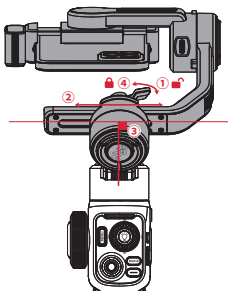

2. Move the mobile phone left or right ① until the phone is steady and is at almost level with the ground ②.

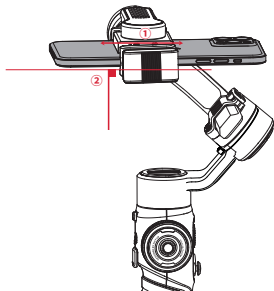

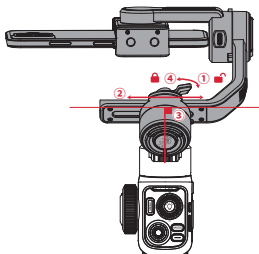

Mounting in the landscape mode

1. Unlock the roll axis arm ①, push the arm to move left or right ② until the phone is steady and is at almost level with the ground ③. Tighten the latch ④.

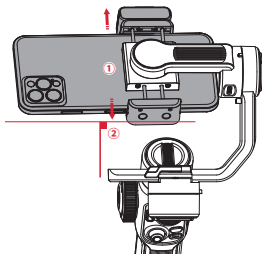

2. Move the phone clamp forward or backward ① until the phone is steady and is at almost level with the ground ②.



 The balance state of the mobile phone will affect the gimbal runtime. The gimbal can work normally if unbalanced, but it will consume more battery power and weaken the motor strength.

Buttons/Indicator Lights/Ports Introduction

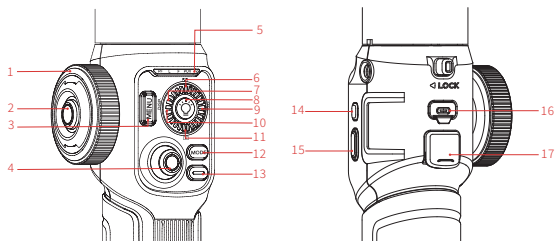

1

Focus/Zoom Control Wheel

Rotate the wheel to control focus/zoom in StaCam app.
Rotate the wheel to control zoom in ZY Cami app.



2

Focus/Zoom Switch

Single press: Switch between focus/zoom in StaCam app.



3

MENU Button

Single press:
Enter the SMART menu/return to the filming interface in ZY Cami app.
Press to return to the filming interface in StaCam app.



4

Joystick

Push the joystick up/down/left/right to control the gimbal to rotate.



5

Gimbal Mode/Battery Level/Status Indicator Light

Gimbal Mode: Indicator light of each mode stays on to indicate the current mode. (F light flashes indicating the Go mode)
Battery Level (single press the gimbal power button when powered on): flashing red PF light indicates low battery.

One flashing white indicator light: 0-20% battery level.
 Two flashing white indicator lights: 20%-40%
 Three flashing white indicator lights: 40%-60%
 Four flashing white indicator lights: 60%-80%
 Five flashing white indicator lights: 80%-100%
 Status: Five slow flashing light indicates standby.
 Five quick flashing light indicates upgrade failure.
 Five lights flashing one by one from left to right indicates that the upgrade is in progress.



Resolution Selection Button

Single press: Enters resolution adjustment interface in ZY Cami/StaCam app.



Adjustment Wheel

Rotate the wheel in certain menus in ZY Cami/StaCam app to select parameters/functions.



Fill Light Button

Single press: For confirming in certain menus of ZY Cami/StaCam app.
 Double press: Start filming with the chosen mode in ZY Cami/StaCam app.
 Press and hold: Power on/off magnetic fill light. (Rotate the adjustment wheel to control the brightness when powered on)



ISO/Exposure Adjustment Button

Single press: Disabled in ZY Cami app.
 Switch among shutter, ISO and white balance in StaCam app.









DISP Button

Single press: Disabled in ZY Cami app.
 Show/hide screen icons in StaCam app.



Photo Album Button

Single press: Open/close photo album in ZY Cami/StaCam app.

- 12**  **Mode Switch**
Single press: Switch gimbal modes (PF-L-F-POV-V)
Double press: Return to previous mode
- 13**  **Photo/Video Button**
Single press: Start filming with the chosen mode in ZY Cami/ StaCam app.
Double press: Switch front/rear camera in ZY Cami.
Switch among wide-angle, super-wide-angle, telephoto, auto, front camera in StaCam app.
- 14**  **Power Button**
Single press: See battery level
Press and hold: Power on/off the gimbal
- 15**  **FN Button**
Single press: Disabled in ZY Cami app.
Enter footage settings menu in StaCam app.
Press five times: Reset Bluetooth
- 16**  **Type-C Charging/Firmware Upgrade Port**
Charge the gimbal/connect to computer for firmware upgrade via this port.
- 17**  **Trigger Button**
Single press: Enable/disable SmartFollow in ZY Cami app
Double press: Reposition
Triple press: 180° rotation for pan axis
Press and hold: Enter Go Mode

-  ① When connected via Bluetooth, SMOOTH 5 is able to control the native phone camera without ZY Cami/StaCam app. This function is available with a mobile phone which supports photo-taking using the volume button. For detailed information, visit the official website of ZHIYUN (www.zhiyun-tech.com) and check the “SMOOTH 5 Smartphone Compatibility List”.
- ② Some of the functions above for the buttons are only available when the phone is connected to the gimbal and using ZY Cami/StaCam app. It is recommended to download ZY Cami/StaCam app and use with SMOOTH 5.
- ③ StaCam is an app for professional filming with advanced features such as guides, focus peaking, zebra pattern, LUT, etc. You can choose the app that best fits your filming scenario.

Gimbal Modes Description

Single or double press the MODE button to switch modes.

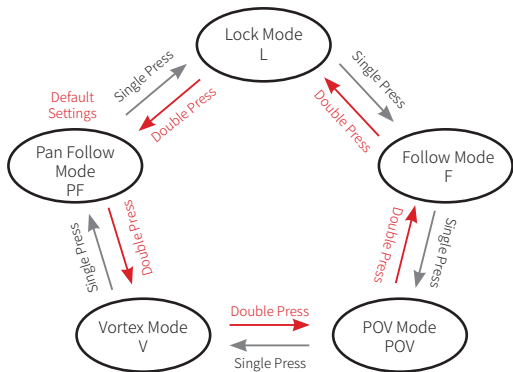

💡 Motors circled in red will follow the movement of the gimbal, while motors circled in grey are locked.

Pan Follow Mode (PF):

The tilt and roll axis motors are locked and the pan axis follows the movement of the gimbal handle. Push the joystick up/down and left/right to control the tilt axis and pan axis.

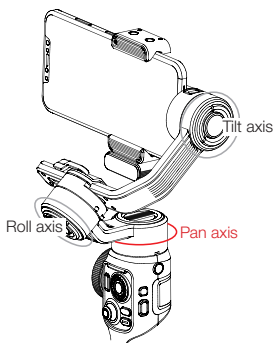

Lock Mode (L):

The three motors are all locked and won't follow the movement of the gimbal handle. Push the joystick up/down and left/right to control the tilt axis and pan axis.

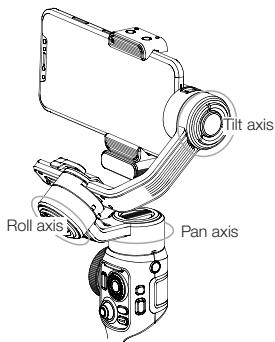

Follow Mode (F):

The roll axis motor is locked. The tilt axis and the pan axis motor follow the movement of the gimbal handle. Push the joystick up/down and left/right to control the tilt axis and pan axis.

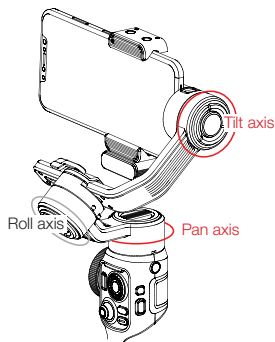

Point of View Mode (POV):

The three motors all follow the movement of the gimbal handle.

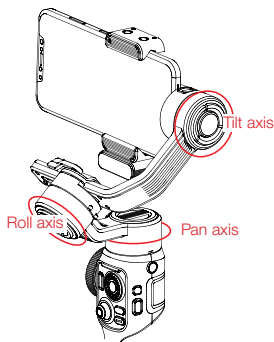

Vortex mode (V):

The tilt axis motor rotates upward by 90°, and the tilt axis, roll axis, and pan axis motors follow the rotation of the handle. Push the joystick to the left/right to control the rotation of the pan axis.

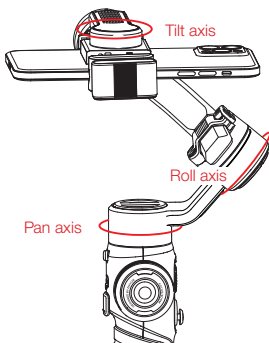

Go Mode (GO):

The camera pans and tilts following the movement of the gimbal at fast speed while the roll axis is locked.

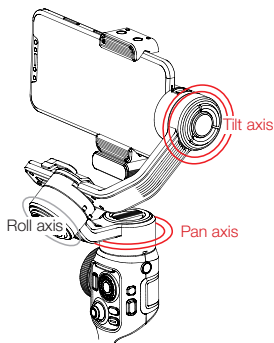

Manual Reposition

In Pan Follow mode (PF) and Lock mode (L), the camera can be rotated by a certain angle by hand. Hold it for 2s and the camera angle will be fixed at that angle after you release the camera.

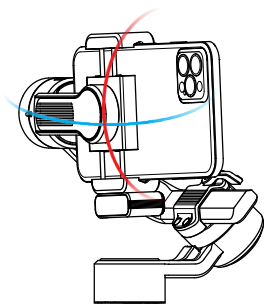

Standby Mode

When SMOOTH 5 is powered on, rotate the roll axis or pan axis manually until the axis triggers the built-in lock device, then SMOOTH 5 will enter standby mode automatically. Unlock the roll axis and pan axis to wake up the gimbal.

Packing

Rotate the gimbal to its storage state as shown in the image.

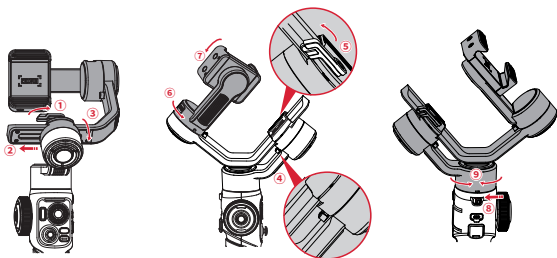

Download the App



Scan the QR code on the left (Android 7.0 and above, iOS 10.0 and above required) or search "ZY Cami" in App Store or Google Play to download.

- ① Users can make better use of the various functions of SMOOTH 5 with the dedicated app "ZY Cami".
- ② ZY Cami is subject to update. Please always refer to the latest version.

How to Connect

1. Power on SMOOTH 5 and turn on Bluetooth on the mobile phone.
2. Launch the "ZY Cami" app. Tap the camera icon in the upper left corner of the home screen to open the device list and select the SMOOTH 5 device you wish to connect (the SMOOTH 5 Bluetooth name can be checked on the tilt axis arm USER ID: XXXX).
3. Activation on the ZY Cami app is required if the SMOOTH 5 is being used for the first time. Internet connection is required. After the activation succeeds, you can enter the camera interface of ZY Cami App.

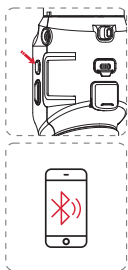

①



②

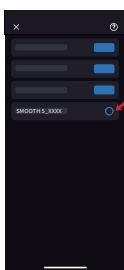

③

App Features Description



💡 For more details of the “ZY Cami” app features, please visit the official website of ZHIYUN (www.zhiyun-tech.com) and watch SMOOTH 5 video tutorials.

Firmware Upgrade

Method 1:

1. Connect the Type-C charging/firmware upgrade port at the side of the SMOOTH 5 vertical arm to the computer with the USB Type-C USB cable, power on SMOOTH 5, and enter standby mode.
2. Visit the official website of ZHIYUN (www.zhiyun-tech.com), go to the SMOOTH 5 product page, click "Download", find the USB driver, the ZHIYUN calibration upgrade tool, and the firmware and download. (USB drivers are not required for Mac OS systems)
3. Install the driver and the software, unzip the firmware for the documents with the ".ptz" file extension.
4. Open "Zhiyun Gimbal Tools", select the corresponding port, click "Open", click "Firmware Upgrade". Click "Browse" under "Path" to select the latest firmware downloaded (with the ".ptz" file extension), and click "Upgrade" at the bottom to upgrade firmware. When the firmware upgrade finishes, SMOOTH 5 will be automatically turned off.

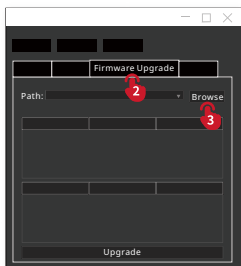
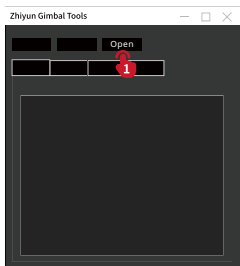
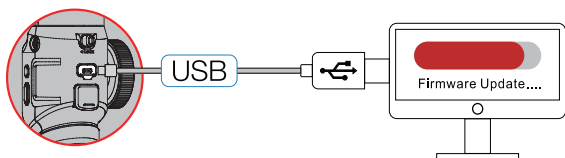

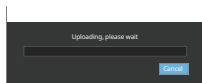
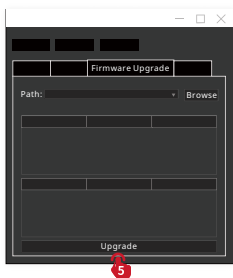
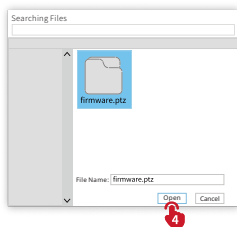

Method 2:

Connect SMOOTH 5 to the “ZY Cami” app. If “ZY Cami” app prompts to upgrade the firmware, follow the instructions to upgrade. Internet connection is required.

- 💡 Before upgrading the firmware, please ensure that the SMOOTH 5 has more than 50% power remaining. Do not exit the app interface or access in the background during the upgrading process. Pay attention to the prompts on the app.

Calibration

Calibration Reason	How to calibrate
<ol style="list-style-type: none"> 1. A slight deviation is found in the tilt angle of the mobile phone in level position after power-on. 2. A slight deviation is found in the roll angle of the mobile phone in level position after power-on. 3. Frequent small angle correction is found when the mobile phone is in a level position when the gimbal stays still. 	Gimbal auto-calibration
<ol style="list-style-type: none"> 1. A slight deviation is found in the level position after the auto-calibration of the gimbal. 2. The gimbal has not been used for a long time. 3. The gimbal has undergone a significant temperature difference. 	Six-side calibration

Six-side calibration:

1. Install SMOOTH 5 onto the tripod and connect to the ZY Cami App.
2. Go to the settings of the app and select "auto-calibration". The SMOOTH 5 will enter the calibration automatically. You can check the progress at the prompt of the app.

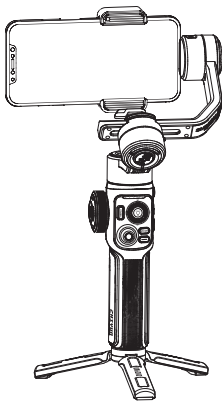

Six-side calibration:

You can use "Zhiyun Gimbal Tools" to perform six-side calibration for SMOOTH 5.

1. Connect the charging/firmware upgrade port of the gimbal to the computer with the Type-C USB cable. Power on the gimbal and enter standby mode.
2. Open "Zhiyun Gimbal Tools", click "open" on the top, and click "calibration" on the bottom. Please conduct the process according to the following steps. A "√" mark will appear after the calibration is complete.

STEP 1

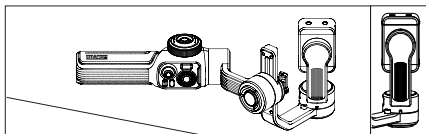

STEP 2

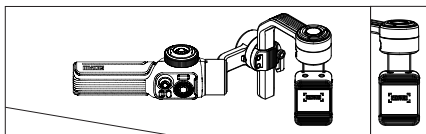

STEP 3

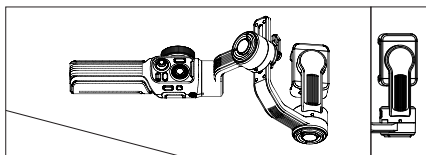

STEP 4

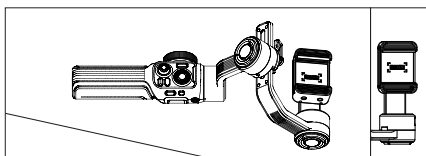

STEP 5

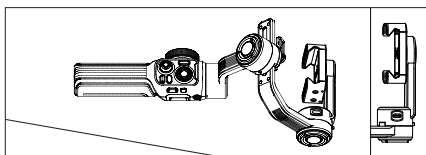

STEP 6

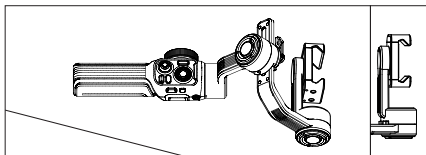

💡 Please refer to the six-side calibration steps above. In simple terms, six-side calibration is to place all six sides of the tilt axis in vertical to a level surface respectively.

Product Model: SM115

	Min.	Standard	Max.	Remark
Operation Voltage	6.5V	7.4V	8.4V	
Operation Current	70mA	-	3000mA	
Charging Voltage	5V		9V	
Charging Current	-		1600mA	
Output Voltage	-	5V	-	
Output Current	-	-	1A	
Built-in Battery Capacity	-	2600mAh	-	
Following Deviation in Static State	$\pm 0.01^\circ$		$\pm 0.04^\circ$	
Following Deviation in Motion State	$\pm 0.05^\circ$	$\pm 0.1^\circ$	$\pm 0.3^\circ$	
Tilt Mechanical Range	-140°	349°	209°	Including storage state
Roll Mechanical Range	-90°	300°	210°	Including storage state
Pan Mechanical Range	-180°	360°	180°	
Controllable Tilt Angle	-90°	-	+170°	
Controllable Roll Angle	-50°	-	+50°	
Controllable Pan Angle	-180°	-	+180°	
Operation Temperature	-10°C	25°C	45°C	
Battery Runtime	4.5h	-	25h	Lab Data 1
Charging Time	2h	-	4h	Lab Data 2
Charging Ambient Temperature	0°C	25°C	45°C	
Compatible Smartphone Weight	150g	-	300g	

	Min.	Standard	Max.	Remark
Horizontal Arm Adjustment Range	-12mm	47mm	35mm	
Mounting Clamp Supporting Range	50mm	-	90mm	
Compatible Models	Smartphones that their width is within the holder's capable width.			
Smartphone Thickness	< 10mm			
Bluetooth	Bluetooth 4.2			
EIRP	<3dBm			
Operation Frequency	2.402GHz~2.480GHz			

"Lab Data 1": The data is collected under the below conditions: a specified temperature of 25°C ; the gimbal has been balanced and mounted with an iPhone XR. When the fill light is set at the highest brightness level, the runtime of the gimbal is 4.5h. When the fill light is off and the gimbal is under standby state, the runtime is 25h.

"Lab Data 2": When charging with a 15W Fast Charge at a specified temperature of 25°C , the charging time is 2h. When charging with a 5V/2A rated power adapter at a specified temperature of 25 °C , the charging time is 4h. The actual charging time varies with environmental factors. In addition, the lower the temperature, the longer the charging time.

All the data in this guide is collected from internal experiments of ZHIYUN laboratories. Under different scenarios, the above data is subject to a margin of error. Please refer to actual use of this product.

Thank you for purchasing SMOOTH 5. The information contains herein affects your safety, legitimate rights and obligation. Please read this instruction carefully to ensure proper configuration before use. Failure to read and follow this instruction and warnings herein may result in serious injury to you or bystanders, or damage to your device or property. Guilin Zhishen Information Technology Co., Ltd (hereinafter referred to as "ZHIYUN") reserves all rights for final explanation on this instruction and other documents related to SMOOTH 5. The information is subject to update without notice. Please visit www.zhiyun-tech.com to obtain the latest product information.

By using this product, you hereby signify that you have read this document carefully and that you understand and agree to abide by the terms and conditions herein. You agree that you are solely responsible for your own conduct while using this product, and for any consequences thereof. You agree to use this product only for purposes that are proper and in accordance with all terms, precautions, practices, policies and guidelines ZHIYUN has made and may make available.

ZHIYUN accepts no liability for damage, injury or any legal responsibility incurred directly or indirectly from the use of this product. Users shall observe safe and lawful practices including, but not limited to, those set forth herein.

ZHIYUN™ is the trademark of Guilin Zhishen Information Technology Co., Ltd and its affiliates. All product names or trademarks referred to herein are trademarks or registered trademarks of their respective holders.

Reading Tips

Legends



Hints and Tips



Important

Warnings

Read the ENTIRE User Guide to become familiar with the features of this product before operating. Failure to operate the product correctly can result in damage to the product or personal property and cause serious injury. This is a sophisticated product. It must be operated with caution and common sense and requires some basic mechanical ability. Failure to operate this product in a safe and responsible manner could result in injury or damage to the product or other property. This product is not intended for use by children without direct adult supervision. DO NOT use with incompatible components or in any way otherwise as mentioned or instructed in the product documents provided by ZHIYUN. The safety guidelines herein contain instructions for safety, operation and maintenance. It is essential to read and follow all of the instructions and warnings in the User Guide, prior to assembly, setup or use, in order to operate the product correctly and avoid damage or serious injury.

Safe Operation Guidelines

WARNING:

1. Never allow the product to come into contact with any liquid. Never immerse the product in water or make it get wet. Never use the product in the rain or a humid environment. Corrosion reaction may occur when the interior of the product is exposed to water, which may cause the battery to ignite spontaneously and may even cause an explosion.
2. If the product catches fire, please use water or water mist, sand, fire blanket, dry powder, carbon dioxide fire extinguisher immediately to put out the fire. Please choose the method according to the actual situation.
3. Please use the product in an environment with a temperature between -10°C and 45°C .
4. It is forbidden to disassemble the product in any way. If the battery is pierced during disassembly, it will cause the electrolyte inside the battery to leak or even cause fire or explosion.
5. Mechanical impact, rolling, or throwing of the product is prohibited. Do not place heavy objects on the product.
6. Do not heat the product. Do not place the product in a microwave oven or pressure cooker.
7. It is forbidden to place the product near a heat source (stove or heater, etc.) or inside the car in hot weather. Do not store the product in an environment above 45°C . The ideal temperature of storage is 22°C to 28°C .
8. Do not store the battery for a long time after it is completely discharged to avoid the battery entering the over-discharged state and causing damage to the battery cell, and it will not be able to resume use.

BE CAREFUL:

1. SMOOTH 5 is a high-precision control device. Damage may be caused to SMOOTH 5 if dropped or subject to external force, and this may result in malfunction.
2. Make sure the rotation of the gimbal axes is not blocked by external force when SMOOTH 5 is turned on.
3. SMOOTH 5 is not waterproof. Prevent contacts of any kind of liquid or cleaner with the SMOOTH 5. It is recommended to use dry cloth for cleaning.
4. Protect SMOOTH 5 from dust and sand during use.

CAUTION:

1. After the charging is complete, disconnect the product from the charger.
2. If you do not use the product for more than 10 days, please charge/discharge the battery to 40%-65% and store it to extend the battery life.

3. Recharge and discharge every 3 months to keep the battery active.
4. Keep the handle stable when powering on the SMOOTH 5. Shakiness during power-on may fail to start.

Warranty Period

1. Customers are entitled to replacement or free repair service in case of quality deficits found in the product within 15 days upon receipt of the product.
2. Customers are entitled to free repair service from ZHIYUN for any product proven defective in material or workmanship that results in product failure during normal consumer usage and conditions within the valid warranty period, which is 12 months counting from the date of selling. However, warranty period varies by product component and country of purchase. Please contact our after-sales service team on ZHIYUN official website or your place of purchase for detailed warranty information.

Warranty Exclusions

1. Products subjected to unauthorized repair, misuse, collision, neglect, mishandling, soaking, accident, and unauthorized alteration.
2. Products subjected to improper use or whose labels or security tags have been torn off or altered.
3. Products whose warranty has expired.
4. Products damaged due to force majeure, such as fire, flood, lightning, etc.

Warranty Claim Procedure

1. If failure or any problem occurs to your product after purchase, please contact a local agent for assistance, or you can always contact ZHIYUN's customer service through email at info@zhiyun-tech.com or website at www.zhiyun-tech.com.
2. Your local agent or ZHIYUN's customer service will guide you through the whole service procedure regarding any product issue or problem you have encountered. ZHIYUN reserves the right to reexamine damaged or returned products.

Customer Information

Customer Name:

Phone Number:

Address:

Sales Information

Sales date:

Product Serial Number:

Distributor Name:

Distributor's Contact Number:

First Maintenance Record

Service Date:

Repairman Signature:

Cause of Problem:

Service Result:

Solved

Unsolved

Refunded/Replaced



Website



Weibo



Vimeo



Google+



Facebook
(Zhiyun Support)



Facebook
(Zhiyun Tech)



Youku



Youtube



Wechat



Instagram

Tel: +86 400 900 6868

USA Hotline: +1 808-319-6137,9:00-18:00 GMT-7,Mon-Fri

Europe Hotline: +49 (0) 61018132180,10:00-17:00 GMT+1,Mon-Fri

Web: www.zhiyun-tech.com

E-mail: info@zhiyun-tech.com

Address: 09 Huangtong Road, Tieshan Industrial Zone, Qixing District, Guilin, 541004, Guangxi, China

Certificate of Quality

This product is confirmed to meet quality standards and permitted for sale after strict inspection.

QC Inspector: _____



For full product information, please visit ZHIYUN's official website: Content on www.zhiyun-tech.com is subject to update without notice.

ZHIYUN™ is a trademark of ZHISHEN

All product names or brands referred to hereunder may be trademarks or registered trademarks of their respective holders.

Copyright © 2021 ZHISHEN. All rights reserved.

FCC Caution.

This device complies with part 15 of the FCC Rules. Operation is subject to the following two conditions: (1) This device may not cause harmful interference, and (2) this device must accept any interference received, including interference that may cause undesired operation.

Any Changes or modifications not expressly approved by the party responsible for compliance could void the user's authority to operate the equipment.

Note: This equipment has been tested and found to comply with the limits for a Class B digital device, pursuant to part 15 of the FCC Rules. These limits are designed to provide reasonable protection against harmful interference in a residential installation. This equipment generates uses and can radiate radio frequency energy and, if not installed and used in accordance with the instructions, may cause harmful interference to radio communications. However, there is no guarantee that interference will not occur in a particular installation. If this equipment does cause harmful interference to radio or television reception, which can be determined by turning the equipment off and on, the user is encouraged to try to correct the interference by one or more of the following measures:

- Reorient or relocate the receiving antenna.
- Increase the separation between the equipment and receiver.
- Connect the equipment into an outlet on a circuit different from that to which the receiver is connected.
- Consult the dealer or an experienced radio/TV technician for help.

RF Exposure:

The device has been evaluated to meet general RF exposure requirement, The device can be used in portable exposure condition without restriction Federal Communication Commission (FCC) Radiation Exposure Statement Power is so low that no RF exposure calculation is needed.

ZHIYUN-TECH.COM