



# **DigiFrame 1587 8GB**

## **User Manual**

## Cautions

### Precautions and maintenance

- For indoor use only
- To avoid risk of fire or electric shock, do not expose the unit to moisture or condensation.
- To avoid overheating, do not block the ventilation holes on the back of the Digital Photo Frame.
- Keep the Digital Photo Frame out of direct sunlight.
- Always use the eject buttons on the memory storage card slots to remove the storage cards.
- Do not dismantle the Digital Photo Frame. There is a risk of electric shock and there are no user-serviceable parts inside. Dismantling the Digital Photo Frame will void your warranty.

### Cleaning the LCD Screen

- Treat the screen carefully. Because the screen of the Digital Photo Frame is made of glass and it would easily be broken or scratched.
- If fingerprints or dust accumulate on the LCD screen, we recommend using a soft, non-abrasive cloth such as a camera lens cloth to clean the LCD screen.
- Moisten the cleaning cloth with the cleaning solution and apply the cloth to the screen.

#### **WARNING:**

Please power off the unit before inserting or removing a card or USB device.

Failure to do so may cause damage to the card/USB and the unit.

To reduce the risk of fire or electric shock, do not expose this appliance to rain or moisture.

This device is designed for private use only!

## Introduction:

Thank you for your purchase of the Digital Photo Frame. It is designed to allow quick and easy view of photos taken from your digital camera, mobile phone, or from a memory storage card. Please read this User Manual carefully to learn the correct way to use the Digital Photo Frame.

## Features:

1. Support picture format: JPEG ,BMP,PNG
2. Support audio format: MP3,WMA,WMV
3. Support video format:  
rm,rmvb,Avi,Divx,MP4,3GP,MOV,MKV,MPEG, DivX4/5/6,Xvid,WMV,H.264  
(Support (720P,1080i,1080P))
4. Support memory card: SD/SDHC/MMC
5. USB connection: USB 2.0
6. Built in 8GB SD card as internal memory
7. HDMI interface: Support HDMI-IN function
8. Slideshow with background music
9. Support Scroll Subtitle when playing photo ,Music ,Movie
10. Built-in clock, schedule auto on/off.
11. Support copy files from USB to SD card
12. Adjustable brightness, contrast, saturation
13. OSD languages: German, English and other languages selectable

## Packaging Check List:

- |                                |         |
|--------------------------------|---------|
| 1. 15 inch digital photo frame | 1 piece |
| 2. AC/DC adapter               | 1 piece |
| 3. Remote control              | 1 piece |
| 4. User manual                 | 1 piece |
| 5. Stand                       | 1 piece |

# CONTENTS

1 Product Diagram .....	5
1.1 Remote Control .....	5
1.2 Rear and Left Side of Frame .....	6
2. Installing & Replacing the Battery .....	7
3. Getting Started .....	7
4. Operating Instruction.....	7
4.1 Main Menu .....	7
4.2 Picture Mode/Delete Function .....	8
4.3 Music Mode/Delete Function.....	9
4.4 Video Mode /Delete Function .....	10
5. Scroll Subtitle function .....	11
6. Calendar .....	12
7. HDMI-IN Function .....	12
8. Setup Menu .....	13
9. Stand Instruction .....	13
10. Technical Specifications .....	14
11. Troubleshooting Guide .....	14

# 1 Product Diagram

## 1.1 Remote Control

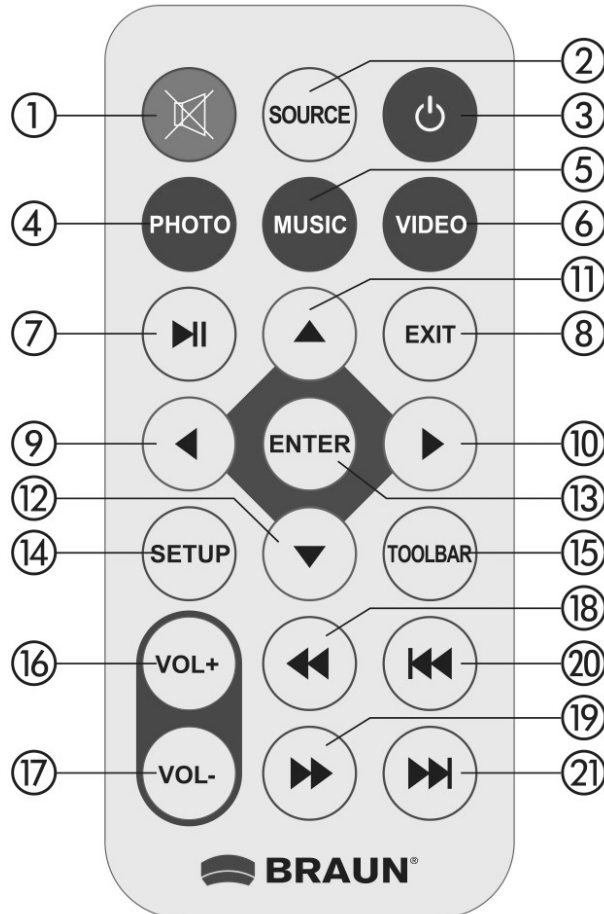

- 1) **Mute**— Silence the voice temporarily
- 2) **SOURCE**— Press it to choose the input Source ( HDMI-IN /DMP)
- 3) **POWER** — Switch On/Off.
- 4) **Photo** —Press directly to play Photo
- 5) **Music** —Press directly to play Music
- 6) **Movie**— Press directly to play Movie
- 7) **▶||** — **Play/pause**: Press directly to begin playback under stop or pause status, and repress it, it will pause again.
- 8) **Exit**— Return to upper page
- 9) **◀** — Functional selection button from right to left cursor
- 10) **▶**— Functional selection button from left to right cursor
- 11) **▲**— Functional selection button from down t to up cursor
- 12) **▼**— Functional selection button from up to down cursor

- 13) **Enter**— Press to confirm
- 14) **Setup**— Go directly to Setup mode.
- 15) **Toolbar**— Go directly to info bar or delete Photo, Music ,Video
- 16) **VOL +** —Turn up the volume
- 17) **VOL-** — Turn down the volume.
- 18) **◀◀**— Back Forward when playing Music or video file
- 19) **▶▶**—Fast Forward when playing Music or video file
- 20) **◀◀** — Move back to previous music or video file
- 21) **▶▶** — Move forward to next music or video file

## 1.2 Rear and Left Side of Frame

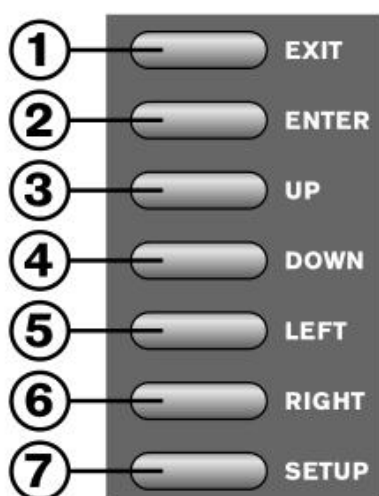

- 1. EXIT
- 2. ENTER
- 3. UP
- 4. DOWN
- 5. LEFT
- 6. RIGHT
- 7. SETUP

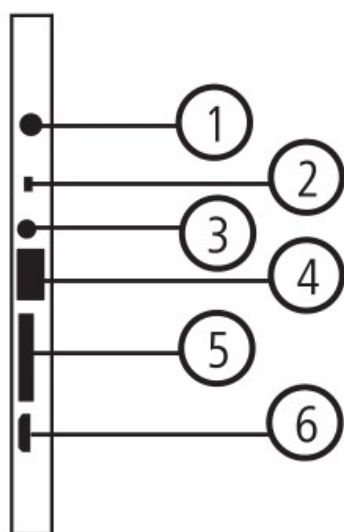

- 1.DC IN
- 2.ON/OFF
- 3.Earphone Jack
- 4.USB
- 5.SD/SDHC/MMC
- 6.HDMI IN

## 2. Installing & Replacing the Battery

Place the upside of the remote control down, press down on the ridged area of the battery cover and pull towards you to remove the tray. Place one CR2025 lithium button-cell battery on the tray with the positive “+” side facing you. Reinsert the tray.



## 3. Getting Started

3.1 Plug one end of the included AC adapter into a standard 80-240V AC electrical outlet and the other end into the DC in of the frame.

3.2. Remove the protective film covering the LCD.

3.3. Remove the plastic battery insulator from the battery compartment and make sure the remote control has a battery inside. Please refer to “Installing & Replacing Battery” if you need a new battery.

## 4. Operating Instruction



After turning the Units, it will show the start-up logo, and then slideshow will be played automatically from the built –in memory .

### 4.1 Main Menu

It supports SD/ SDHC/ MMC and USB 2.0 . then press **EXIT** twice to access to photo, music, video, calendar and Setup choose interface. Press **ENTER** to confirm the item you want.

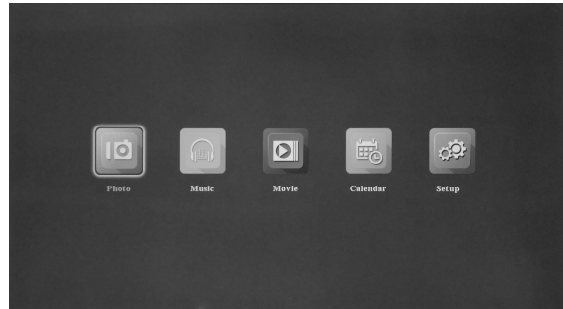
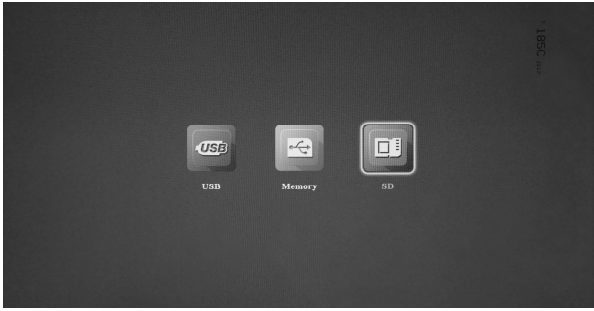

**Note:** 1) Make sure there are supported picture, music and video files in the Card or USB device.

2) you can also select Photo, Music, Photo+ Music ,Movie ,Phot to Movie ,off in the **Setup** Menu

## 4.2 Picture Mode/Delete Function

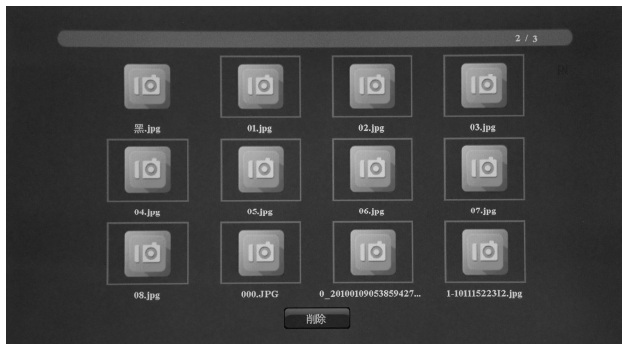

Highlight **Photo** from the main menu, Press **ENTER** to Select USB 2.0 or memory card you want to play , then press **ENTER** again to access to thumbnail mode, press **▲▼◀▶** to select the picture you want to play and press **ENTER** to confirm

### Delete function:

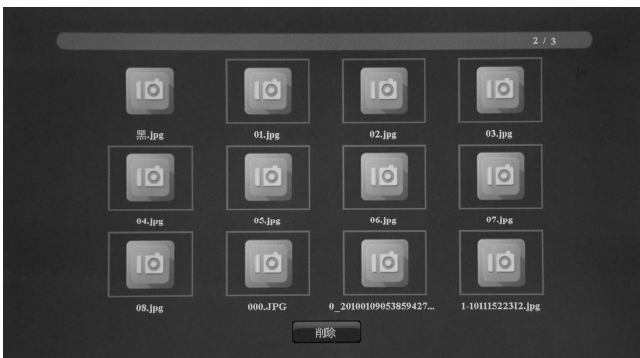

In thumbnail mode , Use **▲▼◀▶** to select the picture you want to delete , press **TOOLBAR** to enter into Delete interface and then press **ENTER** to select "YES " to confirm





When the single picture is playing, press **TOOLBAR** to enter information Bar, and select following items by **◀▶**: **Play/Pause, Prev, Next, Stop, All/Random/Off/One ,Music, Playlist, Info, Rotate, Zoom In , Zoom Out** than press **ENTER** to confirm.

### 4.3 Music Mode/Delete Function

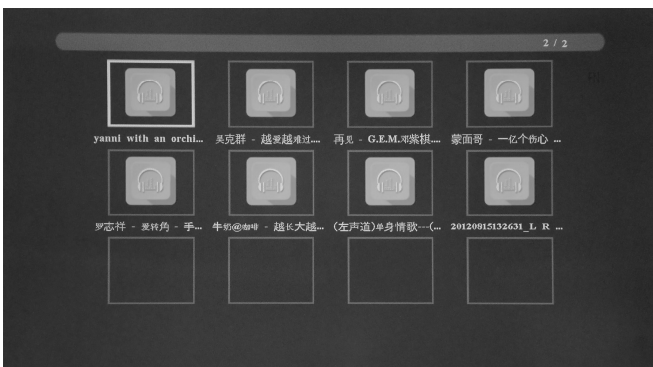

Highlight **Music** from the main menu, Press **ENTER** to Select USB 2.0 or memory card you want to play, then press **ENTER** again to access to thumbnail mode, press **▲▼◀▶** to select the music you want to play and press **ENTER** to confirm

#### Delete Function :

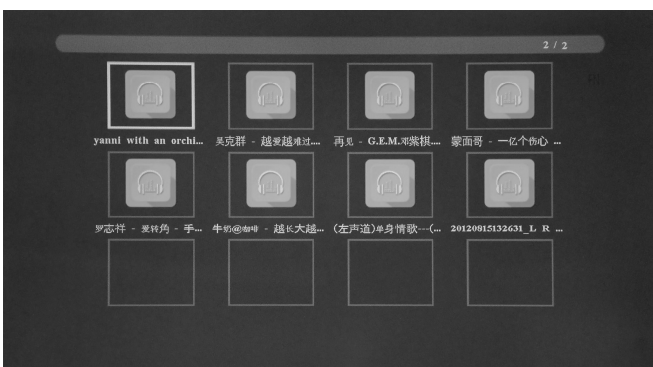

In thumbnail mode , Use **▲▼◀▶** to select the Music you want to delete, press **TOOLBAR** to enter into Delete interface and then press **ENTER** to select **“YES”** to confirm

## Music Play



When the music is playing , press **TOOLBAR** to enter music information bar and select following itmes by ◀ ▶: Pause/Play, FB, FF, Prev, Next, Stop, All/Random/Off/One ,Set A/SETB/NONE(Press **Enter** to shift) ,, Mute, Playlist, Info, Goto Time, then press **ENTER** to operate.

## 4.4 Video Mode /Delete Function

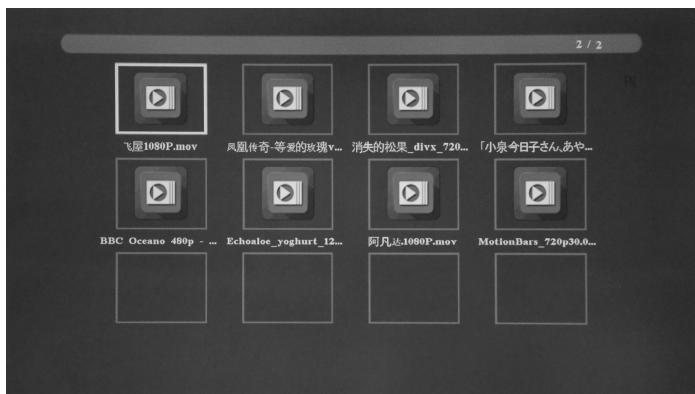

Highlight **Video** from the main menu, Press **ENTER** to Select the RAID, USB 2.0 or memory card you want to play , then press **ENTER** again to access to thumbnail mode, press ▲▼◀▶ to select the video you want to play and press **ENTER** to confirm

### Delete Function:



In thumbnail mode , Use ▲▼◀▶ to select the Video you want to delete, press **TOOLBAR** to enter into Delete interface and then press to confirm

## Video Play



When the video is playing, press **TOOLBAR** to enter video, and select following items by ◀▶: Pause/Play, FB, FF, Prev, Next, Stop, All/Random/Off/One, SET A/SETB/NONE((Press **Enter** to shift)), Playlist, Info, SlowF, StepF, Goto Time (press **ENTER** to set goto time), Zoom in, Zoom out and then press **ENTER** to confirm.

## 4.5 Auto Copy function for picture/music/video files

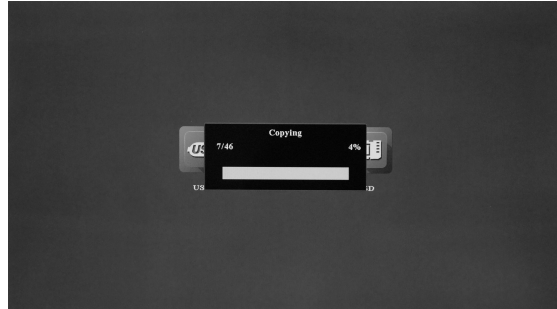
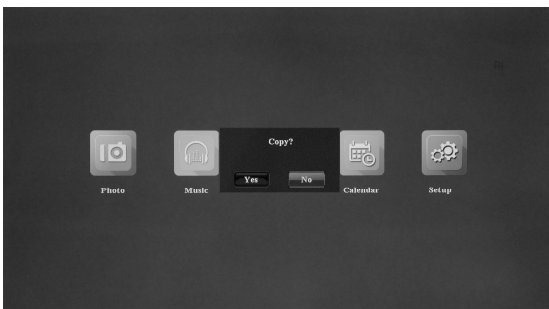

Create a txt file named “copy” and put this txt file in the USB disk (**copy.txt**). It supports copy all the files from USB device to internal memory. Use ◀ ▶ to select “Copy” - “Yes” or “ No”, press **ENTER** to confirm. It will show a progress bar. After copy successfully, the DPF will auto start the media.

Remark: Make sure the photo/music/videos files existed in the sub menu of **USB**, not under any folder of **USB**. Or the copy function will be failed.

## 5. Scroll Subtitle function

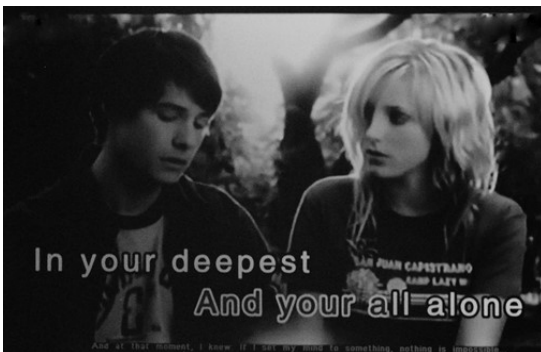

It support Scroll Subtitle function when playing photo, music and video. The setting steps of Scroll Subtitle as following

- a) Create a TXT file

b) Then Save as the TXT file with the code format “Unicode” and named “SCROLL.TXT”

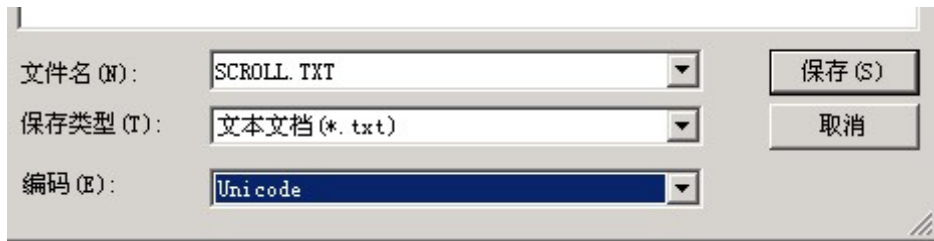

c) Copy this TXT file to USB disk or Memory card you want

d) Insert the USB disk or Memory card , it will show the Subtitle when playing Photo or Music or videos

**Remark:** 1.Make sure there are some pictures/music/videos existed in USB/SD, not under any folder of USB/SD. Or the scrolling function will be failed.

2. If you want to display new subtitle , please unplug the adapter to power off to clear the memory ,otherwise the DPF still display the previous scroll subtitle .

## 6. Calendar



Enter into **Calendar** from the main menu, Browse the calendar by ▲▼◀▶.

## 7. HDMI-IN Function

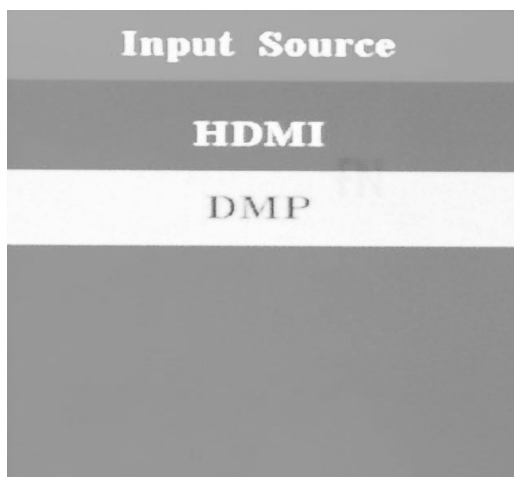

Connect the HDMI-out device with the HDMI-IN interface of the frames .Press **SOURCE** to choose **HDMI** to select input Source “HDMI”

## 8. Setup Menu

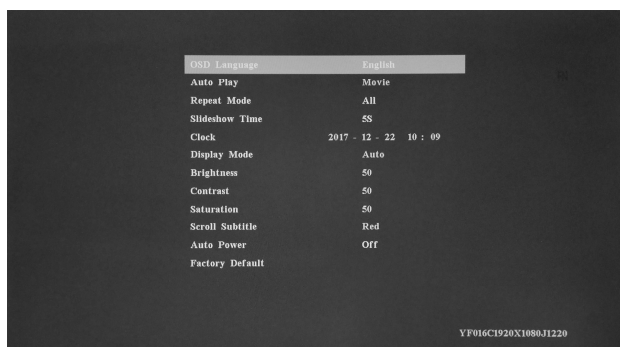

Highlight **Setup** in the main Menu, press **ENTER** to access, press ▲▼ to select the item you want ,Press◀▶ to select the sub-item you want to setup

- 8.1 Language: German, English and other languages selectable
- 8.2 Auto Play: Photo ,Music ,Photo+Music ,Movie, Off
- 8.3 Repeat Mode : All, Random, one ,off
- 8.4 Slideshow Mode: Off, Random, Blocks, Diagonal Blocks, Wipe, Slide, Fade
- 8.5 Slideshow Time : 3S/5S/10S/30S/60S
- 8.6 Clock: Press **ENTER** to enter, and then press▲▼◀▶ to adjust the time you want to set: Date, Month, Year, Hour, Minute, Sec
- 8.7 Display Mode : Auto, Fit, Panorama
- 8.8 Brightness : Use ◀▶ to select from 0 (lowest) to 100 (highest)
- 8.9 Contrast: Use ◀▶ to select from 0 (lowest) to 100 (highest)
- 8.10 Saturation: Use ◀▶ to select from 0 (lowest) to 100 (highest)
- 8.11 Scroll Subtitle: Black ,White ,Red, Blue, Green , Off
- 8.12 Auto Power: Press **ENTER**, then use ▲▼◀▶ to choose off /on, When select "on" ,then you can setup Hour ,Min, you want to Auto power on/off
- 8.13 Factory Default: Press **ENTER** to confirm.

## 9. Stand Instruction

Screw the post into the slot of the digital photo frame, rotate the post clockwise until

tight. Please refer to the illustration shown below.

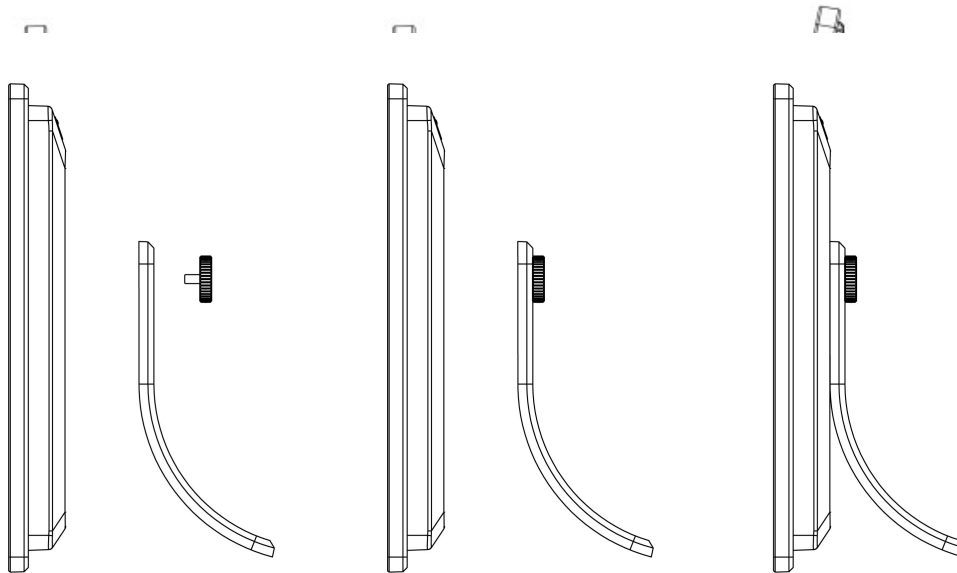

## 10. Technical Specifications

- **Adapter:** Input: AC 80-240V 50/60HZ Output: DC 12V /1.5A
- **Picture Formats:** JPEG ,BMP,PNG
- **Audio Formats:** MP3,WMA,WMV
- **Video Formats:**  
rm,rmvb,Avi,Divx,MP4,3GP,MOV,MKV,MPEG,DivX4/5/6,Xvid,WMV,H.264  
(Support (720P,1080i,1080P))
- **Screen Parameter:**  
Screen Size: 15 inch  
Resolution: 1024\* 768 Pixel  
Aspect Ratio: 16:9  
Brightness:about 350cd/m2  
Contrast:700:1  
Response Time: 20ms  
Viewing Angle: 89°(left/right/vertical), 89°(horizontal)  
Working Temperature: 0~40, Humidity: 10-85%

## 11. Troubleshooting Guide

If you are having problems with your player, please consult both this guide and manual.If you need further assistance, please contact Technical Support.

- **No power:**  
Please check whether the plug is inserted correctly.
- **Remote control no function:**  
Please check whether the battery has power (the battery can be used for half a year in normal conditions). Replace with new battery if necessary.
- **Can not read the CARD or USB:**  
Please confirm whether there is storage in the card or USB device.  
Empty devices cannot be read.
- **Can not play the file:**  
Please confirm if the file format is compatible with the player.
- **Display too bright or too dark:**  
Please adjust the brightness or contrast in the setup menu.
- **The color is light or no color:**  
Please adjust the color and contrast setup.
- **No sound:**  
Please check whether the volume is correct and the player is not in Mute mode.

### **Technical support**

We strive to provide the best customer service. If you need help with your BRAUN product, contact BRAUN Technical Support before returning the device. You can reach us in one of the following ways:

Email: [post@braun-phototechnik.de](mailto:post@braun-phototechnik.de)

Web: [www.braun-phototechnik.de](http://www.braun-phototechnik.de)

+49 (0) 7457 / 9465-60

### **Declaration on CE regulations**

This device has been tested and complies with the requirements for a digital device in accordance with CE regulations. These limits are intended to provide adequate protection against detrimental disturbances in domestic installations.

BRAUN PHOTO TECHNIK GmbH

Merkurstrasse 8

72184 Eutingen / Germany

Phone: +49 (0) 7457 / 9465-60