

# OTP16...125

## Installation instruction

1

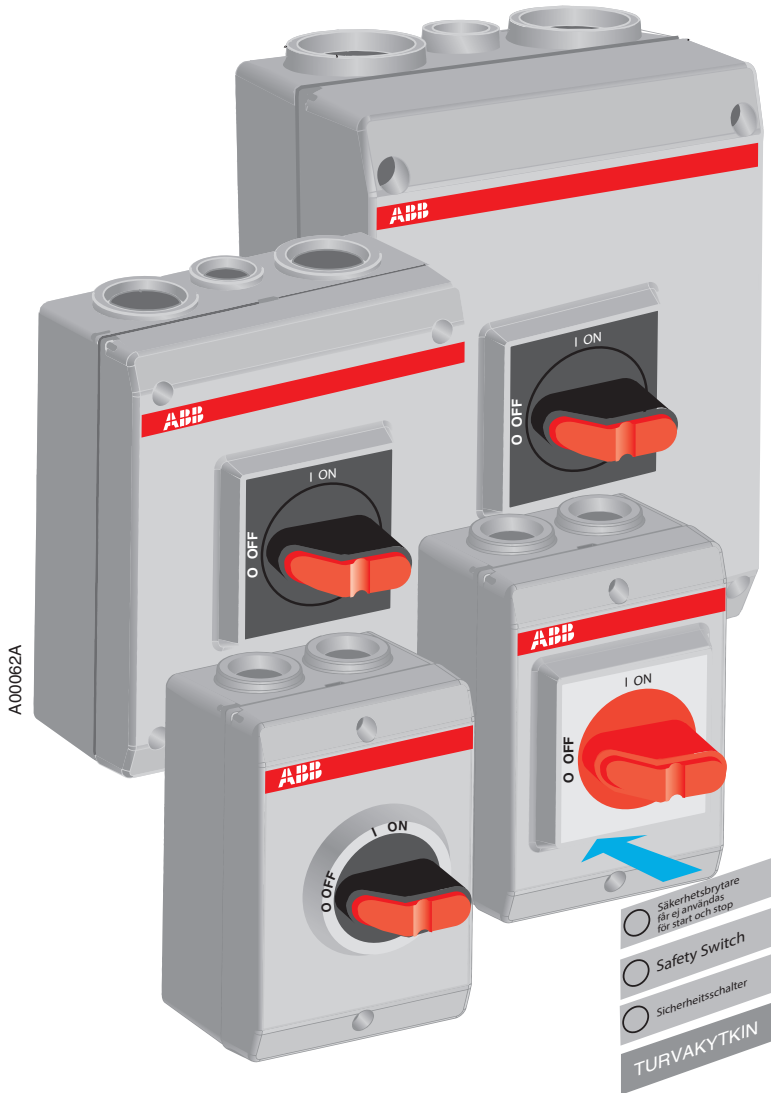

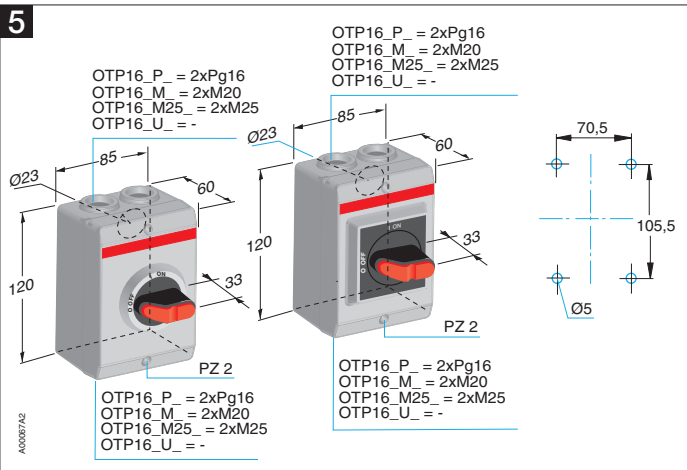
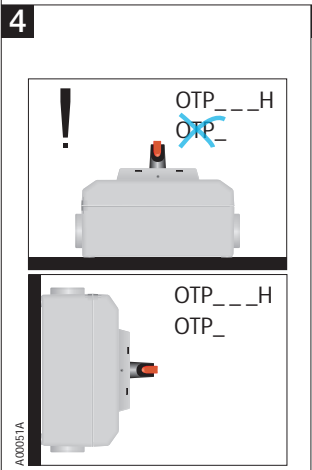
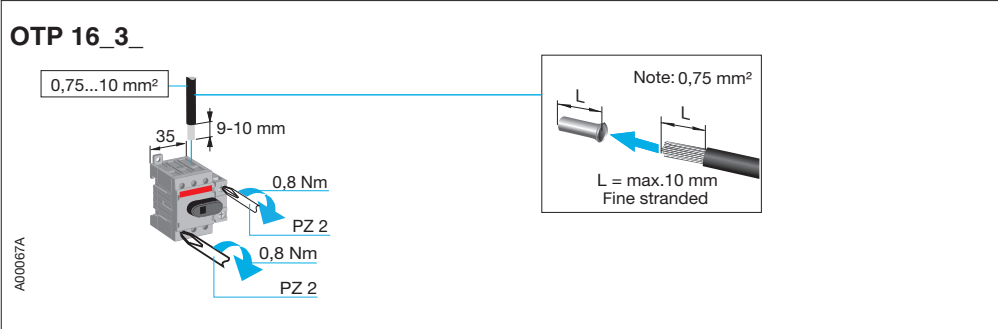
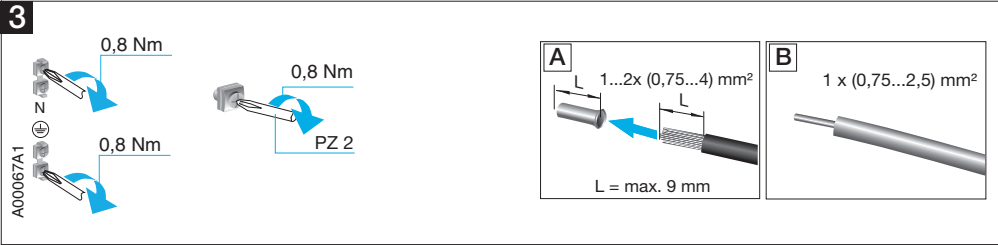
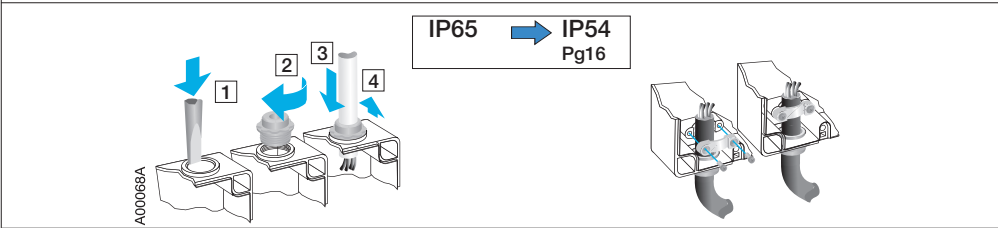
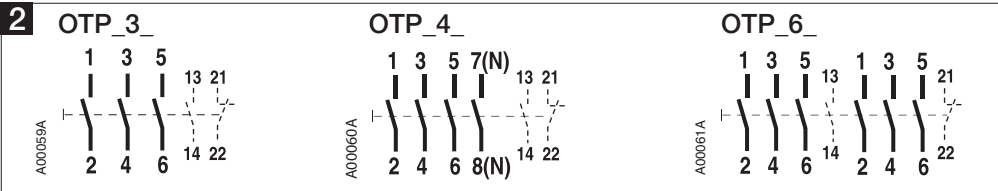

6

OTP 16\_  
OTP 25\_  
OTP 32\_

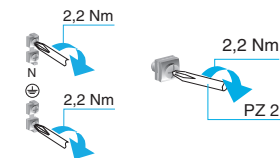

A00066A

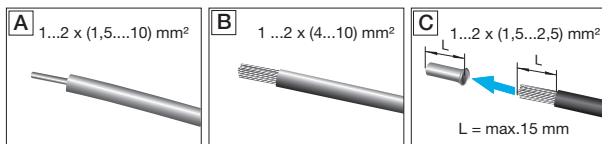

OTP 16\_3\_, OTP 16\_4\_  
OTP 25\_3\_, OTP 25\_4\_  
OTP 32\_3\_, OTP 32\_4\_

OTP 16\_6\_  
OTP 25\_6\_  
OTP 32\_6\_

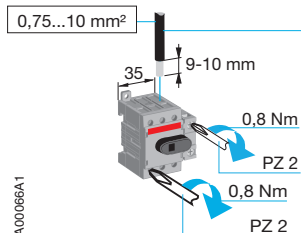

A00066A1

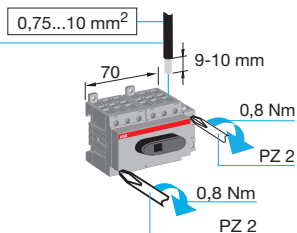
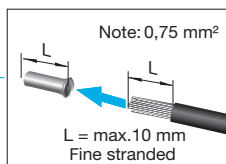

7

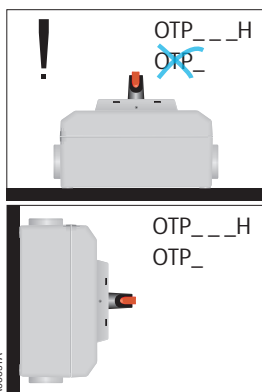

A00051A

8

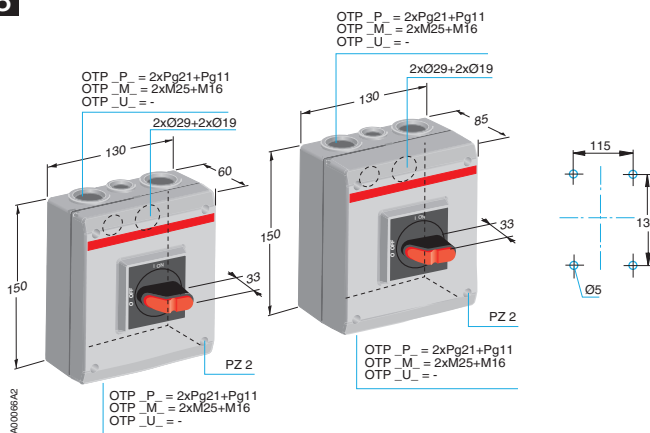

A000642

9

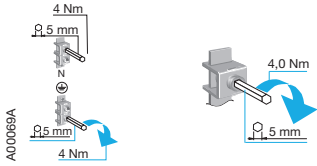

A00069A

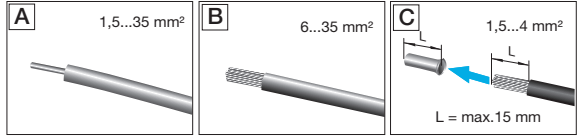

OTP 25\_3\_, OTP 25\_4\_  
OTP 36\_3\_, OTP 36\_4\_  
OTP 45\_3\_, OTP 45\_4\_  
OTP 63\_3\_, OTP 63\_4\_

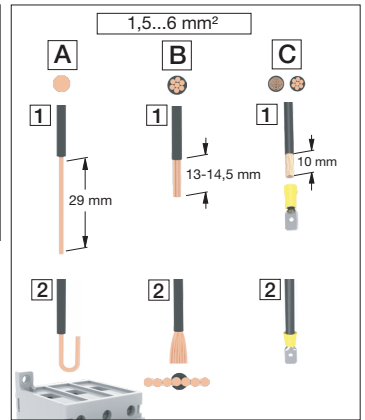
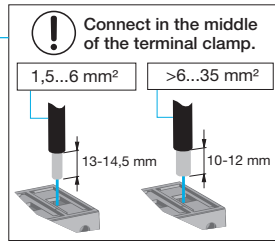
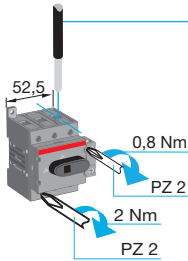

A0069A1

10

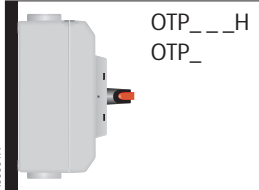
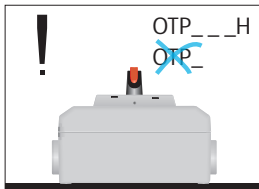

A00051A

11

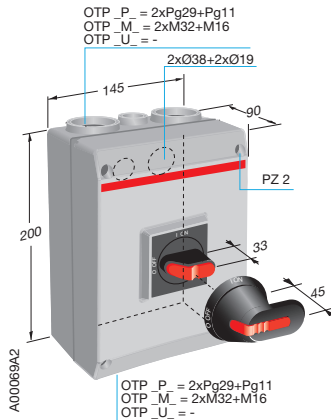

A00069A2

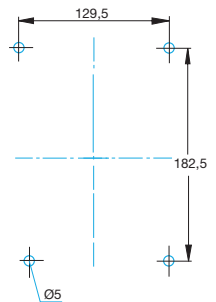

12

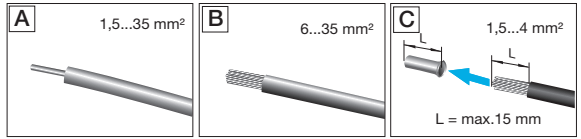
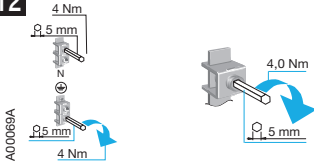

OTP 25\_6\_  
OTP 36\_6\_  
OTP 45\_6\_  
OTP 63\_6\_

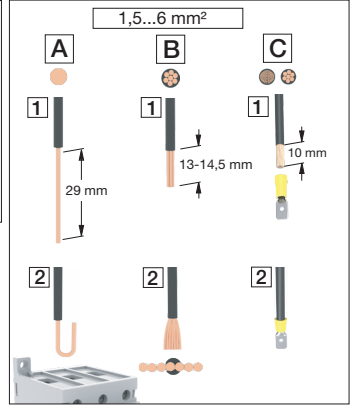
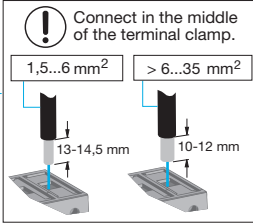
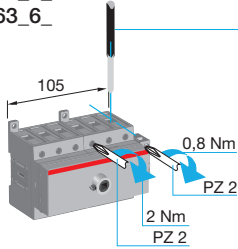

OTP 63T\_  
OTP 63A\_

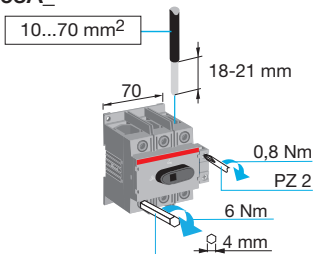

13

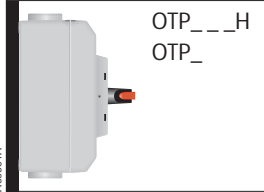
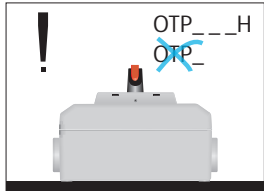

14

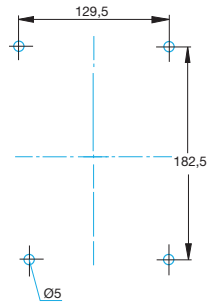
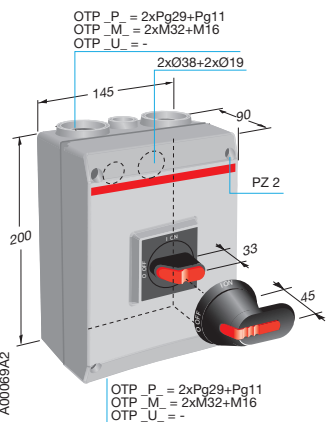



18

Ø5...8 mm

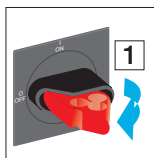
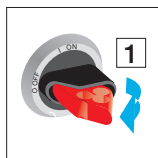

19

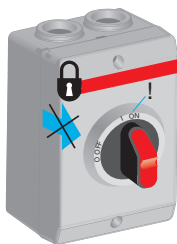

20

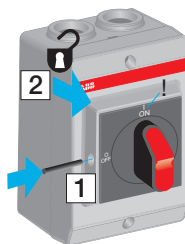
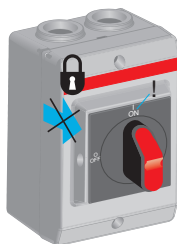

22

Ø5...10 mm

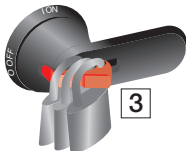
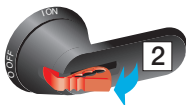
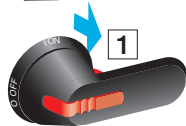

21

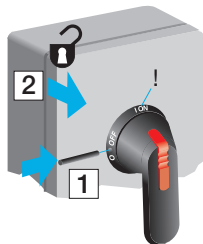
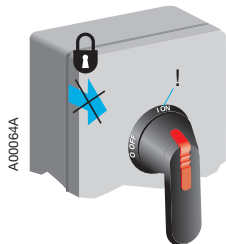

23

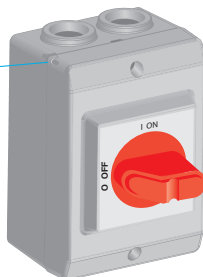
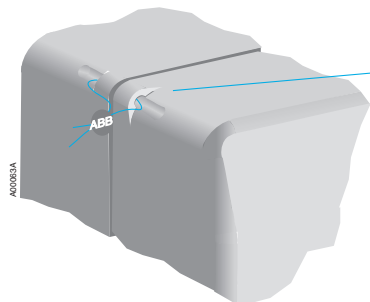



<b>BG</b>	Внимание! Опасно напряжение! Да се монтира само от лице с електротехническа квалификация.
<b>FR</b>	Avertissement! Tension électrique dangereuse! Installation uniquement par des personnes qualifiées en électrotechnique.
<b>MT</b>	Twissija! Vultagġ perikoluż! Ghandu jiġi installat biss minn persuna b'kompetenza elettroteknika.
<b>HR</b>	Upozorenje! Opasan napon! Postavljati smije samo elektrotehnički stručnjak.
<b>DE</b>	Warnung! Gefährliche Spannung! Installation nur durch elektrotechnische Fachkraft.
<b>PL</b>	Ostrzeżenie! Niebezpieczne napięcie! Instalacji może dokonać wyłącznie osoba z fachową wiedzą w dziedzinie elektrotechniki.
<b>CS</b>	Varování! Nebezpečné napětí! Montáž smí provádět výhradně elektrotechnik!
<b>EL</b>	Προειδοποίηση! Υψηλή τάση! Η εγκατάσταση πρέπει να γίνεται μόνο από εξειδικευμένους ηλεκτροτεχνικούς.
<b>PT</b>	Aviso! Tensão perigosa! A instalação só deve ser realizada por um electricista especializado.
<b>DA</b>	Advarsel! Farlig elektrisk spænding! Installation må kun foretages af personer med elektroteknisk ekspertise.
<b>HU</b>	Figyelmeztetés! Veszélyes feszültség! Csak elektrotechnikai tapasztalattal rendelkező szakember helyezheti üzembe.
<b>RO</b>	Avertizare! Tensiune periculoasă! Instalarea trebuie efectuată numai de către o persoană cu experiență în electrotehnică.
<b>NL</b>	Waarschuwing! Gevaarlijke spanning! Mag alleen geïnstalleerd worden door een deskundige elektrotechnicus.
<b>IE</b>	Rabhadh! Voltas guaiseach! Ba chóir do dhuine ag a bhfuil saineolas leitríteicniúil, agus an té sin amháin, é seo a shuiteáil.
<b>SK</b>	Varovanie! Nebezpečné napätie! Montáž môže vykonávať iba skúsený elektrotechnik.
<b>EN</b>	Warning! Hazardous voltage! Installation by person with electrotechnical expertise only.
<b>IT</b>	Avvertenza! Tensione pericolosa! Fare installare solo da un elettricista qualificato.
<b>SL</b>	Opozorilo! Nevarna napetost! Vgradnjo lahko opravi le oseba z elektrotehničnim strokovnim znanjem.
<b>ET</b>	Hoiatus! Ohtlik pinge. Paigaldada võib ainult elektrotehnikalaalne ekspert.
<b>LV</b>	Uzmanību! Bīstami - elektrība! Montāžas darbus drīkst veikt tikai personas, kurām ir atbilstošas elektrotehniskās zināšanas.
<b>ES</b>	¡Advertencia! ¡Tensión peligrosa! La instalación deberá ser realizada únicamente por electricistas especializados.
<b>FI</b>	Varoitus! Vaarallinen jännite! Asennuksen voi tehdä vain sähköalan ammattihenkilö.
<b>LT</b>	Dėmesio! Pavojinga įtampa! Dirbti leidžiama tik elektrotechniko patirties turintiems asmenims.
<b>SE</b>	Varning! Farlig spänning! Installation får endast utföras av en elektriker.
<b>CN</b>	警告！电压危险！只能由专业电工进行安装。
<b>RU</b>	Осторожно! Опасное напряжение! Монтаж должен выполняться только специалистом-электриком.

For more information please contact:

ABB Oy, Protection and Connection  
P.O. Box 622, FI-65101 Vaasa, Finland  
[www.abb.com/lowvoltage](http://www.abb.com/lowvoltage)

Power and productivity  
for a better world™

