



Quick Start Guide

Cruiser 4MP

EN

VN

TH

BM

ID

JP

KR

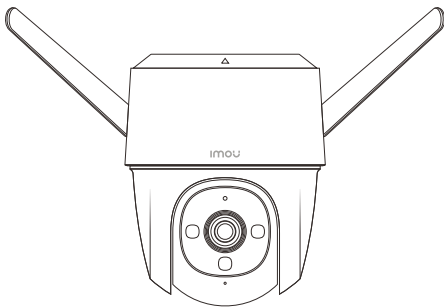

Welcome

Thank you for choosing IMOU.

We are devoted to providing you easy smart home products. If you have problems using the product, please contact our service team before returning your product.

Our service mail: service.global@imoulife.com

Frequently asked questions can be found at imoulife.com/support/help



Package content

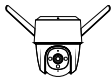

Camera x1



Quick Start Guide x1



Power Adapter x1



Screw Package x1

Mounting
Template x1

Mounting Bracket x1

Waterproof
Connector x1

Camera introduction

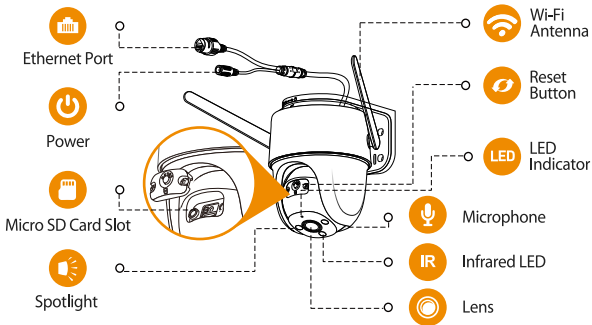

Note: Disconnect the camera from the power before installation or taking out its SD card.

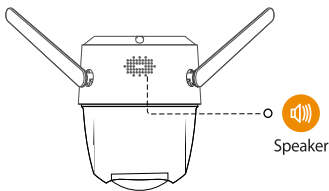

- Note:**
1. Press and hold the reset button for 10 s to reset the camera.
 2. Double-press the reset button to enable camera's hotspot.

See the table below for definitions of camera's LED behaviors.

LED Indicator Status	Device Status
off	<ul style="list-style-type: none"> ● Power off/LED turned off ● Rebooting after reset
Solid red	<ul style="list-style-type: none"> ● Booting ● Device malfunction
Flashing red	<ul style="list-style-type: none"> ● Network connection failed ● Pairing failed
Flashing green	<ul style="list-style-type: none"> ● Ready for network configuration ● Ready to pair
Solid green	<ul style="list-style-type: none"> ● Operating properly
Flashing green and red alternately	<ul style="list-style-type: none"> ● Updating firmware

1 Download the APP

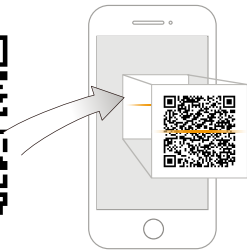

Imou Life



Download on the
App Store



GET IT ON
Google play



Windows

i Tips

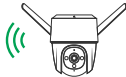
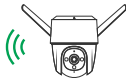

To ensure the best possible wireless performance, please make sure there are no obstacles and electromagnetic interference between the camera and router.

2 Add device to the APP

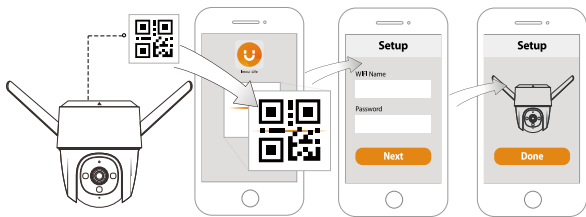



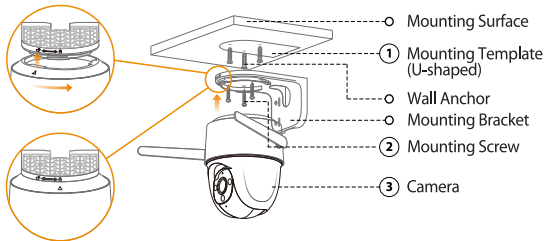

3 Installing Camera

Note: Make sure that the mounting surface is strong enough to hold at least three times the weight of the camera and the bracket.



Ceiling Mount

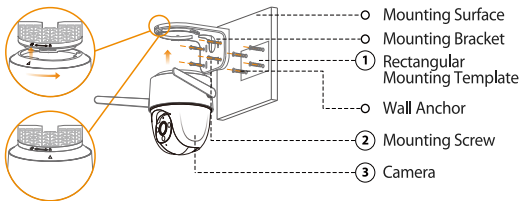

- 1 Peel off the U-shaped mounting template and stick it to the desired installation area.
- 2 Drill holes into the mounting surface as the mounting template marks and then insert wall anchors as needed.
- 3 Secure the mounting bracket to the surface with included mounting screws.
- 4 Align  on the top of the camera with  on the bracket, then fit the two parts together.
- 5 Rotate the camera counterclockwise until it is locked. Make sure  align with .
- 6 Power on the camera and then adjust its angle properly.

Wall Mount





- 1 Peel off the rectangular mounting template and stick it to the desired installation area.
- 2 Drill holes into the mounting surface as the mounting template marks and then insert wall anchors as needed.
- 3 Secure the mounting bracket to the surface with included mounting screws.
- 4 Align  on the top of the camera with  on the bracket, then fit the two parts together.

- ⑤ Rotate the camera counterclockwise until it is locked. Make sure \triangle align with .
- ⑥ Power on the camera and then adjust its angle properly.

Pole Mount

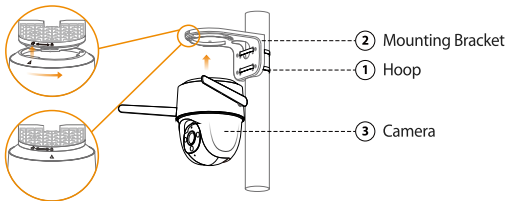
-  **Note:** 1. Make sure that the pole is strong enough to hold at least three times the weight of the camera and the bracket.
2. The hoops are not provided. Please prepare them in advance.



- ① Thread the hoop through the mounting holes on the bracket, then attach the bracket to the pole.
- ② Align \triangle on the top of the camera with  on the bracket, then fit the two parts together.
- ③ Rotate the camera counterclockwise until it is locked. Make sure \triangle align with .
- ④ Power on the camera and then adjust its angle properly.



DC
12V1A

Question	Answer
The device cannot boot up or work as expected?	<ul style="list-style-type: none"> • Check the LED indicator status. If the light is not in green, press and hold the reset button for 10 s to reset the camera.
How to connect the camera to another Wi-Fi network?	<ul style="list-style-type: none"> • If the camera is online, select Device Details > Network Config to change the Wi-Fi connection on the app. • If the camera is offline, reset the camera, and then configure the camera again.
Connection takes too long?	<ul style="list-style-type: none"> • Check if the distance between the camera and the router, and that between the camera and the smart phone is both within 5 m (16.4 ft) during the connection. • Check the Wi-Fi configuration of the router: Select the channel to auto, and the mode to 11bgn mixed.
When the micro SD card is full, how is the recorded video saved?	<ul style="list-style-type: none"> • When the micro SD card is full, the system will overwrite the previous recorded videos. Save the important information in time.
Where are the recorded videos saved?	<ul style="list-style-type: none"> • If you have activated the cloud storage and installed a micro SD card, the recordings will be both saved to the card and cloud. If the cloud storage is deactivated, the recordings are saved to the SD card. Videos recorded during live view or playback is saved on your phone.
The device is offline?	<p>Check the indicator status:</p> <ul style="list-style-type: none"> • Solid green: Check whether the router can connect to the Internet. If the network is connected, restart the camera. • Flashing red: Reset the camera, and then configure the camera again. • Solid red: The camera is faulty.

Hướng Dẫn Sử Dụng

Cruiser 4MP

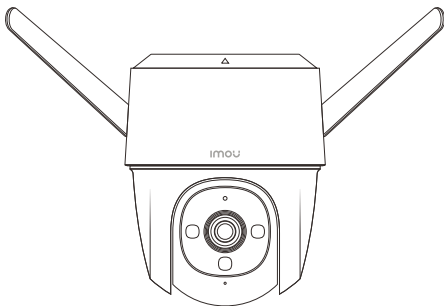

Chào Mừng

Cảm ơn bạn đã lựa chọn IMOU

Chúng tôi đang cố gắng để cung cấp tới bạn những sản phẩm nhà thông minh dễ dàng kết nối và sử dụng nhất.

Nếu trong quá trình sử dụng sản phẩm bạn gặp phải vấn đề, vui lòng liên hệ bộ phận Kỹ thuật để được hỗ trợ.

Thư điện tử của chúng tôi: service.global@imoulife.com

Tìm kiếm các Câu Hỏi Thường Gặp tại:
imoulife.com/support/help



Sản Phẩm

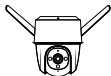

Camera x1



HDSD x1



Adapter x1



Gối Vít x1



Tấm Định Vị x1



Chân Đế x1



Đầu Nối Chống Nước x1

Giới Thiệu Về Camera

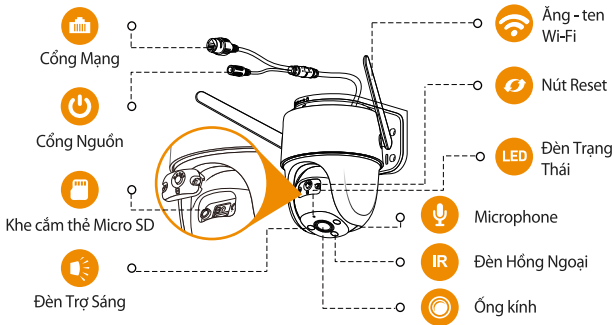

Ghi chú: Ngắt nguồn điện của camera trước khi lắp đặt hoặc tháo, lắp thẻ nhớ.

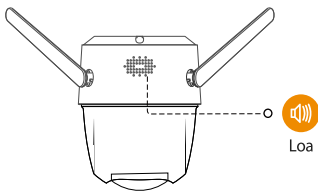

- Ghi chú:**
1. Nhấn và giữ nút Reset 10s để đưa camera về mặc định.
 2. Nhấn liên tiếp nút reset 2 lần để kích hoạt chế độ Wi-Fi Hotspot.

Xem bảng bên dưới để biết được ý nghĩa của Đèn Trạng Thái.

Trạng Thái Đèn LED	Trạng Thái Thiết Bị
Tắt	<ul style="list-style-type: none"> ● Không có nguồn/Đèn LED tắt ● Khởi động lại sau khi mặc định
Màu Đỏ	<ul style="list-style-type: none"> ● Đang khởi động ● Thiết bị gặp sự cố
Nháy Đỏ	<ul style="list-style-type: none"> ● Kết nối thất bại ● Ghép nối thất bại
Nháy Xanh	<ul style="list-style-type: none"> ● Đang chờ kết nối mạng ● Sẵn sàng ghép nối
Màu Xanh	<ul style="list-style-type: none"> ● Đang hoạt động
Nháy xanh và nháy đỏ xen kẽ	<ul style="list-style-type: none"> ● Đang cập nhật phần mềm

1 Tài ứng dụng

VN

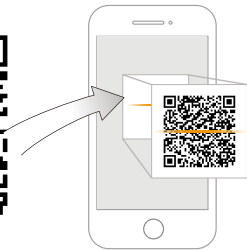

i Tips

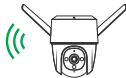
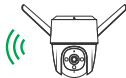

Để kết nối được ổn định, hãy đảm bảo khoảng cách kết nối từ camera đến Router không có vật cản.

2 Thêm thiết bị vào ứng dụng

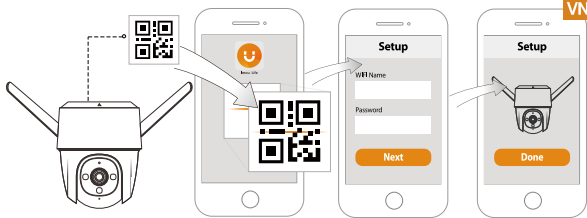



3 Cài Đặt Camera

Ghi chú: Hãy đảm bảo rằng cột đủ chắc chắn để giữ ít nhất ba lần trọng lượng của camera và chân đế.

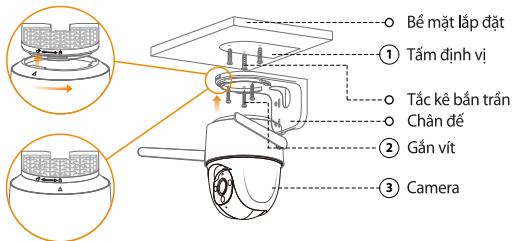
Gắn Trần



- ① Bóc tấm định vị hình chữ U và đặt vào vị trí mong muốn lắp đặt camera.
- ② Khoan lỗ vào bề mặt lắp đặt theo Tấm Định Vị và đặt các vít nở vào đó.
- ③ Cố định chân đế bằng vít đi kèm.
- ④ Căn chỉnh biểu tượng \triangle trên đỉnh của camera trùng với biểu tượng  của chân đế. Sau đó cố định hai phần với nhau.
- ⑤ Xoay camera ngược chiều kim đồng hồ cho đến khi được khoá cố định. Hãy đảm bảo biểu tượng \triangle trùng khớp với biểu tượng .
- ⑥ Cấp nguồn cho camera và điều chỉnh góc quan sát lý tưởng.

Gắn Tường

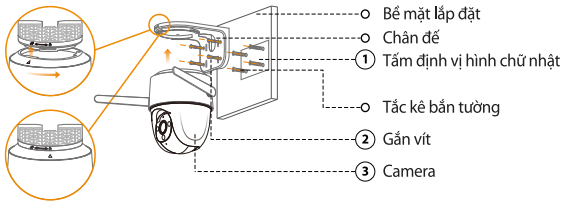

- ① Bóc tấm định vị và đặt vào vị trí mong muốn lắp đặt camera.
- ② Khoan lỗ vào bề mặt lắp đặt theo Tấm Định Vị và đặt các vít nở vào đó.
- ③ Cố định chân đế bằng vít đi kèm.
- ④ Căn chỉnh biểu tượng \triangle trên đỉnh của camera trùng với biểu tượng  của chân đế. Sau đó cố định hai phần với nhau.

- ⑤ Xoay camera ngược chiều kim đồng hồ cho đến khi được khoá cố định. Hãy đảm bảo biểu tượng \triangle trùng khớp với biểu tượng \mathcal{A} .
- ⑥ Cấp nguồn cho camera và điều chỉnh góc quan sát lý tưởng.

Gắn Cột

- Ghi chú:** 1. Hãy đảm bảo rằng cột đủ chắc chắn để giữ ít nhất ba lần trọng lượng của camera và chân đế.
2. Đai không được đi kèm trong hộp sản phẩm. Vui lòng chuẩn bị trước.

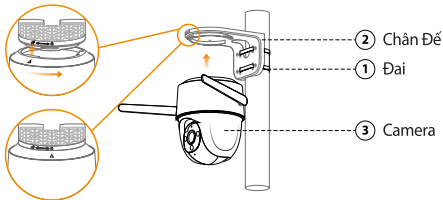

- ① Luồn dây đai qua các lỗ trên chân đế. Sau đó siết chặt để cố định chân đế vào cột.
- ② Căn chỉnh biểu tượng \triangle trên đỉnh của camera trùng với biểu tượng \mathcal{A} của chân đế. Sau đó cố định hai phần với nhau.
- ③ Xoay camera ngược chiều kim đồng hồ cho đến khi được khoá cố định. Hãy đảm bảo biểu tượng \triangle trùng khớp với biểu tượng \mathcal{A} .
- ④ Cấp nguồn cho camera và điều chỉnh góc quan sát lý tưởng.



DC
12V1A

Câu Hỏi	Câu Trả Lời
Camera không thể khởi động hoặc hoạt động không ổn định ?	<ul style="list-style-type: none"> • Kiểm tra đèn trạng thái của camera. Nếu không phải màu xanh, ấn và giữ nút Reset 10 giây để mặc định camera.
Làm thế nào để kết nối camera đến mạng Wi-Fi khác ?	<ul style="list-style-type: none"> • Nếu camera trực tuyến, chọn Chi Tiết Thiết Bị > Mạng Lưới để thay đổi kết nối Wi-Fi. • Nếu camera trực tuyến, chọn Chi Tiết Thiết Bị > Mạng Lưới để thay đổi kết nối Wi-Fi.
Thời gian kết nối quá lâu ?	<ul style="list-style-type: none"> • Hãy đảm bảo rằng, khi kết nối, khoảng cách từ camera tới Router, và khoảng cách từ camera đến điện thoại chỉ trong vòng 5m (16.4ft) • Kiểm tra cấu hình Wi-Fi của Router: Chọn kênh Tự Động và để chế độ 11bgn hỗn hợp.
Khi nào thẻ nhớ đầy ? Dữ liệu đã ghi được sẽ được lưu như thế nào ?	<ul style="list-style-type: none"> • Khi thẻ nhớ đầy, hệ thống sẽ ghi đè lên dữ liệu đã quay được trước đó. Ưu tiên lưu trữ theo thời gian thực.
Dữ liệu ghi được sẽ được lưu trữ tại đâu ?	<ul style="list-style-type: none"> • Nếu bạn đã kích hoạt Lưu Trữ Đám Mây và cài đặt thẻ Micro SD, bản ghi sẽ được lưu vào thẻ và đám mây. Nếu đã vô hiệu hoá Lưu Trữ Đám Mây, bản ghi sẽ được lưu vào thẻ nhớ. Khi xem trực tiếp, nếu sử dụng tính năng Ghi Màn Hình, dữ liệu sẽ được lưu trên điện thoại của bạn.
Thiết bị không trực tuyến ?	<p>Kiểm tra đèn trạng thái:</p> <ul style="list-style-type: none"> • Màu xanh: Kiểm tra Router có được kết nối mạng hay không. Nếu có, vui lòng khởi động lại camera. • Nháy đỏ: Mặc định camera và cấu hình lại. • Màu đỏ: Camera bị lỗi.

คู่มือการใช้งานฉบับย่อ

Cruiser 4MP

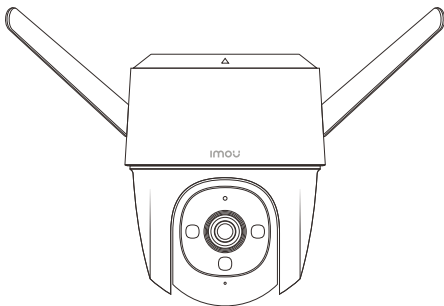

ยินดีต้อนรับ

TH

ขอขอบคุณที่เลือกใช้ IMOU
พวกเราทุ่มเทเพื่อสินค้าอัจฉริยะในบ้านที่ใช้งานง่ายสำหรับคุณ
ในกรณีที่พบปัญหาจากการใช้สินค้า
โปรดติดต่อทีมบริการของเราก่อนที่จะส่งคืนสินค้า

ติดต่อเรา: service.global@imoulife.com
ดูคำถามที่พบบ่อย imoulife.com/support/help



บรรจุภัณฑ์

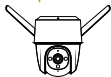

กล้อง ×1



คู่มือการใช้งานฉบับย่อ ×1



อะแดปเตอร์จ่ายไฟ ×1



น๊อตยึดกล้อง ×1

TH



เทมเพลตติดตั้ง ×1



ตัวยึด ×1



คอนเนคเตอร์กันน้ำ ×1

แนะนำกล้อง



พอร์ตแลน



แหล่งจ่ายไฟ



ช่องใส่ไมโครเอสดีการ์ด



สปอตไลท์



เสาอากาศ
Wi-Fi



ปุ่มรีเซ็ต



ไฟ LED
แสดงสถานะ



ไมโครโฟน



LED อินฟราเรด



เลนส์

หมายเหตุ: หยุดจ่ายไฟที่กล้องก่อนจะติดตั้งกล้องหรือถอดเอสดีการ์ด

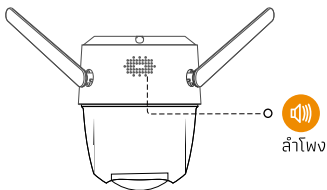

- หมายเหตุ: 1. กดปุ่มรีเซตค้างเป็นเวลา 10 วินาทีเพื่อรีเซทกล่อง
2. กดปุ่มรีเซตติดต่อกัน 2 ครั้งเพื่อเปิดฮีตสปอต

ดูตารางแสดงความหมายของไฟ LED แสดงสถานะกล่องข้างล่าง

สถานะไฟLED	สถานะอุปกรณ์
ปิด	<ul style="list-style-type: none"> ● ปิดเครื่อง/ปิดไฟLED ● รีบูตเครื่องหลังจากรีเซ็ต
ไฟสีแดงติดค้าง	<ul style="list-style-type: none"> ● กำลังบูทเครื่อง ● อุปกรณ์ทำงานผิดปกติ
ไฟสีแดงกะพริบ	<ul style="list-style-type: none"> ● ไม่สามารถเชื่อมต่อเน็ตเวิร์ค ● การเชื่อมต่อผิดพลาด
ไฟสีเขียวกะพริบ	<ul style="list-style-type: none"> ● พร้อมสำหรับการตั้งค่าเครือข่าย ● พร้อมสำหรับการเชื่อมต่อ
ไฟสีเขียวติดค้าง	<ul style="list-style-type: none"> ● ทำงานปกติ
ไฟสีเขียวและสีแดงกะพริบสลับกัน	<ul style="list-style-type: none"> ● อัปเดตเฟิร์มแวร์

1 ดาว์นโหลดแอป

TH

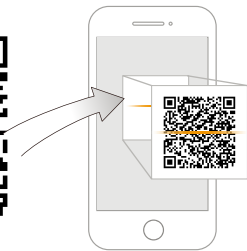

i Tips

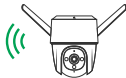
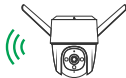

เพื่อให้การทำงานของระบบไร้สายมีประสิทธิภาพสูงสุด

โปรดตรวจสอบให้แน่ใจว่าไม่มีสิ่งกีดขวางหรือสนามแม่เหล็กไฟฟ้ารบกวนระหว่างกล้องกับเราเตอร์

2 เพิ่มอุปกรณ์เข้าแอป

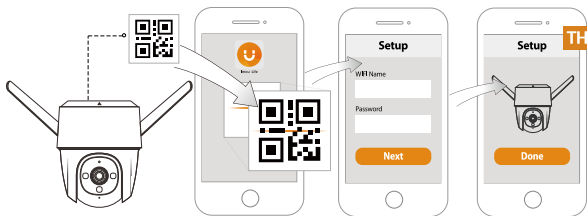



3 การติดตั้งกล้อง

หมายเหตุ: ตรวจสอบว่าพื้นผิวที่ยึดเกาะแข็งแรงพอที่จะรับน้ำหนักของกล้องและตัวยึดได้อย่างน้อย 3 เท่า

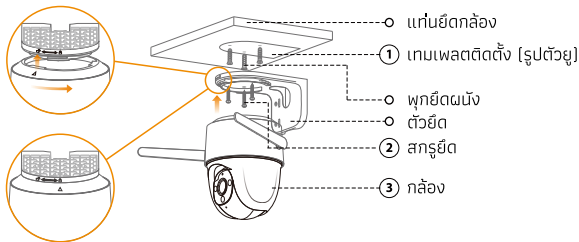
ติดตั้งบนเพดาน



- ① ลอกแผ่นเกมเพลตติดตั้งรูปตัวยู และติดในจุดที่ต้องการติดตั้ง
- ② เจาะรูที่จุดติดตั้งตามเครื่องหมายแผ่นเกมเพลตติดตั้งและใส่พุกยึดผนังตามต้องการ
- ③ ยึดตัวยึดเข้ากับจุดติดตั้งด้วยสกรูยึดที่ให้มา
- ④ ปรับ Δ ที่ด้านบนของกล่องให้ตรงกับ  บนตัวยึด จากนั้นใส่ทั้ง 2 ส่วนเข้าด้วยกัน
- ⑤ หมุนกล่องทวนเข็มนาฬิกาจนกระทั่งล็อก ตรวจสอบว่า Δ ตรงกับ 
- ⑥ เปิดกล่องและจัดมุมกล่องตามความเหมาะสม

ติดตั้งบนกำแพง

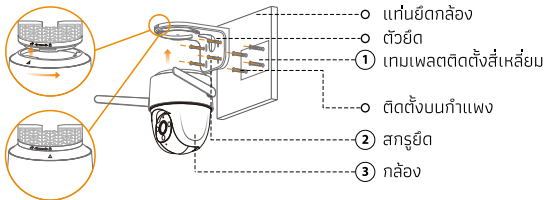

- ① ลอกแผ่นเกมเพลตติดตั้งสี่เหลี่ยม และติดในจุดที่ต้องการติดตั้ง
- ② เจาะรูที่จุดติดตั้งตามเครื่องหมายแผ่นเกมเพลตติดตั้งและใส่พุกยึดผนังตามต้องการ
- ③ ยึดตัวยึดเข้ากับจุดติดตั้งด้วยสกรูยึดที่ให้มา
- ④ ปรับ Δ ที่ด้านบนของกล่องให้ตรงกับ  บนตัวยึด จากนั้นใส่ทั้ง 2 ส่วนเข้าด้วยกัน



- ⑤ หมุนกล้อทวนเข็มนาฬิกาจนกระทั่งล็อก ตรวจสอบว่า \triangle ตรงกับ 
- ⑥ เปิดกล้อและจัดมุมกล้องตามความเหมาะสม

TH

ติดตั้งบนเสา

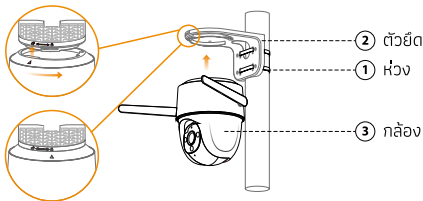
-  **หมายเหตุ:** 1. ตรวจสอบว่าเสาแข็งแรงพอที่จะรับน้ำหนักของกล้องและตัวยึดได้อย่างน้อย 3 เท่า
2. ห่วงไม้ได้อยู่ในชุดติดตั้ง โปรดเตรียมไว้ล่วงหน้า



- ① ร้อยห่วงผ่านรูยึดบนตัวยึดจากนั้นติดตั้งตัวยึดเข้ากับเสา
- ② ปรับ \triangle ที่ด้านบนของกล้องให้ตรงกับ  บนตัวยึด จากนั้นใส่ทั้ง 2 ส่วนเข้าด้วยกัน
- ③ หมุนกล้อทวนเข็มนาฬิกาจนกระทั่งล็อก ตรวจสอบว่า \triangle ตรงกับ 
- ④ เปิดกล้อและจัดมุมกล้องตามความเหมาะสม



DC
12V1A

แนวทางการแก้ไขปัญหา

คำถาม	คำตอบ
อุปกรณ์ไม่สามารถบูตได้หรือทำงานผิดพลาด ?	<ul style="list-style-type: none"> ตรวจสอบไฟLEDแสดงสถานะ- ถ้าสัญญาณไฟไม่เป็นสีเขียว ให้กดปุ่มรีเซ็ตค้างไว้ 10 วินาทีเพื่อรีเซตกล่อง
วิธีเชื่อมต่อกล่องเข้ากับ Wi-Fi อื่น ?	<ul style="list-style-type: none"> กรณีก่อนออนไลน์อยู่ เข้าไปที่รายละเอียดของอุปกรณ์ (Device Details) > การตั้งค่าเครือข่าย (Network Config) เพื่อเปลี่ยนการเชื่อมต่อ Wi-Fi บนแอป ถ้ากล่องออฟไลน์อยู่ รีเซตกล่องแล้วทำการเชื่อมต่อกล่องใหม่อีกครั้ง
การเชื่อมต่อใช้เวลาานเกินไป ?	<ul style="list-style-type: none"> ตรวจสอบระยะระหว่างกล่องกับเราเตอร์ และระยะระหว่างกล่องกับโทรศัพท์ว่าอยู่ในระยะ 5 เมตรตอนทำการเชื่อมต่อ ตรวจสอบการตั้งค่า Wi-Fi อุปกรณ์เราเตอร์: ตั้งค่าช่องทางเป็นอัตโนมัติ และเลือกโหมด 11bgn แบบผสม
เมื่อใดโครเอสติการ์ดเต็มจะบันทึกวิดีโออย่างไร ?	<ul style="list-style-type: none"> กรณีที่ไมโครเอสติการ์ดเต็ม ระบบจะทำการบันทึกกับวิดีโอของเก่าสำรองข้อมูลที่สำคัญก่อนที่จะถูกบันทึกกับ
วิดีโอถูกบันทึกไว้ที่ไหน ?	<ul style="list-style-type: none"> ถ้าคุณเปิดใช้งานการจัดเก็บผ่านคลาวด์ และใส่ไมโครเอสติการ์ด การบันทึกจะถูกจัดเก็บไว้ที่การ์ดและคลาวด์ ถ้าปิดการใช้งานการจัดเก็บผ่านคลาวด์ การบันทึกจะถูกบันทึกในเอสติการ์ด การอัปเดตวิดีโอระหว่างดูภาพสดหรือดูภาพย้อนหลังจะถูกจัดเก็บในโทรศัพท์ของคุณ
อุปกรณ์ออฟไลน์ ?	<p>ตรวจสอบสัญญาณไฟแสดงสถานะ:</p> <ul style="list-style-type: none"> ไฟสีเขียวติดค้าง: ตรวจสอบว่าเราเตอร์สามารถเชื่อมต่อกับอินเทอร์เน็ตได้หรือไม่ ถ้าเครือข่ายเชื่อมต่ออยู่ รีเซ็ตกล่อง ไฟสีแดงกระพริบ: ให้รีเซตกล่อง และตั้งค่ากล่องใหม่อีกครั้ง ไฟสีแดงติดค้าง: กล่องทำงานผิดพลาด

Panduan Ringkas

Cruiser 4MP

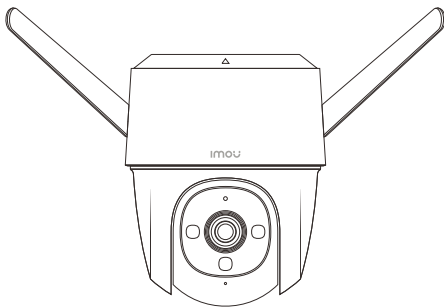

Selamat Datang

BM

Terima kasih kerana memilih IMOU.
Kami setia menyediakan produk rumah pintar yang mudah untuk anda. Sekiranya anda menghadapi masalah menggunakan produk, sila hubungi pasukan perkhidmatan kami sebelum mengembalikan produk anda.

Mel perkhidmatan kami: service.global@imoulife.com

Soalan lazim boleh didapati di
imoulife.com/support/help



Kandungan Bungkus

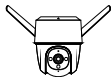

Kamera x1



Panduan Ringkas x1



Penyesuai Elektrik x1



Skrup Pakej x1



Templat
Pemasangan x1



Pendakap
Pemasangan x1



Penyambung
Kalis Air x1

BM

Pengenalan Kamera



Ethernet Port



Elektrik



Slot Kad Mikro-SD



Lampu Sorotan



Sambungan
Wifi



Butang
Tetapan
semula



Petunjuk
LED



mikrofon



Infrared LED



Lensa

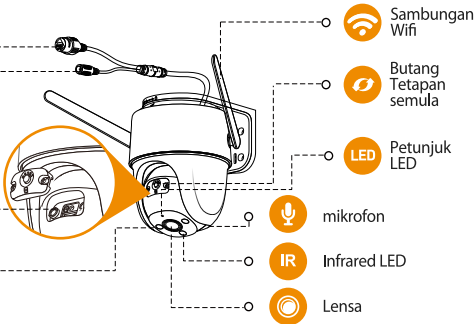

Nota: Memutuskan sambungan kamera dari elektrik sebelum memasang atau mengeluarkan kad SD Kad.

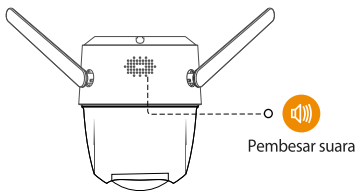

- Nota:**
1. Tekan dan tahan butang reset selama 10 s untuk menetapkan semula kamera.
 2. Tekan dua kali butang reset untuk mengaktifkan hotspot kamera.

Lihat jadual di bawah untuk definisi tingkah laku LED kamera.

Status Petunjuk LED	Status Peranti
Tutup	<ul style="list-style-type: none"> ● Dimatikan / LED dimatikan ● Boot semula selepas ditetapkan semula
Merah Solid	<ul style="list-style-type: none"> ● Booting ● Peranti Tidak berfungsi
Berkelip merah	<ul style="list-style-type: none"> ● Sambungan rangkaian gagal ● Berpasangan Gagal
Berkelip hijau	<ul style="list-style-type: none"> ● Bersedia untuk konfigurasi rangkaian ● Sedia berpasangan
Hijau Solid	<ul style="list-style-type: none"> ● Beroperasi dengan betul
Berkelip hijau dan merah secara bergantian	<ul style="list-style-type: none"> ● Mengemas kini firmware

1 Muat turun APP

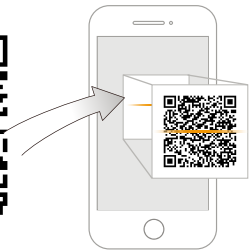

BM



Imou Life



Download on the
App Store



GET IT ON
Google play



Windows

i Tips

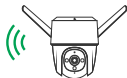
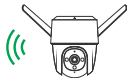

Untuk memastikan prestasi tanpa wayar yang terbaik, pastikan tidak ada halangan dan elektromagnetik gangguan antara kamera dan penghalang.

2 Tambahkan peranti ke APP

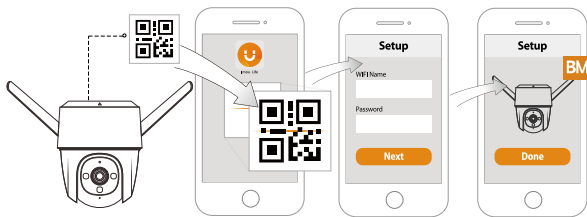



3 Memasang Kamera

Nota: Pastikan permukaan pelekap cukup kuat untuk menahan sekurang-kurangnya tiga kali ganda berat kamera dan pendakap.

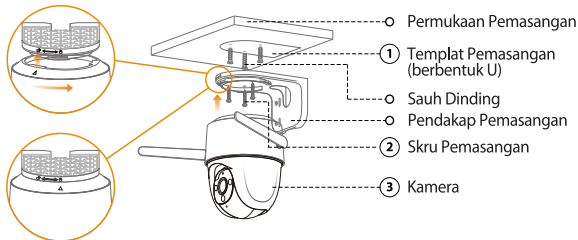
Pemasangan Siling



- ① Tanggalkan pelekap pemasangan berbentuk U dan pasangkannya ke kawasan pemasangan yang dikehendaki.
- ② Menebuk lubang ke permukaan pelekap yang telah tanda atas pelekap pemasangan dan kemudian masukkan sauh dinding mengikut keperluan.
- ③ Kunci pendakap pemasangan ke permukaan dengan skru pemasangan yang disertakan.
- ④ Sejajarkan \triangle di bahagian atas kamera dengan  pendakap, kemudian pasang kedua-dua bahagian bersama.
- ⑤ Putar kamera berlawanan arah jam sehingga terkunci. Pastikan \triangle sejajar dengan .
- ⑥ Hidupkan kamera dan kemudian tetapkan sudut dengan betul.

Pemasangan Dinding

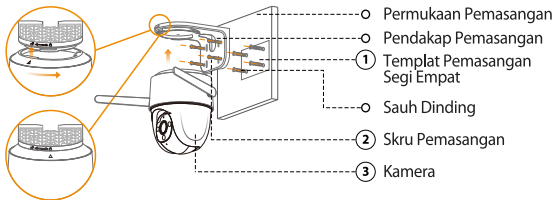

- ① Tanggalkan templat pelekap segi empat tepat dan lekatkan ke kawasan pemasangan yang dikehendaki.
- ② Menebuk lubang ke permukaan pelekap yang telah tanda atas pelekap pemasangan dan kemudian masukkan sauh dinding mengikut keperluan.
- ③ Kunci pendakap pemasangan ke permukaan dengan skru pemasangan yang disertakan.
- ④ Sejajarkan \triangle di bahagian atas kamera dengan  pendakap, kemudian pasang kedua-dua bahagian bersama.



- 5 Putar kamera berlawanan arah jam sehingga terkunci. Pastikan \triangle sejajar dengan .
- 6 Hidupkan kamera dan kemudian tetapkan sudut dengan betul.

Pemasangan di Tiang

BM

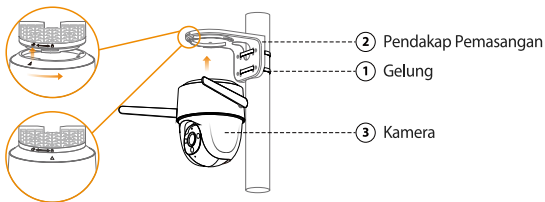
-  **Nota:** 1. Pastikan tiang cukup kuat untuk menahan sekurang-kurangnya tiga kali berat kamera dan pendakap.
2. Gelung tidak disediakan. Sila sediakan mereka terlebih dahulu.



- 1 Jalurkan gelung melalui lubang pelekap pada pendakap, kemudian pasangkan pendakap ke tiang.
- 2 Sejajarkan \triangle di bahagian atas kamera dengan  pendakap, kemudian pasangkan kedua-dua bahagian bersama.
- 3 Putar kamera berlawanan arah jam sehingga terkunci. Pastikan \triangle sejajar dengan .
- 4 Hidupkan kamera dan kemudian tetapkan sudut dengan betul.

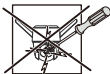

DC
12V1A

Penyelesaian masalah

Soalan	Jawapan
"Perangkat tidak dapat boot atau berfungsi seperti yang dijangkakan?"	<ul style="list-style-type: none">• Periksa status penunjuk LED. Jika lampu tidak berwarna hijau, tekan dan tahan butang reset selama 10 s untuk menetapkan semula kamera.
Bagaimana untuk menghubungkan kamera ke Wi-Fi lain rangkaian?	<ul style="list-style-type: none">• Jika kamera dalam talian, pilih Device Details > Network Config untuk mengubah sambungan Wi-Fi dalam aplikasi.• Jika kamera di luar talian, tetapkan semula kamera, kemudian konfigurasi kamera lagi.
Sambungan terlalu lama?	<ul style="list-style-type: none">• Periksa jarak antara kamera dan penghalang, dan jarak antara kamera dan telefon pintar kedua-duanya berada dalam jarak 5 m (16.4 kaki) semasa sambungan.• Periksa konfigurasi Wi-Fi penghalang: Pilih saluran automatik, dan mod ke 11bgn mixed.
Apabila mikro SD kad penuh, bagaimana video yang dirakam disimpan?	<ul style="list-style-type: none">• Apabila mikro SD kad penuh, sistem akan menimpa video yang dirakam sebelumnya. Simpan maklumat penting dalam masa.
Mana video yang dirakam disimpan?	<ul style="list-style-type: none">• Jika anda telah mengaktifkan Penyimpanan awan dan memasang kad SD mikro, rakaman akan disimpan ke kad dan awan. Sekiranya Penyimpanan awan tidak mengaktifkan, rakaman akan disimpan ke kad SD. Video yang dirakamkan semasa siaran langsung ataupun main balik disimpan di telefon anda.
Peranti di luar talian?	<p>Periksa status penunjuk:</p> <ul style="list-style-type: none">• Hijau Solid Periksa sama ada penghalang boleh menyambung ke Internet. Sekiranya rangkaian disambungkan, mulakan semula kamera.• Berkelip merah: Tetapkan semula kamera, kemudian konfigurasi semula kamera.• Merah Solid: Kamera rosak.



Panduan Singkat

Cruiser 4MP

ID

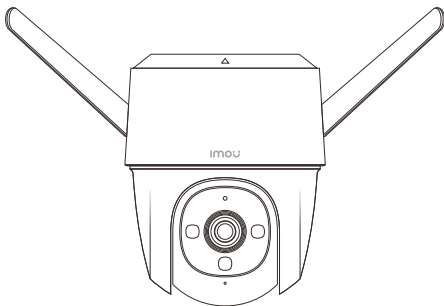

Selamat Datang

ID

Terima kasih sudah memilih IMOU.

Kami berdedikasi untuk menyediakan produk rumah pintar yang mudah untuk Anda. Jika Anda mengalami masalah dalam menggunakan produk, silakan hubungi tim layanan kami sebelum mengembalikan produk Anda.

Layanan email kami: service.global@imoulife.com

Pertanyaan yang sering diajukan dapat ditemukan di imoulife.com/support/help



Isi paket

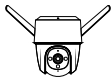

Kamera x1



Panduan Singkat x1



Adaptor Daya x1



Paket Sekrup x1

ID



Template
Pemasangan x1



Braket Pemasangan x1



Konektor
Tahan Air x1

Pengenalan Kamera

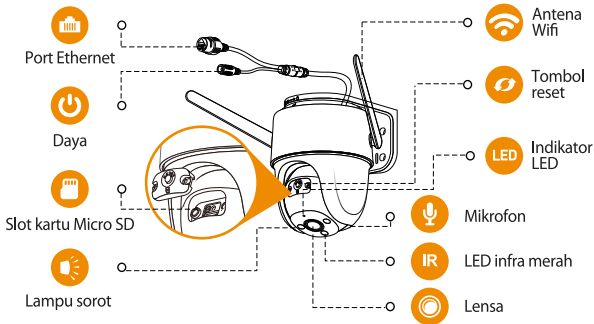

Catatan: Putuskan sambungan kamera dari daya sebelum memasang atau mengeluarkan kartu SD-nya.

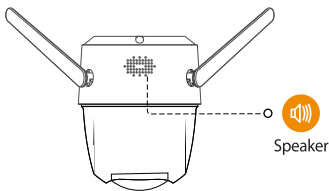

- Catatan:** 1. Tekan dan tahan tombol reset selama 10 detik untuk mengatur ulang kamera.
2. Tekan dua kali tombol reset untuk mengaktifkan hotspot kamera.

Lihat tabel di bawah untuk definisi perilaku LED kamera.

Status indikator LED	Status Perangkat
Mati	<ul style="list-style-type: none"> ● Daya mati/LED di matikan ● Rebooting setelah reset
Merah Pekat	<ul style="list-style-type: none"> ● Booting ● Perangkat rusak
Berkedip Merah	<ul style="list-style-type: none"> ● Koneksi jaringan gagal ● Gagal Berpasangan
Berkedip hijau	<ul style="list-style-type: none"> ● Siap untuk konfigurasi jaringan ● Siap untuk berpasangan
Hijau Solid	<ul style="list-style-type: none"> ● Beroperasi dengan benar
Berkedip hijau dan merah secara bergantian	<ul style="list-style-type: none"> ● Memperbaharui firmware

1 Unduh APP

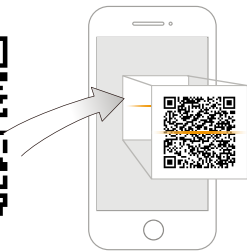

ID



Imou Life



Download on the
App Store



GET IT ON
Google play



Windows

i Tips

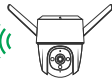
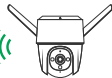

Untuk memastikan performa nirkabel terbaik, pastikan tidak ada penghalang dan gangguan elektromagnetik antara kamera dan router.

2 Tambahkan perangkat ke APP

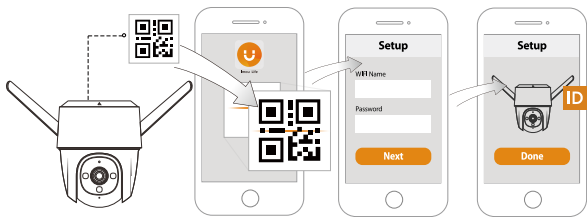



3 Pemasangan kamera

Catatan: Pastikan permukaan pemasangan cukup kuat untuk menahan setidaknya tiga kali berat kamera dan braket.

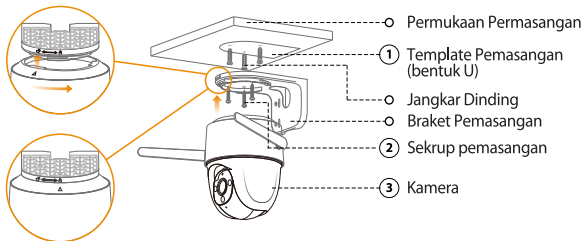
Pemasangan di Plafon



- ① Lepaskan template pemasangan berbentuk U dan tempelkan ke area pemasangan yang diinginkan.
- ② Bor lubang ke permukaan pemasangan sebagai tanda template pemasangan dan kemudian masukkan jangkar dinding sesuai kebutuhan.
- ③ Kencangkan braket pemasangan ke permukaan dengan sekrup pemasangan yang disertakan.
- ④ Sejajarkan \triangle di bagian atas kamera dengan  pada braket, lalu pasang kedua bagian tersebut.
- ⑤ Putar kamera berlawanan arah jarum jam hingga terkunci. Pastikan \triangle sejajar dengan .
- ⑥ Nyalakan kamera lalu sesuaikan sudutnya dengan benar.

Pemasangan di Dinding

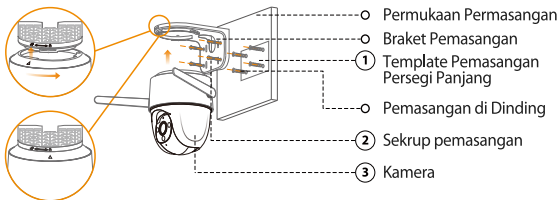

- ① Lepaskan template pemasangan persegi panjang dan tempelkan ke area pemasangan yang diinginkan.
- ② Bor lubang ke permukaan pemasangan sebagai tanda template pemasangan dan kemudian masukkan jangkar dinding sesuai kebutuhan.
- ③ Kencangkan braket pemasangan ke permukaan dengan sekrup pemasangan yang disertakan.
- ④ Sejajarkan \triangle di bagian atas kamera dengan  pada braket, lalu pasang kedua bagian tersebut.



- Putar kamera berlawanan arah jarum jam hingga terkunci. Pastikan \triangle sejajar dengan .
- Nyalakan kamera lalu sesuaikan sudutnya dengan benar.

Pemasangan Tiang

-  **Catatan:** 1. Pastikan tiang cukup kuat untuk menahan setidaknya tiga kali lipat berat kamera dan braket.
2. Lingkaran tidak tersedia. Harap persiapkan sebelumnya.

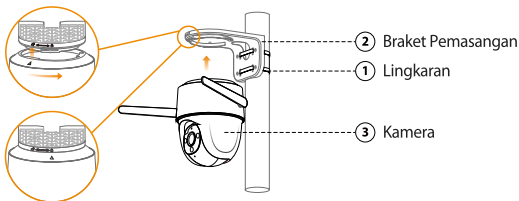
ID



- Masukkan lingkaran melalui lubang pemasangan pada braket, lalu pasang braket ke tiang.
- Sejajarkan \triangle di bagian atas kamera dengan  pada braket, lalu pasang kedua bagian tersebut.
- Putar kamera berlawanan arah jarum jam hingga terkunci. Pastikan \triangle sejajar dengan .
- Nyalakan kamera lalu sesuaikan sudutnya dengan benar.



DC
12V1A

Penyelesaian Masalah

Pertanyaan	Jawaban
Perangkat tidak bisa boot atau bekerja seperti yang diharapkan?	<ul style="list-style-type: none">• Periksa status indikator LED. Jika lampu tidak menyala hijau, tekan dan tahan tombol reset selama 10 detik untuk mengatur ulang kamera.
Bagaimana menghubungkan kamera ke jaringan Wi-Fi lain?	<ul style="list-style-type: none">• Jika kamera sedang online, pilih Device Details> Network Config untuk mengubahnya koneksi Wi-Fi di aplikasi.• Jika kamera sedang offline, setel ulang kamera, lalu konfigurasi kamera lagi.
Koneksi terlalu lama?	<ul style="list-style-type: none">• Periksa apakah jarak antara kamera dan router dan antara kamera dan ponsel pintar keduanya dalam jarak 5 m (16,4 kaki) selama koneksi.• Periksa konfigurasi Wi-Fi dari router: Pilih saluran ke otomatis dan mode 11bgn di kombinasi
Ketika kartu micro SD penuh, bagaimana video yang direkam disimpan?	<ul style="list-style-type: none">• Saat kartu micro SD sudah penuh, sistem akan menimpa rekaman video sebelumnya. Simpan informasi penting tepat waktu.
Di mana video yang direkam disimpan?	<ul style="list-style-type: none">• Jika Anda telah mengaktifkan penyimpanan cloud dan memasang kartu micro SD, file rekaman akan disimpan ke kartu dan cloud. Jika penyimpanan cloud dinonaktifkan, rekaman disimpan ke kartu SD. Video direkam selama tinjauan langsung atau pemutaran disimpan di ponsel Anda.
Perangkat sedang offline?	<p>Periksa status indikator :</p> <ul style="list-style-type: none">• Hijau solid: Periksa apakah router dapat terhubung ke Internet. Jika jaringan terhubung, restart kamera.• Berkedip merah: Atur ulang kamera, lalu konfigurasi kamera lagi.• Merah Solid : Kamera Rusak



クイックスタートガイド

Cruiser 4MP

JP

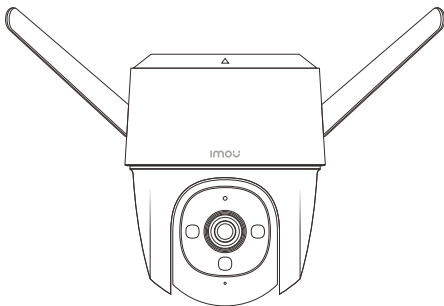

ようこそ

IMOUをお買い上げいただき誠にありがとうございます。
簡単に使えるスマートホーム製品をお届けするため努力
しております。本製品の使用中に問題が発生した場合、製品
を返却する前に、当社サービスチームにご連絡ください。

JP

当社のサービスメール: service.global@imoulife.com

よく尋ねられる質問は

imoulife.com/support/helpに掲載されています



同梱品

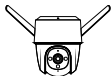

カメラ ×1



クイックスタートガイド ×1



電源アダプタ ×1



ネジセット ×1



取付プレート ×1



取付金具 ×1



耐水コネクター ×1

JP

カメラについて

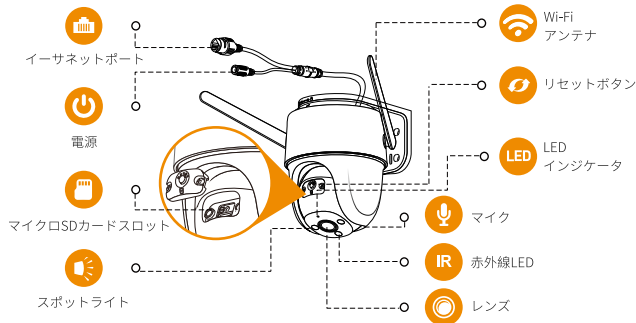

注意: カメラを取り付ける前、またはSDカードを取り出す前は、カメラの電源をお切りください。

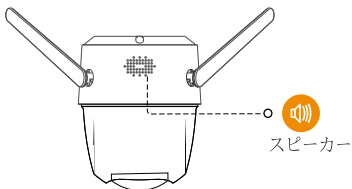

- 注意：**
1. リセットボタンを10秒間長押ししてカメラをリセットします。
 2. リセットボタンを2回押し、カメラのホットスポット機能を有効にします。

カメラのLEDインジケータの表示内容については、下記の対応表をご参照ください。

LEDインジケータのステータス	デバイスのステータス
オフ	<ul style="list-style-type: none"> ● 電源オフ/LEDオフ ● リセット後の再起動
赤で点灯	<ul style="list-style-type: none"> ● 起動中 ● デバイス異常
赤で点滅	<ul style="list-style-type: none"> ● ネットワーク接続に失敗しました ● ペ어링に失敗
緑で点滅	<ul style="list-style-type: none"> ● ネットワーク設定の準備完了 ● ペ어링の準備完了
緑で点灯	<ul style="list-style-type: none"> ● 正常に動作中
緑と赤が交互に点滅	<ul style="list-style-type: none"> ● ファームウェアの更新中

1 アプリのダウンロード完了

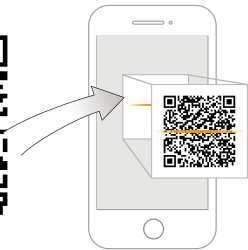

JP



i Tips

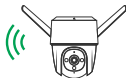
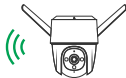

ワイヤレス動作を最良の状態に維持するため、カメラとルータの間に、障害物や電磁妨害がないことを確認してください。

2 アプリへのデバイス追加

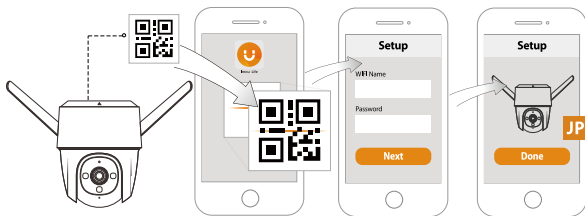



3 カメラのインストール

注意： 取付面にカメラとブラケットの3倍以上の重量に耐える強度があることをご確認ください。

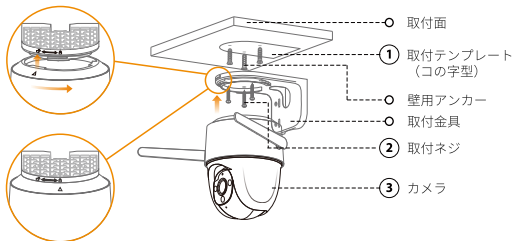
天井取付



- ① コの字型の取付テンプレートをはがして、設置したい場所に貼り付けます。
- ② 取付面に取付テンプレートのマークに従って穴を開けます。必要に応じて壁用アンカーを挿入します。
- ③ 付属の取付ネジで取付面に取付ブラケットを固定します。
- ④ カメラ上部にある △ と取付ブラケットにある  を一致させてから、2つのパーツを合わせます。
- ⑤ カメラをロックされるまで反時計回りに回転させます。△ と  が一致していることを確認してください。
- ⑥ カメラの電源を入れ、適切な角度に調整します。

壁面取付

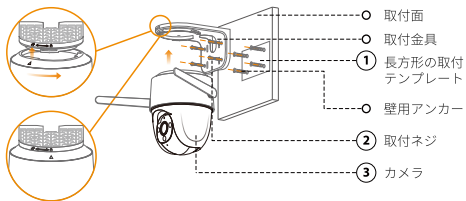

- ① コの字型の取付テンプレートをはがして、設置したい場所に貼り付けます。
- ② 取付面に取付テンプレートのマークに従って穴を開けます。必要に応じて壁用アンカーを挿入します。
- ③ 付属の取付ネジで取付面に取付ブラケットを固定します。
- ④ カメラ上部にある △ と取付ブラケットにある  を一致させてから、2つのパーツを合わせます。

- ⑤ カメラをロックされるまで反時計回りに回転させます。△と🔒が一致していることを確認してください。
- ⑥ カメラの電源を入れ、適切な角度に調整します。

ポールマウント

- ⚠ **注意:** 1. ポールにカメラとブラケットの3倍以上の重量に耐える強度があることをご確認ください。
2. リングは付属していません。事前にご準備ください。

JP

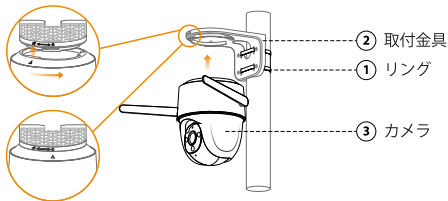

- ① リングをブラケットの取付穴に通してから、ブラケットをポールに取り付けます。
- ② カメラ上部にある△と取付ブラケットにある🔒を一致させてから、2つのパーツを合わせます。
- ③ カメラをロックされるまで反時計回りに回転させます。△と🔒が一致していることを確認してください。
- ④ カメラの電源を入れ、適切な角度に調整します。

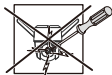

DC
12V1A

トラブルシューティング

質問	回答
カメラが起動しません。または、思ったように動作しません。	<ul style="list-style-type: none">LEDインジケータのステータスを確認してください。LEDインジケータが緑に点灯していない場合は、リセットボタンを10秒間長押ししてカメラをリセットします。
カメラを別のWi-Fiネットワークに接続する方法を教えてください。	<ul style="list-style-type: none">カメラがオンラインの場合、[デバイスの詳細]→[ネットワーク設定]を選択し、アプリでWi-Fi接続に変更します。カメラがオフラインの場合、カメラをリセットし、カメラを再設定します。
接続に時間がかかりすぎます。	<ul style="list-style-type: none">接続中にカメラとルーターの距離、カメラとスマートフォンの距離がどちらも5メートル(16.4フィート)以内であるかどうか確認してください。ルーターによるWi-Fi設定の確認方法：チャンネルはオート、モードは11bgn ミックスを選択します。
マイクロSDカードが一杯になった場合、録画した動画はどのように保存されますか？	<ul style="list-style-type: none">マイクロSDカードが一杯になると、システムはそれまでに録画した動画を上書きします。よって、大切な情報は適時、保存してください。
録画した動画はどこに保存されますか？	<ul style="list-style-type: none">クラウドストレージを有効にしてマイクロSDカードを挿入した場合、録画した動画はマイクロSDカードとクラウドストレージの両方に保存されます。クラウドストレージを無効にした場合、録画した動画はSDカードに保存されます。ライブビューや再生中に録画された動画は、スマートフォンに保存されます。
デバイスがオフラインなのはなぜ？	<p>インジケータのステータスを確認してください：</p> <ul style="list-style-type: none">緑で点灯：ルーターがインターネットに接続できるかどうかを確認します。ネットワークに接続されている場合は、カメラを再起動してください。赤で点滅：カメラをリセットして、再度カメラの設定を行ってください。赤で点灯：カメラは故障しています。



퀵 스타트 가이드

Cruiser 4MP

KR

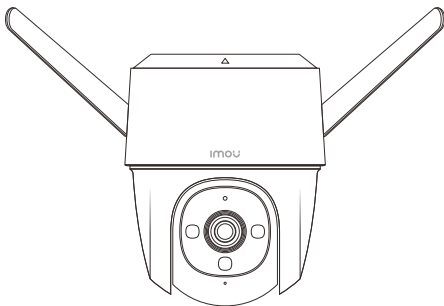

환영합니다

IMOU를 선택해주셔서 감사합니다.

우리는 고객에게 쉬운 스마트 홈 제품을 제공하기 위해 노력하겠습니다. 제품 사용에 문제가 있으면 고객님의 제품을 반품하기 전에 우리의 서비스 팀에게 연락 주십시오.

우리 서비스 메일: service.global@imoulife.com

자주 묻는 질문:

imoulife.com/support/help



포장 내용물

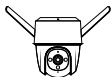

카메라 x1



퀵 스타트 가이드 x1



파워 어댑터 x1



스크류 패키지 x1



장착 치수판 x1



마운팅 브라켓 x1



방수 커넥터 x1

KR

카메라 설치

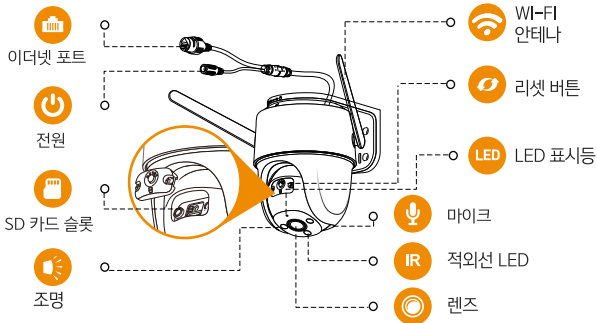

❗ **공지:** 카메라를 설치하거나 SD 카드를 꺼내기 전에 전원에서 카메라를 분리하십시오.

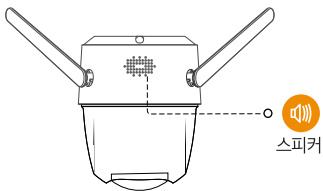

- 공지:** 1. 리셋 버튼을 10초간 길게 눌러 카메라를 리셋을 합니다.
 2. 카메라의 핫스팟을 활성화하려면 리셋 버튼을 두 번 누르십시오.

카메라의 LED 동작에 대한 의미는 아래 표를 참조하십시오.

LED 표시등 상태	장치 상태
꺼짐	<ul style="list-style-type: none"> ● 전원 꺼짐/LED 꺼짐 ● 재설정 후 재부팅 중
고정 빨간색	<ul style="list-style-type: none"> ● 부팅 ● 장치 오작동
점멸 빨간색	<ul style="list-style-type: none"> ● 네트워크 연결 실패 ● 연결 실패
점멸 초록색	<ul style="list-style-type: none"> ● 네트워크 구성 준비 완료 ● 연결 준비
고정 초록색	<ul style="list-style-type: none"> ● 정상 작동중
녹색과 빨간색 번갈아 깜박임	<ul style="list-style-type: none"> ● 펌웨어 업데이트

1 APP 다운로드

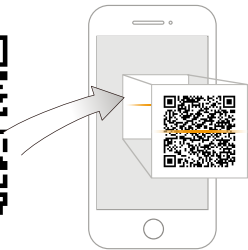

KR



i Tips

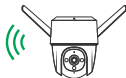
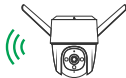

최상의 무선 성능을 보장하려면 카메라와 라우터 사이에 장애물과 전자파 간섭이 없는지 확인하십시오.

2 APP에 장치 추가

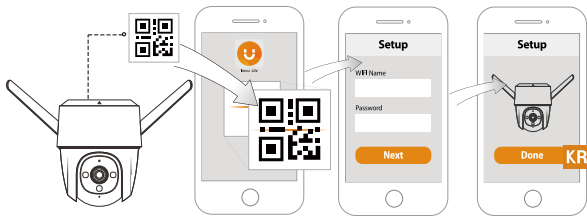



3 카메라 설치

공지: 마운팅 표면이 카메라와 브래킷 무게의 최소 3 배 이상을 지탱할 수 있을만큼 튼튼한 지 확인하십시오.

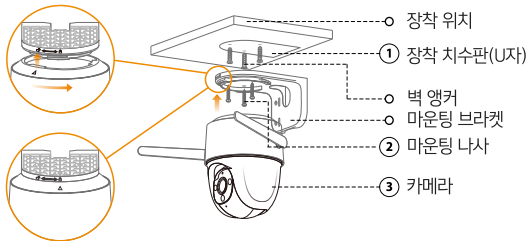
천장 마운트



- ① U자형 마운팅 치수판을 원하는 설치 부위에 붙이십시오.
- ② 장착 치수판에 표시에 따라 장착 표면에 구멍을 뚫은 다음 벽 앵커를 삽입하십시오.
- ③ 포함된 장착 나사로 마운팅 브라켓을 표면에 고정하십시오.
- ④ 카메라 위에 △와 브라켓의 를 정렬한 다음 두 부분을 장착하고 고정하십시오.
- ⑤ 잠길 때까지 카메라를 역방향으로 돌립니다. △와 를 정렬하십시오.
- ⑥ 카메라 전원을 켜 다음 각도를 적절하게 조정하십시오.

벽 마운트

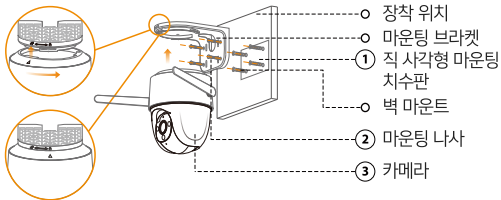

- ① 직사각형 장착 장치판을 원하는 설치 영역에 부착하십시오.
- ② 장착 치수판에 표시에 따라 장착 표면에 구멍을 뚫은 다음 벽 앵커를 삽입하십시오.
- ③ 포함된 장착 나사로 마운팅 브라켓을 표면에 고정하십시오.
- ④ 카메라 위에 △와 브라켓의 를 정렬한 다음 두 부분을 장착하고 고정하십시오.

- ⑤ 잠길 때까지 카메라를 역방향을 돌립니다. △ 와 🔒 를 정렬하십시오.
- ⑥ 카메라 전원을 켜 다음 각도를 적절하게 조정하십시오.

풀 마운트

- ⚠ **공지:** 1. 카메라와 브래킷의 3배 이상의 중량을 지탱할 수 있을 만큼 풀이 튼튼한지 확인하십시오.
 2. 후프는 제공되지 않습니다. 미리 준비해 두십시오.

KR

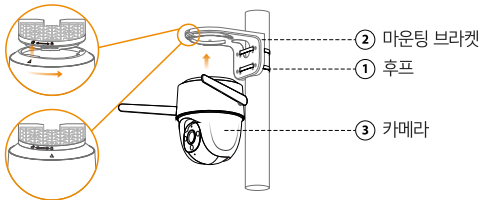

- ① 후프를 브래킷의 장착 구멍에 고정 후 브래킷을 풀에 부착하십시오.
- ② 카메라 위에 △ 와 브래킷의 🔒 를 정렬한 다음 두 부분을 장착하고 고정하십시오.
- ③ 잠길 때까지 카메라를 역방향을 돌립니다. △ 와 🔒 를 정렬하십시오.
- ④ 카메라 전원을 켜 다음 각도를 적절하게 조정하십시오.

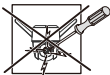

트러블 슈팅

질문	답변
장치가 부팅되지 않거나 예상대로 작동하지 않는 경우?	<ul style="list-style-type: none"> · LED 점등등 상태를 점검하십시오. 조명이 녹색으로 표시되지 않으면 재설정 버튼을 10초간 길게 눌러 카메라를 재설정하십시오.
카메라를 다른 Wi-Fi 네트워크로 연결 방법은?	<ul style="list-style-type: none"> · 카메라가 온라인 상태인 경우, Device Details > Network Config 를 선택하여 앱의 Wi-Fi 연결을 변경하십시오. · 카메라가 오프라인 상태일 경우 카메라를 재설정하고 다시 구성하십시오.
연결 시간이 너무 오래 걸릴때?	<ul style="list-style-type: none"> · 연결 중 카메라와 라우터, 그리고 카메라와 스마트폰 사이의 거리가 모두 5m(16.4ft) 이내인지 확인하십시오. · 라우터의 Wi-Fi 구성을 확인하십시오. 자동화할 채널과 혼합할 11bn 모드를 선택하십시오.
마이크로 SD 카드가 가득 찼을 때 녹화된 비디오는 어떻게 저장되는가요?	<ul style="list-style-type: none"> · 마이크로 SD 카드가 가득 차면 시스템이 이전에 녹화된 비디오를 덮어쓴다. 중요한 정보는 꼭 사전에 용량 확인 후 저장하십시오.
녹화된 비디오는 어디에 저장되는가요?	<ul style="list-style-type: none"> · 클라우드 저장소를 활성화하고 마이크로 SD 카드를 설치했다면, 기록들은 카드와 클라우드에 모두 저장될 것입니다. 클라우드 저장소가 비활성화된 경우, 기록은 SD 카드에 저장됩니다. 라이브 보기 또는 재생 중에 녹화된 동영상은 핸드폰에 저장됩니다.
장치가 오프라인 상태일때 ?	<p>표시등 상태 점검:</p> <ul style="list-style-type: none"> · 녹색 불 고정: 라우터가 인터넷에 연결할 수 있는지 확인하십시오. 네트워크가 연결된 경우 카메라를 다시 시작하십시오. · 빨간색 점멸: 카메라를 리셋한 다음 카메라를 다시 구성하십시오. · 빨간색 고정: 카메라에 문제가 있습니다.

KR

imou

Enjoy Smart Life



CE FC CCC UL  ISO 9001:2000

 @imouglobal

 service.global@imoulife.com

 www.imoulife.com