

**P12R-M
Series**

ASUS

Motherboard

E18697
First Edition
August 2021

Copyright © 2021 ASUSTeK COMPUTER INC. All Rights Reserved.

No part of this manual, including the products and software described in it, may be reproduced, transmitted, transcribed, stored in a retrieval system, or translated into any language in any form or by any means, except documentation kept by the purchaser for backup purposes, without the express written permission of ASUSTeK COMPUTER INC. ("ASUS").

Product warranty or service will not be extended if: (1) the product is repaired, modified or altered, unless such repair, modification of alteration is authorized in writing by ASUS; or (2) the serial number of the product is defaced or missing.

ASUS PROVIDES THIS MANUAL "AS IS" WITHOUT WARRANTY OF ANY KIND, EITHER EXPRESS OR IMPLIED, INCLUDING BUT NOT LIMITED TO THE IMPLIED WARRANTIES OR CONDITIONS OF MERCHANTABILITY OR FITNESS FOR A PARTICULAR PURPOSE. IN NO EVENT SHALL ASUS, ITS DIRECTORS, OFFICERS, EMPLOYEES OR AGENTS BE LIABLE FOR ANY INDIRECT, SPECIAL, INCIDENTAL, OR CONSEQUENTIAL DAMAGES (INCLUDING DAMAGES FOR LOSS OF PROFITS, LOSS OF BUSINESS, LOSS OF USE OR DATA, INTERRUPTION OF BUSINESS AND THE LIKE), EVEN IF ASUS HAS BEEN ADVISED OF THE POSSIBILITY OF SUCH DAMAGES ARISING FROM ANY DEFECT OR ERROR IN THIS MANUAL OR PRODUCT.

SPECIFICATIONS AND INFORMATION CONTAINED IN THIS MANUAL ARE FURNISHED FOR INFORMATIONAL USE ONLY, AND ARE SUBJECT TO CHANGE AT ANY TIME WITHOUT NOTICE, AND SHOULD NOT BE CONSTRUED AS A COMMITMENT BY ASUS. ASUS ASSUMES NO RESPONSIBILITY OR LIABILITY FOR ANY ERRORS OR INACCURACIES THAT MAY APPEAR IN THIS MANUAL, INCLUDING THE PRODUCTS AND SOFTWARE DESCRIBED IN IT.

Products and corporate names appearing in this manual may or may not be registered trademarks or copyrights of their respective companies, and are used only for identification or explanation and to the owners' benefit, without intent to infringe.

Contents

Safety information	vii
Electrical safety.....	vii
Operation safety.....	vii
P12R-M Series Specifications Summary	ix
Chapter 1: Product Introduction	
1.1 Welcome!	1-2
1.2 Package contents	1-2
1.3 Serial number label.....	1-3
1.4 Special features.....	1-3
1.4.1 Product highlights.....	1-3
1.4.2 Innovative ASUS features	1-5
Chapter 2: Hardware Information	
2.1 Before you proceed	2-2
2.2 Motherboard overview.....	2-3
2.2.1 Placement direction.....	2-3
2.2.2 Screw holes.....	2-3
2.2.3 Motherboard layout.....	2-5
2.2.4 Layout contents.....	2-7
2.3 Central Processing Unit (CPU)	2-9
2.3.1 Installing the CPU	2-9
2.3.2 Installing the CPU heatsink.....	2-12
2.3.3 Uninstalling the CPU heatsink and fan.....	2-13
2.3.4 Installing the CPU heatsink in rack	2-14
2.4 System memory	2-15
2.4.1 Overview	2-15
2.4.2 Memory configurations.....	2-15
2.4.3 Installing a DIMM	2-16
2.4.4 Removing a DIMM	2-16
2.5 Expansion slots.....	2-17
2.5.1 Installing an expansion card.....	2-17
2.5.2 Configuring an expansion card	2-17
2.5.3 Interrupt assignments.....	2-18
2.5.4 PCI Express x8 slot (x4 link)	2-19
2.5.5 PCI Express x16 slot (x16 link)	2-19
2.5.6 Installing the Baseboard Management Card.....	2-20
2.5.7 Installing an M.2 module	2-21
2.5.8 (optional) Installing the PFR module.....	2-22

Contents

- 2.6 Jumpers2-23
- 2.7 Onboard LEDs.....2-29
- 2.8 Connectors2-31
 - 2.8.1 Rear panel connectors.....2-31
 - 2.8.2 Internal connectors.....2-34

- Chapter 3: Powering Up**
- 3.1 Starting up for the first time.....3-2
- 3.2 Powering off the computer.....3-3
 - 3.2.1 Using the OS shut down function.....3-3
 - 3.2.2 Using the dual function power switch.....3-3

- Chapter 4: BIOS Setup**
- 4.1 Managing and updating your BIOS4-2
 - 4.1.1 ASUS CrashFree BIOS 3 utility.....4-2
 - 4.1.2 ASUS EzFlash Utility.....4-3
 - 4.1.3 BUPDATER utility4-4
- 4.2 BIOS setup program4-6
 - 4.2.1 BIOS menu screen.....4-7
 - 4.2.2 Menu bar.....4-7
 - 4.2.3 Menu items.....4-8
 - 4.2.4 Submenu items4-8
 - 4.2.5 Navigation keys.....4-8
 - 4.2.6 General help.....4-8
 - 4.2.7 Configuration fields4-8
 - 4.2.8 Pop-up window.....4-8
 - 4.2.9 Scroll bar4-8
- 4.3 Main menu4-9
 - 4.3.1 System Language [English]4-9
 - 4.3.2 System Date [Day xx/xx/xxxx].....4-9
 - 4.3.3 System Time [xx:xx:xx]4-9
- 4.4 Advanced menu4-10
 - 4.4.1 CPU Configuration4-11
 - 4.4.2 Power & Performance.....4-12
 - 4.4.3 Server ME Configuration.....4-15
 - 4.4.4 System Event Log.....4-16
 - 4.4.5 Trusted Computing.....4-17
 - 4.4.6 Redfish Host Interface Settings.....4-18
 - 4.4.7 Onboard LAN Configuration.....4-18

Contents

4.4.8	Serial Port Console Redirection	4-19
4.4.9	Intel TXT Information.....	4-22
4.4.10	SIO Configuration.....	4-22
4.4.11	PCI Subsystem Settings	4-23
4.4.12	USB Configuration	4-27
4.4.13	Network Stack Configuration.....	4-28
4.4.14	CSM (Compatibility Support Module).....	4-29
4.4.15	NVMe Configuration.....	4-31
4.4.16	APM Configuration	4-31
4.4.17	Third-party UEFI driver configurations	4-32
4.5	Chipset menu	4-33
4.5.1	System Agent (SA) Configuration	4-33
4.5.2	PCH Configuration	4-35
4.6	Security menu	4-39
4.7	Boot menu	4-43
4.8	Monitor menu	4-45
4.9	Tool menu.....	4-46
4.10	Event Logs menu	4-47
4.10.1	Change Smbios Event Log Settings	4-48
4.10.2	View Smbios Event Log	4-49
4.11	Server Mgmt menu.....	4-50
4.11.1	System Event Log.....	4-51
4.11.2	View FRU information	4-52
4.11.3	Bmc self test log.....	4-52
4.11.4	BMC network configuration.....	4-53
4.11.5	View System Event Log.....	4-54
4.12	Exit menu	4-55
 Chapter 5: RAID Configuration		
5.1	Setting up RAID.....	5-2
5.1.1	RAID definitions	5-2
5.1.2	Installing hard disk drives.....	5-3
5.1.3	Setting the RAID item in BIOS	5-3
5.2	Intel® Virtual Raid on CPU in BIOS.....	5-4
5.2.1	Creating a RAID set	5-5
5.2.2	Deleting a RAID set.....	5-6

Contents

- 5.3 Intel® Rapid Storage Technology enterprise (Windows)..... 5-7
 - 5.3.1 Creating a RAID set 5-8
 - 5.3.2 Changing a Volume Type..... 5-10
 - 5.3.3 Deleting a volume 5-11
 - 5.3.4 Preferences..... 5-12

Chapter 6: Driver Installation

- 6.1 RAID driver installation 6-2
 - 6.1.1 Creating a USB flash drive with RAID drive..... 6-2
 - 6.1.2 Installing the RAID controller driver..... 6-2
- 6.2 Running the Support DVD..... 6-5

Appendix

- P12R-M Series block diagram A-2
- Q-Code table A-3
- Notices A-5
- Service and Support A-9

Safety information

Electrical safety

- To prevent electrical shock hazard, disconnect the power cable from the electrical outlet before relocating the system.
- When adding or removing devices to or from the system, ensure that the power cables for the devices are unplugged before the signal cables are connected. If possible, disconnect all power cables from the existing system before you add a device.
- Before connecting or removing signal cables from the motherboard, ensure that all power cables are unplugged.
- Seek professional assistance before using an adapter or extension cord. These devices could interrupt the grounding circuit.
- Make sure that your power supply is set to the correct voltage in your area. If you are not sure about the voltage of the electrical outlet you are using, contact your local power company.
- If the power supply is broken, do not try to fix it by yourself. Contact a qualified service technician or your retailer.

Operation safety

- Before installing the motherboard and adding devices on it, carefully read all the manuals that came with the package.
- Before using the product, make sure all cables are correctly connected and the power cables are not damaged. If you detect any damage, contact your dealer immediately.
- To avoid short circuits, keep paper clips, screws, and staples away from connectors, slots, sockets and circuitry.
- Avoid dust, humidity, and temperature extremes. Do not place the product in any area where it may become wet.
- Place the product on a stable surface.
- If you encounter technical problems with the product, contact a qualified service technician or your retailer.

Conventions used in this guide

To ensure that you perform certain tasks properly, take note of the following symbols used throughout this manual.



DANGER/WARNING: Information to prevent injury to yourself when trying to complete a task.



CAUTION: Information to prevent damage to the components when trying to complete a task.



IMPORTANT: Instructions that you **MUST** follow to complete a task.



NOTE: Tips and additional information to help you complete a task.

Typography

Bold text

Indicates a menu or an item to select.

Italics

Used to emphasize a word or a phrase.

<Key>

Keys enclosed in the less-than and greater-than sign means that you must press the enclosed key.

Example: <Enter> means that you must press the Enter or Return key.

<Key1> + <Key2> + <Key3>

If you must press two or more keys simultaneously, the key names are linked with a plus sign (+).

Example: <Ctrl> + <Alt> +

Command

Means that you must type the command exactly as shown, then supply the required item or value enclosed in brackets.

Example: At DOS prompt, type the command line:

format A: /S

P12R-M Series Specifications Summary

		P12R-M	P12R-M/10G-2T
Processor Support / System Bus		1 x Socket H5 (LGA 1200) Intel® Xeon® E processor (up to 95W) Intel® Pentium™ processor	
Core Logic		Intel® C252 Chipset	
Form Factor		Micro ATX, 9.6 in. x 9.6 in.	
ASUS Features	Fan Speed Control	✓	
	Rack Ready (Rack and Pedestal dual use)	✓	
	ASUS Control Center	✓	
Memory	Total Slots	4 (2 Channels)	
	Voltage	1.2V	
	Capacity	Maximum up to 128GB	
	Memory Type	DDR4 3200/2933/2666 ECC UDIMM	
	Memory Size	32GB, 16GB, 8GB, 4GB	
Expansion Slots (follow SSI Location number)	Total PCI/PCI-E Slots	4	
	Slot Location 1	-	
	Slot Location 2	-	
	Slot Location 3	-	
	Slot Location 4	PCI-E x8 slot, x4 Gen4 Link	
	Slot Location 5	-	
	Slot Location 6	PCI-E x16 slot, x16 Gen4 Link	
Storage	SATA Controller	Intel® C252: 6 x SATA 6Gb/s ports Intel® VROC (Windows & Linux) (Support software RAID 0, 1, 10 & 5)	
	SAS Controller	Optional kits: ASUS PIKE II 3008 8-port SAS 12Gb/s HBA card ASUS PIKE II 3108 8-port SAS HW 12Gb/s RAID card Broadcom MegaRAID 9560-16i	
Networking	LAN	2 x Intel® I210-AT 1 x Mgmt LAN	1 x Intel® LOM X710-AT2 1 x Mgmt LAN
Graphic	VGA	Aspeed AST2600 64MB * VGA output from BMC	
	HDMI	HDMI 1.4 * HDMI output from CPU	

(continued on the next page)

		P12R-M	P12R-M/10G-2T
Onboard I/O Connectors	TPM Header	1	
	PSU Connector	24-pin ATX power connector 8-pin ATX 12V power connector	
	Management Header	Onboard header for optional management card	
	USB Connector/ Header	2 x USB 3.2 Gen 2 (rear), 1 x USB 3.2 Gen 2 (header, 2 ports), 1 x USB 2.0 (header, 2 ports)	
	Fan Header	6 x 4 pin headers	
	SMBus	1	
	Chassis Intruder	1	
	Front LAN LED	4	
	Serial Port Header	1	
	VGA Header	1	
	M.2 Connector	1	
Rear I/O Connectors	External USB Port	2 x USB 3.2 Gen 2 (rear)	
	VGA Port	1	
	RJ-45	2 x GbE LAN 1 x Mgmt LAN	2 x 10GbE LAN 1 x Mgmt LAN
Management Solution	Software	ASUS Control Center	
	Out of Band Remote Management	Optional ASMB10-iKVM for KVM-over-IP	
Monitoring	CPU Temperature	✓	
	FAN RPM	✓	
Environment	Operation temperature: 10°C ~ 50°C (50°F ~ 122°F) Non operation temperature: -40°C ~ 70°C (-40°F ~ 158°F) Non operation humidity: 20% ~ 90% (Non condensing)		



Specifications are subject to change without notice.

Product Introduction

1

This chapter describes the motherboard features and the new technologies it supports.

1.1 Welcome!

Thank you for buying an ASUS® P12R-M Series motherboard!

The motherboard delivers a host of new features and latest technologies, making it another standout in the long line of ASUS quality motherboards!

Before you start installing the motherboard and hardware devices on it, check the items in your package with the list below.

1.2 Package contents

Check your motherboard package for the following items.

Items		Standard Gift Box Pack	Standard Bulk Pack
I/O Shield		1	1
Cables	SATA 6G cable	3	--
	COM port cable	1	--
Application CD	Support DVD	1	1 pc per carton
Accessory	Metal Plate for LGA1200	1	1
Packaging Qty.		1 pc per carton	10 pcs per carton



If any of the above items is damaged or missing, contact your retailer.

1.3 Serial number label

Before requesting support from the ASUS Technical Support team, you must take note of the motherboard's serial number containing 12 characters **xxSxxxxxxxxx** shown as the figure below. With the correct serial number of the product, ASUS Technical Support team members can then offer a quicker and satisfying solution to your problems.



1.4 Special features

1.4.1 Product highlights

Latest processor technology

This motherboard supports the latest Intel® Xeon® Processor E-23xx / Pentium™ in LGA1200 package, which has memory and PCI Express controller integrated to support 2-channel (4 DIMMs) DDR4 memory and PCI Express 4.0 lanes. The Intel® Xeon® E-23xx have improve CPU performance and integrated voltage regulators making it one of the most powerful and energy efficient CPU in the world.

Integrated processor graphics support

This motherboard supports 1 digital display HDMI® with up to 4K resolution and integrated graphics Support will cover basic functionality that matches Client's level of features.

DMI Speed 3.0 x8

Improvement for a significant upgrade over traditional 3.0 x4.

Intel® Turbo Boost

Intel® Turbo Boost automatically allows the processor to run faster than the marked frequency if the processor is operating below its power, current, and temperature specification limits. This technology increases performance of both multi-threaded and single-threaded workloads.

Intel® Hyper Threading

The thread-level parallelism on each processor makes more efficient use of the processor resources, higher processing throughout and improved performance on today's multi-threaded software.

Intel® EM64T

The motherboard supports Intel® processors with the Intel® EM64T (Extended Memory 64 Technology). The Intel® EM64T feature allows your computer to run on 64-bit operating systems and access larger amounts of system memory for faster and more efficient computing.

DDR4 memory support

The motherboard supports DDR4 memory that features faster clock frequencies and higher data transfer rates of 3200 MT/s (million transfers per second). DDR4 offers a lower voltage standard of 1.2V that reduces memory power demand and provides improved performance.

PCI Express 4.0

PCI Express® (PCIe+) 4.0 delivers 16 GT/s bandwidth, which is double the speed of PCIe 3.0, offering lower power consumption, better lane scalability and backwards compatibility. P12R-M series are PCIe 4.0 ready to support a diverse array of graphics, storage and networking – enabling flexible scalability for demanding or increasing workloads.

PCI Express 3.0

PCI Express 3.0 (PCIe 3.0) is the PCI Express bus standard that provides twice the performance and speed of PCIe 2.0. It provides an optimal graphics performance, unprecedented data speed, and seamless transition with its complete backward compatibility to PCIe 1.0/2.0 devices.

Intel® I210AT LAN Solution

The motherboard comes with two Gigabit LAN controllers and ports which provide a total solution for your networking needs. The onboard Intel® I210AT Gigabit LAN controllers use the PCI Express interface and could achieve network throughput close to Gigabit bandwidth.

Intel® 10G LAN Solution

Dual Intel® 10G LAN offers increased data throughput and improved efficiency, making it ideal for large file transfers and backup. Featuring dual onboard 10G LAN ported by the cutting-edge Intel® LOM X710AT2 Ethernet Controller, P12R-M/10G-2T provides server-grade connectivity and supports high-density, high-bandwidth, low-latency access-layer networks to ensure faster transfers of large-size files used in data-intensive applications.

Enhanced Intel SpeedStep Technology (EIST)

The Enhanced Intel SpeedStep Technology (EIST) intelligently manages the CPU resources by automatically adjusting the CPU voltage and core frequency depending on the CPU loading and system speed or power requirement.

Serial ATA III technology

The motherboard supports the Serial ATA III 6 Gb/s technology through the Serial ATA interface and Intel® C252 chipset. Get enhanced scalability, faster data retrieval, double the bandwidth of current bus systems with up to 6Gbps data transfer rates.

USB 3.2 Gen 1 (5Gbps) / Gen 2 (10Gbps) technology

The motherboard implements the USB 3.2 Gen 1 / Gen 2 technology with data transfer speeds of up to 5Gbps or 10Gbps, faster charging time for USB-chargeable devices, optimized power efficiency, and backward compatibility with USB 2.0.

Temperature, fan, and voltage monitoring

The CPU temperature is monitored to prevent overheating and damage. The system fan rotations per minute (RPM) is monitored for timely failure detection. The chip monitors the voltage levels to ensure stable supply of current for critical components.

1.4.2 Innovative ASUS features

ASUS Fan Speed technology

The ASUS Fan Speed technology smartly adjusts the fan speeds according to the system loading to ensure quiet, cool, and efficient operation.

Hardware Information

2

This chapter lists the hardware setup procedures that you have to perform when installing system components. It includes description of the jumpers and connectors on the motherboard.

2.1 Before you proceed

Take note of the following precautions before you install motherboard components or change any motherboard settings.



- Unplug the power cord from the wall socket before touching any component.
 - Use a grounded wrist strap or touch a safely grounded object or a metal object, such as the power supply case, before handling components to avoid damaging them due to static electricity.
 - Hold components by the edges to avoid touching the ICs on them.
 - Whenever you uninstall any component, place it on a grounded antistatic pad or in the bag that came with the component.
 - Before you install or remove any component, ensure that the power supply is switched off or the power cord is detached from the power supply. Failure to do so may cause severe damage to the motherboard, peripherals, and/or components.
-

2.2 Motherboard overview

Before you install the motherboard, study the configuration of your chassis to ensure that the motherboard fits into it.

To optimize the motherboard features, we highly recommend that you install it in an ATX 2.2 compliant chassis.



Ensure to unplug the chassis power cord before installing or removing the motherboard. Failure to do so can cause you physical injury and damage motherboard components!

2.2.1 Placement direction

When installing the motherboard, ensure that you place it into the chassis in the correct orientation. The edge with external ports goes to the rear part of the chassis as indicated in the image below.

2.2.2 Screw holes

Place eight (8) screws into the holes indicated by circles to secure the motherboard to the chassis.



DO NOT overtighten the screws! Doing so can damage the motherboard.

P12R-M

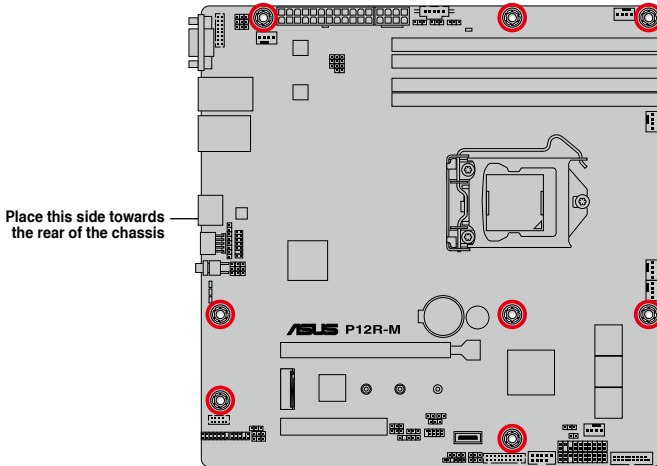

P12R-M/10G-2T

Place this side towards
the rear of the chassis

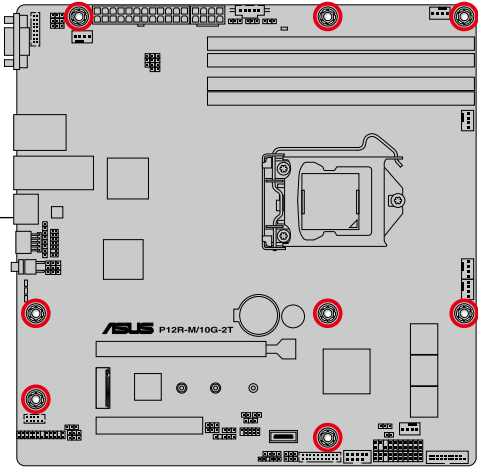

2.2.3 Motherboard layout

P12R-M

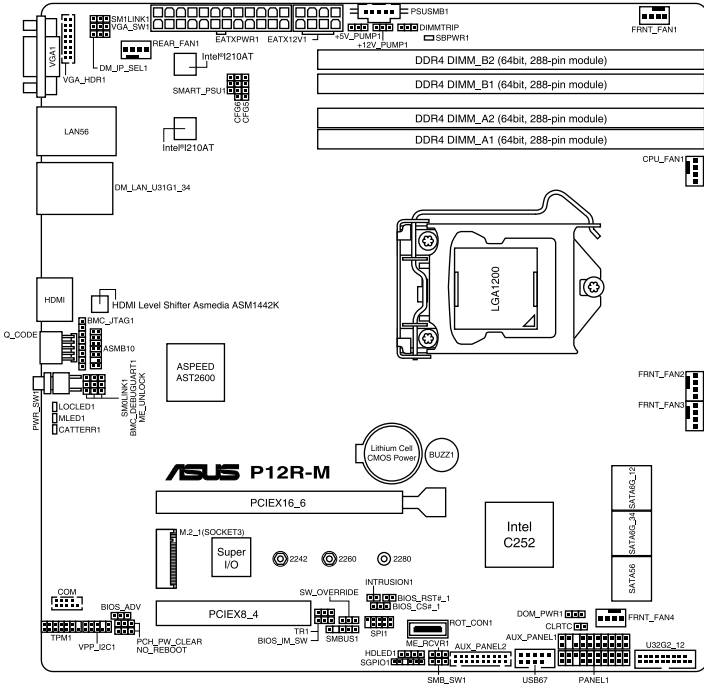

P12R-M/10G-2T

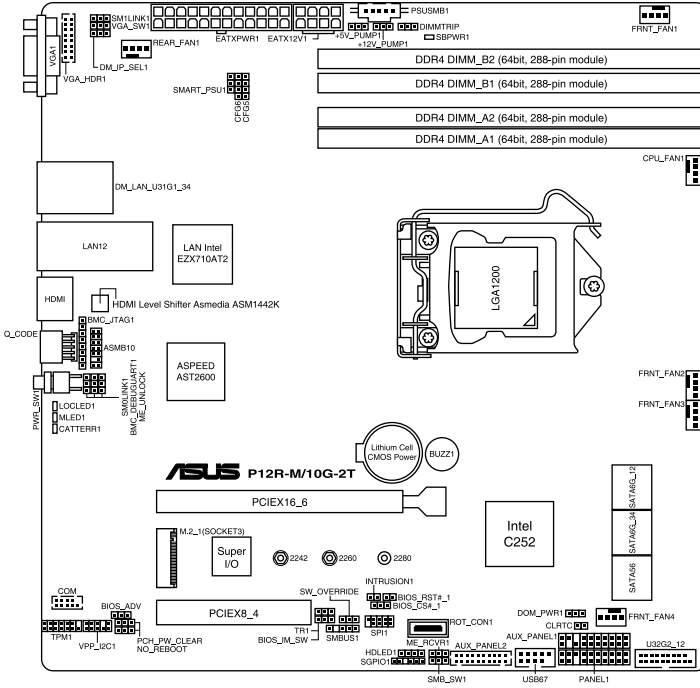

2.2.4 Layout contents

Slots/Sockets		Page
1.	CPU socket	2-9
2.	DDR4 sockets	2-15
3.	PCI Express x16 / PCI Express x8	2-19

Jumpers		Page
1.	Clear RTC RAM (2-pin CLRRTC)	2-23
2.	VGA controller setting (3-pin VGA_SW1)	2-24
3.	DDR4 Thermal Event jumper (3-pin DIMMTRIP2)	2-24
4.	ME firmware force recovery setting (3-pin ME_RCVR1)	2-25
5.	Smart Ride Through (SmaRT) setting (3-pin SMART_PSU1)	2-25
6.	DMLAN setting (3-pin DM_IP_SEL1)	2-26
7.	SATADOM power setting (3-pin DOM_PWR1)	2-26
8.	CPU PCIE configuration setting (4-pin CFG5-6)	2-27
9.	PCIe SMBus Switcher setting (3-pin SMB_SW1)	2-28

Onboard LEDs		Page
1.	Standby Power LED (SBPWR1)	2-29
2.	CATT ERR LED (CATTERR1)	2-29
3.	Location LED (LOCLED1)	2-30
4.	Message LED (MLED1)	2-30

Rear panel connectors (P12R-M)		Page
1.	Video Graphics Adapter port	2-31
2.	RJ-45 ports for Intel® I210 LAN 1-2	2-31
3.	RJ-45 port for iKVM	2-31
4.	USB 3.2 Gen 2 ports 1 and 2	2-31
5.	HDMI™ port	2-31
6.	Q-Code LED	2-31
7.	Power-on Button	2-31

Rear panel connectors (P12R-M/10G-2T)		Page
1.	Video Graphics Adapter port	2-32
2.	RJ-45 port for iKVM	2-32
3.	USB 3.2 Gen 2 ports 1 and 2	2-32
4.	RJ-45 ports for Intel® LOM X710AT LAN 1-2	2-32
5.	HDMI™ port	2-32
6.	Q-Code LED	2-32
7.	Power-on Button	2-32

Internal connectors		Page
1.	Serial ATA 6.0 Gbp/s connectors (7-pin SATA6G_1-4; SATA5-6)	2-34
2.	Hard disk activity LED connector (4-pin HDLED1)	2-34
3.	Serial General Purpose Input/Output connector (6-1 pin SGPIO1)	2-35
4.	USB 2.0 connectors (10-1 pin USB67)	2-35
5.	USB 3.2 Gen 2 connector (20-1 pin USB3_34)	2-36
6.	VGA connector (16-pin VGA_HDR1)	2-36
7.	Trusted Platform Module connector (14-1 pin TPM1)	2-37
8.	Fan connectors (4-pin CPU_FAN1, FRNT_FAN1-4, REAR_FAN1)	2-37
9.	Serial port connector (10-1 pin COM1)	2-38
10.	Power Supply SMBus connector (5-pin PSUSMB1)	2-38
11.	ATX power connectors (24-pin EATXPWR1, 8-pin EATX12V1)	2-39
12.	System panel connector (20-1 pin PANEL1)	2-40
13.	Auxiliary panel connectors (20-2 pin AUX_PANEL1; 20-pin AUX_PANEL2)	2-41
14.	Chassis intrusion connector (2-pin INTRUSION)	2-42
15.	System Management Bus (SMBUS) connector (5-1 pin SMBUS1)	2-42
16.	Thermal sensor cable connector (3-pin TR1)	2-43
17.	VPP_I2C connector (10-1 pin VPP_I2C1)	2-43
18.	BMC connector (14-1 pin ASMB10)	2-20
19.	M.2 slot (NGFF1-2)	2-21
20.	PFR module connector (ROT_CON1)	2-22

2.3 Central Processing Unit (CPU)

The motherboard comes with a surface mount LGA1200 socket designed for the Intel® Xeon® E processor (up to 95W) and Intel® Pentium™ processors.



- Upon purchase of the motherboard, ensure that the PnP cap is on the socket and the socket contacts are not bent. Contact your retailer immediately if the PnP cap is missing, or if you see any damage to the PnP cap/socket contacts/motherboard components. ASUS will shoulder the cost of repair only if the damage is shipment/transit-related.
- The product warranty does not cover damage to the socket contacts resulting from incorrect CPU installation/removal, or misplacement/loss/incorrect removal of the PnP cap.



The motherboard illustration is for reference only. The location for the CPU socket is the same for all motherboards of this series.

2.3.1 Installing the CPU

To install the CPU:

1. Locate the CPU socket on the motherboard.

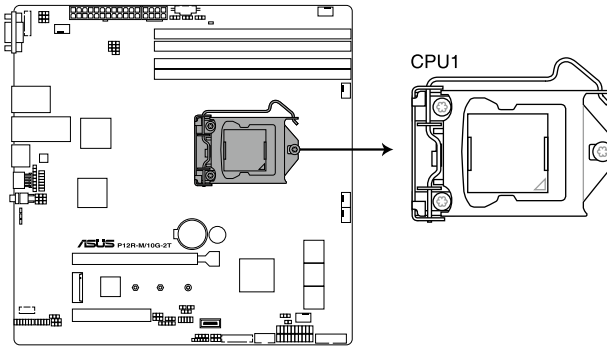

P12R-M/ 10G-2T CPU LGA1200



Before installing the CPU, ensure that the socket box is facing toward you and the load lever is on your right.

2. Press the load lever with your thumb (A), then move it to the right (B) until it is released from the retention tab.



Do not remove the PnP cap yet from the CPU socket. Doing so may bend the pins of the socket.

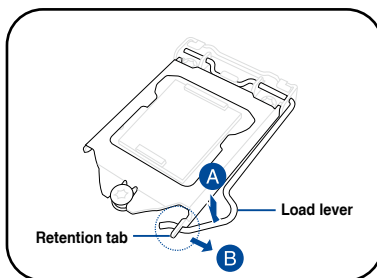

3. Lift the load plate.

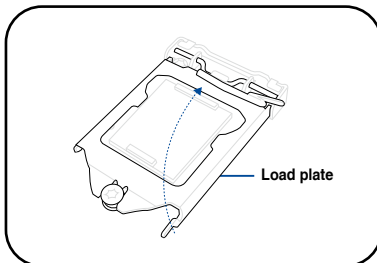

4. Remove the PnP cap from the CPU socket.

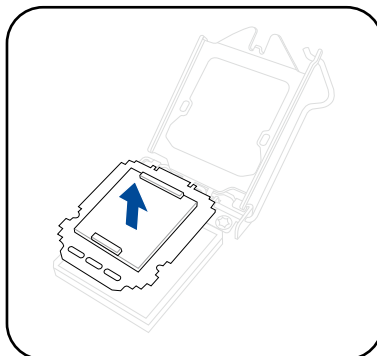

5. Position the CPU above the socket, ensuring that the gold triangle mark is on the bottom-left corner of the socket, then fit the CPU notches to the socket's alignment keys.



The CPU fits in only one orientation. DO NOT force the CPU into the socket to prevent bending the pins on the socket and damaging the CPU.

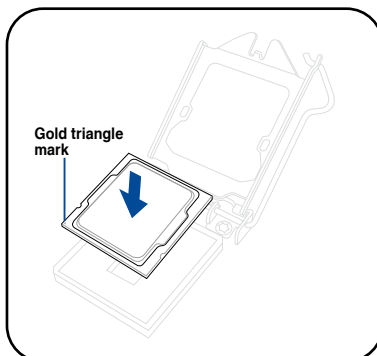

6. Close the load plate (A), ensuring that the front edge of the load plate slides under the retention lock (B).

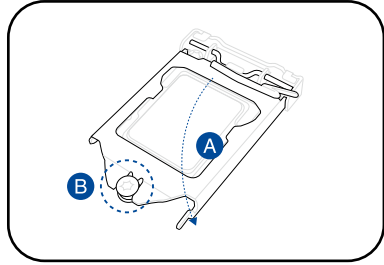

7. Push the load lever down and insert it under the retention tab to secure the CPU in the socket.

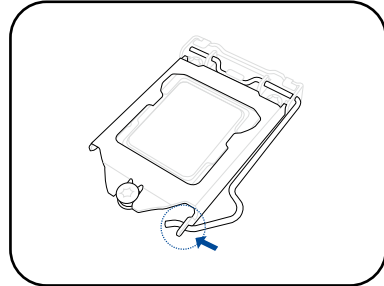

8. Apply some Thermal Interface Material to the exposed area of the CPU that the heatsink will be in contact with, ensuring that it is evenly spread in a thin layer.



Some heatsinks come with pre-applied Thermal Interface Material. If so, skip this step.



The Thermal Interface Material is toxic and inedible. DO NOT eat it. If it gets into your eyes or touches your skin, wash it off immediately and seek professional medical help.

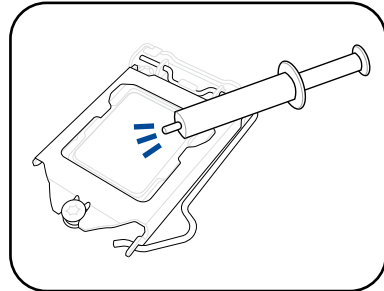

2.3.2 Installing the CPU heatsink

The Intel® LGA1200 processor requires a specially designed CPU heatsink to ensure optimum thermal condition and performance.



- When you buy a boxed Intel® processor, a specially designed CPU heatsink or a CPU heatsink with a CPU fan assembly is included depending on the package. If you buy a CPU separately, ensure that you use only Intel® certified multi-directional CPU heatsink or CPU heatsink with CPU fan.
- Use an LGA1200-compatible CPU heatsink and CPU fan assembly only. The LGA1200 socket is incompatible with the LGA775 and LGA1366 sockets in size and dimension.



If you purchased a separate CPU heatsink and fan assembly, ensure that the Thermal Interface Material is properly applied to the CPU heatsink or CPU before you install the heatsink and fan assembly.



Ensure that you have installed the motherboard to the chassis before you install the CPU fan and heatsink assembly.

To install the CPU heatsink and fan:

1. Place the heatsink on top of the installed CPU, making sure that the four fasteners match the holes on the motherboard.
2. Push down two fasteners at a time in a diagonal sequence to secure the heatsink and fan assembly in place.

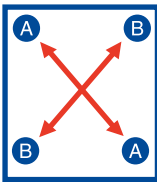
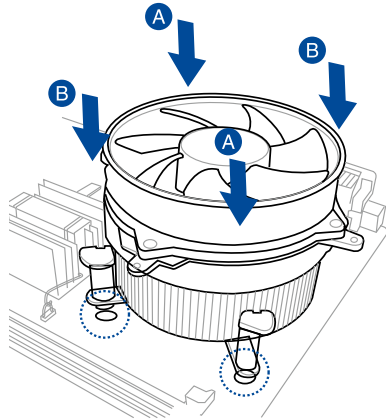

Orient the heatsink and fan assembly such that the CPU fan cable is closest to the CPU fan connector.

3. Connect the CPU fan cable to the connector on the motherboard labeled CPU_FAN1.

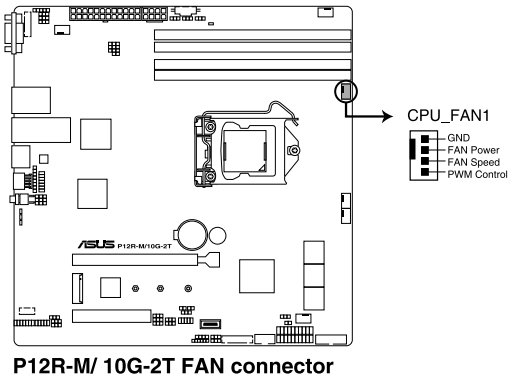

DO NOT forget to connect the CPU fan connector! Hardware monitoring errors can occur if you fail to plug this connector.

2.3.3 Uninstalling the CPU heatsink and fan

To uninstall the CPU heatsink and fan:

1. Disconnect the CPU fan cable from the connector on the motherboard.
2. Rotate each fastener counterclockwise.
3. Pull up two fasteners at a time in a diagonal sequence to disengage the heatsink and fan assembly from the motherboard.

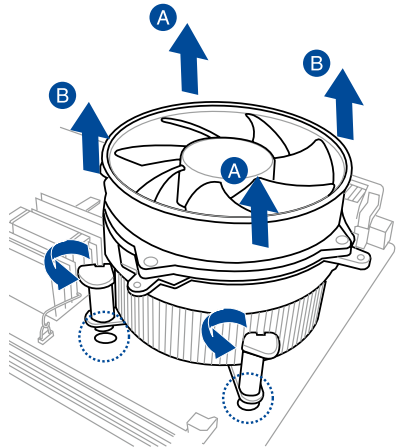
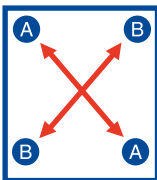

4. Carefully remove the heatsink and fan assembly from the motherboard.

2.3.4 Installing the CPU heatsink in rack

The Intel® LGA1200 processor requires a specially designed heatsink to ensure optimum thermal condition and performance.



- Ensure that you use qualified heatsink assembly only.
- Ensure that you have applied the thermal interface material to the top of the CPU before installing the heatsink and fan.

1. Peel off the sticker on the heatsink metal plate and affix the plate to the back of the motherboard, matching the standoffs to the heatsink screw holes.

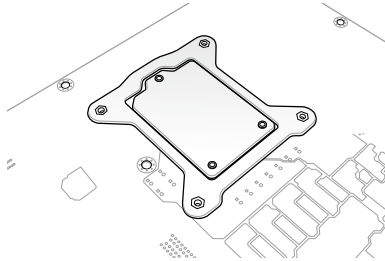

2. Use a Phillips screwdriver to tighten the four heatsink screws using the recommended sequence below.

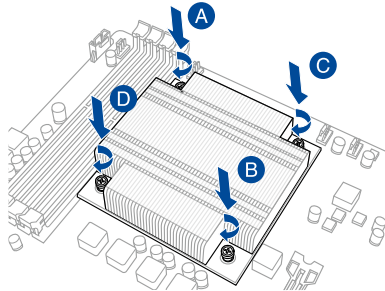
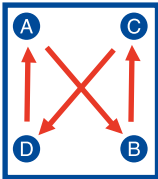

- Ensure that the heatsink is not skewed or tilted, otherwise the CPU will overheat.
- Do not overtighten the screws. Doing so can damage the CPU.

2.4 System memory

2.4.1 Overview

The motherboard comes with four (4) Double Data Rate 4 (DDR4) Dual Inline Memory Modules (DIMM) sockets.



A DDR4 module is notched differently from a DDR, DDR2, or DDR3 module. DO NOT install a DDR, DDR2, or DDR3 memory module to the DDR4 slot.

The figure illustrates the location of the DDR4 DIMM sockets:

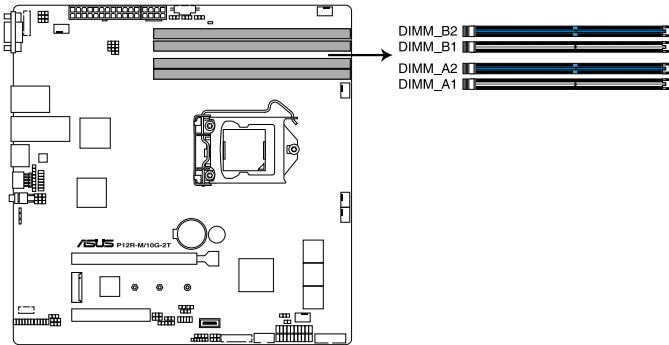

P12R-M/ 10G-2T 288-pin DDR4 DIMM sockets

2.4.2 Memory configurations

You may install unbuffered DDR4 DIMMs into the DIMM sockets using the memory configurations in this section.

UDIMM				
DIMM Slot Per Channel	DIMM Populated per Channel	DIMM Type	Speed	Rank per DIMM
2	1	Unbuffered DDR4	3200	Single Rank, Dual Rank
2	2	Unbuffered DDR4	3200	Single Rank, Dual Rank



- Always install DIMMs with the same CAS latency. For optimum compatibility, it is recommended that you obtain memory modules from the same vendor.
- Start installing the DIMMs in slots A2 and B2 (Blue).

2.4.3 Installing a DIMM



Ensure to unplug the power supply before adding or removing DIMMs or other system components. Failure to do so may cause severe damage to both the motherboard and the components.

1. Unlock a DIMM socket by pressing the retaining clips outward.
2. Align a DIMM on the socket such that the notch on the DIMM matches the DIMM slot key on the socket.

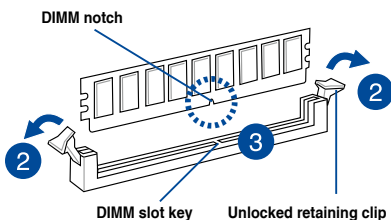

A DIMM is keyed with a notch so that it fits in only one direction. **DO NOT** force a DIMM into a socket in the wrong direction to avoid damaging the DIMM.

3. Hold the DIMM by both of its ends then insert the DIMM vertically into the socket. Apply force to both ends of the DIMM simultaneously until the retaining clips snaps back into place.

Ensure that the DIMM is sitting firmly on the DIMM slot.

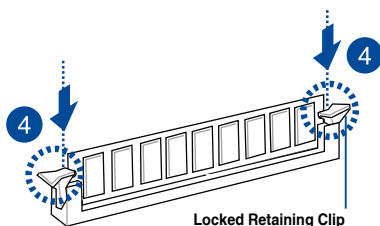

Always insert the DIMM into the socket **VERTICALLY** to prevent DIMM notch damage.

2.4.4 Removing a DIMM

1. Remove the chassis cover. For more information, see the section **Chassis cover**.
2. Simultaneously press the retaining clips outward to unlock the DIMM.
3. Remove the DIMM from the socket.

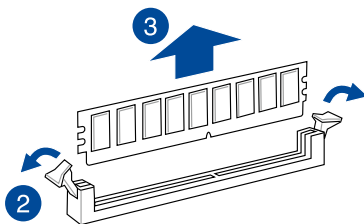

Support the DIMM lightly with your fingers when pressing the retaining clips. The DIMM might get damaged when it flips out with extra force.

2.5 Expansion slots

In the future, you may need to install expansion cards. The following subsections describe the slots and the expansion cards that they support.



Ensure to unplug the power cord before adding or removing expansion cards. Failure to do so may cause you physical injury and damage motherboard components.

2.5.1 Installing an expansion card

To install an expansion card:

1. Before installing the expansion card, read the documentation that came with it and make the necessary hardware settings for the card.
2. Remove the system unit cover (if your motherboard is already installed in a chassis).
3. Remove the bracket opposite the slot that you intend to use. Keep the screw for later use.
4. Align the card connector with the slot and press firmly until the card is completely seated on the slot.
5. Secure the card to the chassis with the screw you removed earlier.
6. Replace the system cover.

2.5.2 Configuring an expansion card

After installing the expansion card, configure it by adjusting the software settings.

1. Turn on the system and change the necessary BIOS settings, if any. See Chapter 4 for information on BIOS setup.
2. Assign an IRQ to the card. Refer to the tables on the next page.
3. Install the software drivers for the expansion card.



When using PCI cards on shared slots, ensure that the drivers support "Share IRQ" or that the cards do not need IRQ assignments. Otherwise, conflicts will arise between the two PCI groups, making the system unstable and the card inoperable.

2.5.3 Interrupt assignments

Standard Interrupt assignments

IRQ	Priority	Standard function
0	1	System Timer
1	-	-
2	-	Programmable Interrupt
3	4	Communications Port (COM2)
4	5	Communications Port (COM1)
5	-	-
6	-	-
7	-	-
8	-	-
9	-	-
10	-	-
11	-	-
12	-	-
13	2	Numeric Data Processor
14	3	Intel® GPIO Controller
15	-	-

2.5.4 PCI Express x8 slot (x4 link)

The onboard PCIeX8_4 provide one x4 Gen4 link to the PCH. These slots support various server class high performance add-on cards.

2.5.5 PCI Express x16 slot (x16 link)

The onboard PCIeX16_6 provides one x16 Gen4 link to CPU. This slot supports VGA cards and various server class high performance add-on cards.

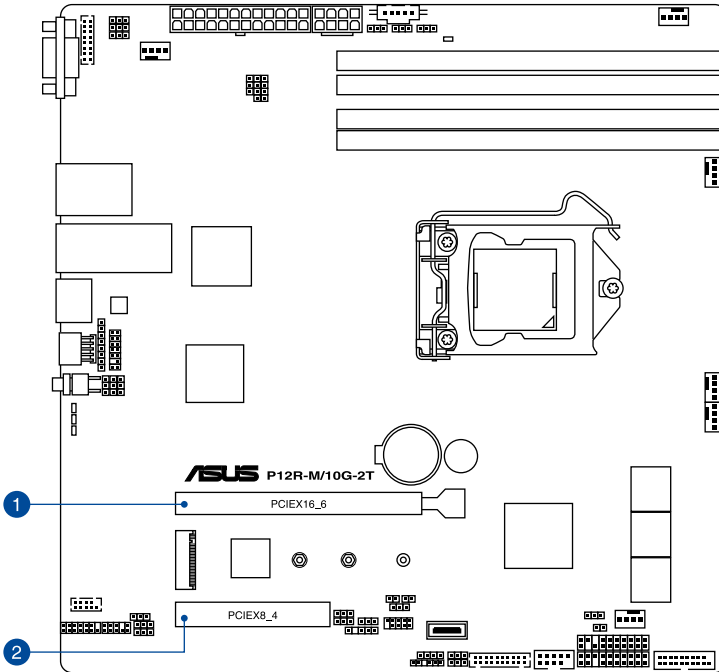

No.(Slot location)	Short Description	
1 (slot 6)	PCIEX16_6	1 x PCI-E x16 (x16 Gen4 link)
2 (slot 4)	PCIEX8_4	1 x PCI-E x8 (x4 Gen4 Link)

2.5.6 Installing the Baseboard Management Card

Follow the steps below to install an optional ASMB10 Management Card on your motherboard.



The motherboard illustration is for reference only. The motherboard layout and appearance may vary depending on the model, but the installation steps remain the same.

1. Locate the Baseboard Management Card header on the motherboard.

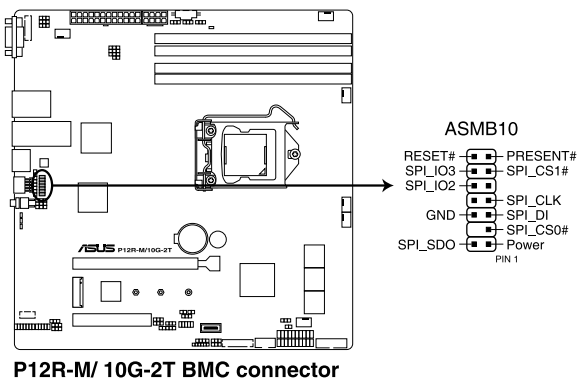

2. Orient and press the Management Card in place.

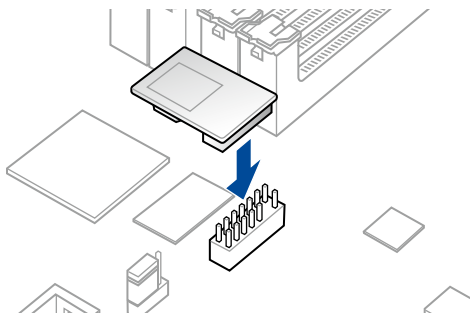

2.5.7 Installing an M.2 module

You may install an M.2 card (supports up to 2280) to the onboard M.2 slot on the motherboard.



This connector supports type 2242 / 2260 / 2280 devices on PCIe Gen 3 x4 interface.



- The M.2 (NGFF) device is purchased separately.
- The motherboard illustration is for reference only. The motherboard layout and appearance may vary depending on the model, but the installation steps remain the same.

1. Locate the M.2 slot (M.2_1(SOCKET3)) on the motherboard.

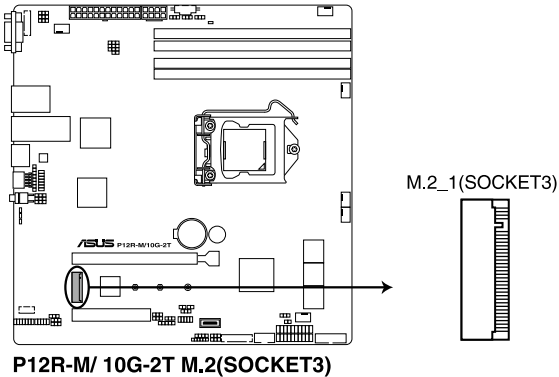

2. Remove the screw on the stand screw.
3. (optional) Remove the stand screw if you wish to install a 2242 or 2260 length M.2 module.
4. (optional) Install the stand screw to the length hole corresponding to the M.2 module you wish to install.
5. Prepare the M.2 module, then align and insert the M.2 module into the M.2 slot (M.2_1(SOCKET3)).
6. Secure the M.2 module with the screw you removed in step 2.

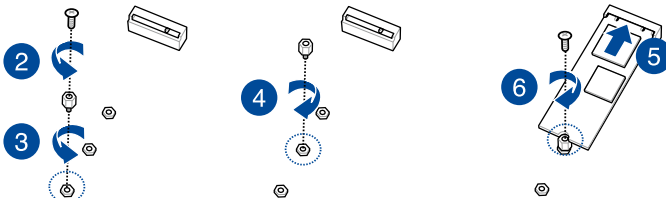

2.5.8 (optional) Installing the PFR module

The optional PFR module will come pre-installed on your system and is connected to the PFR module connector on your motherboard.



- The illustration below is for reference only.
- For more information or assistance, please refer to www.asus.com.

1. Locate the PFR module connector on your motherboard.

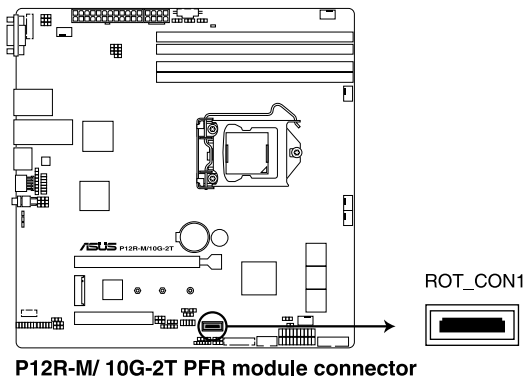

2. Align and connect the PFR module to the PFR module connector.

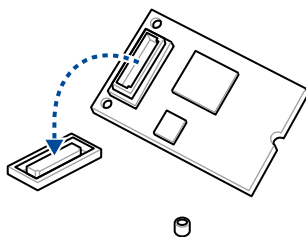

3. Push the PFR module down so that it is seated securely on the PFR module connector, then secure it using a screw.

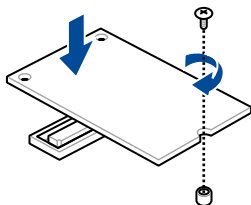

2.6 Jumpers



The motherboard illustration is for reference only. The motherboard layout and appearance may vary depending on the model, but the locations for these jumpers/LEDs/connectors remain the same.

1. Clear RTC RAM (2-pin CLRRTC)

This jumper allows you to clear the CMOS memory system setup parameters by erasing the CMOS Real Time Clock (RTC) RAM data. The onboard button cell battery powers the RAM data in CMOS, which include system setup information such as system passwords.

To erase the RTC RAM:

1. Turn OFF the computer and unplug the power cord.
2. Short-circuit pin 1-2 with a metal object or jumper cap for about 5-10 seconds.
3. Plug the power cord and turn ON the computer.
4. Hold down the key during the boot process and enter BIOS setup to re-enter data.



DO NOT short-circuit the pins except when clearing the RTC RAM. Short-circuiting or placing a jumper cap will cause system boot failure!



- If the steps above do not help, remove the onboard battery and short the two pins again to clear the CMOS RTC RAM data. After clearing the CMOS, reinstall the battery.
- Due to chipset behavior, AC power off is required to enable C.P.R. function. You must turn off and on the power supply or unplug and plug the power cord before rebooting the system.

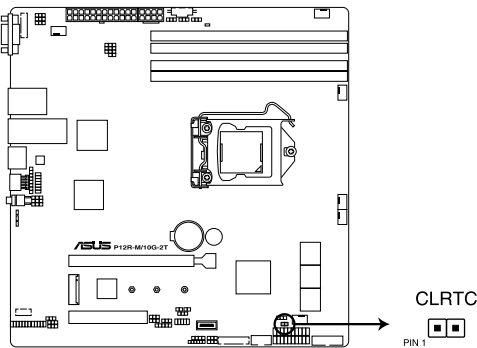

P12R-M/ 10G-2T Clear RTC RAM

2. VGA controller setting (3-pin VGA_SW1)

This jumper allows you to enable or disable the onboard VGA controller. Set to pins 1–2 to activate the VGA feature.

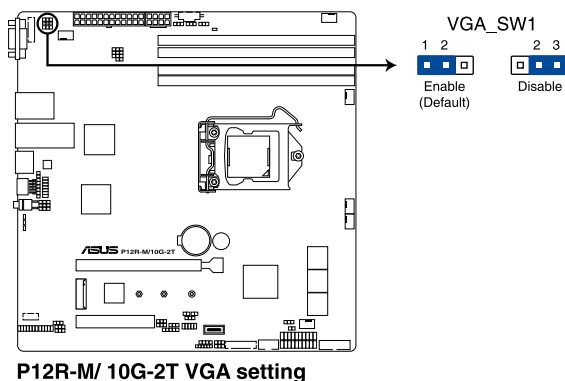

3. DDR4 Thermal Event jumper (3-pin DIMMTRIP2)

Set to pins 1-2 to enable DDR4 DIMM thermal sensing event.

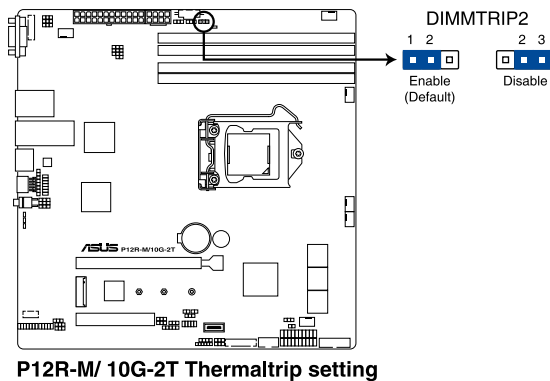

4. ME firmware force recovery setting (3-pin ME_RCVR1)

This jumper allows you to force Intel Management Engine (ME) boot from recovery mode when ME become corrupted.

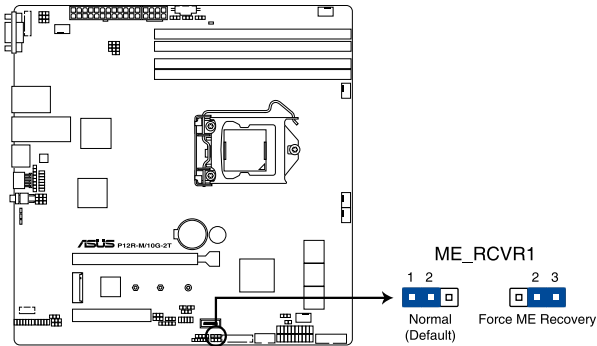

P12R-M/ 10G-2T ME recovery setting

5. Smart Ride Through (SmaRT) setting (3-pin SMART_PSU1)

This jumper allows you to enable or disable the Smart Ride Through (SmaRT) function. This feature is disabled by default. Set to pins 1-2 to enable it. When enabled, SmaRT allows uninterrupted operation of the system during an AC loss event.

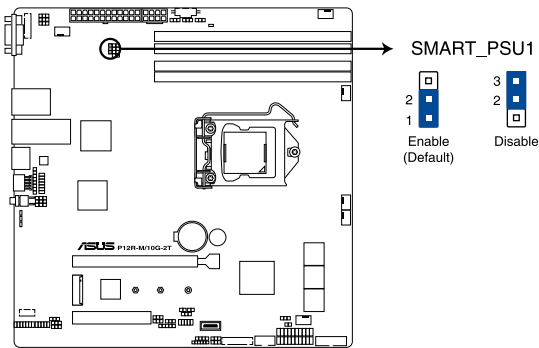

P12R-M/ 10G-2T Smart Ride Through setting

6. DMLAN setting (3-pin DM_IP_SEL1)

This jumper allows you to select the DMLAN setting. Set to pins 2-3 to force the DMLAN IP to static mode (IP=10.10.10.10, submask=255.255.255.0).

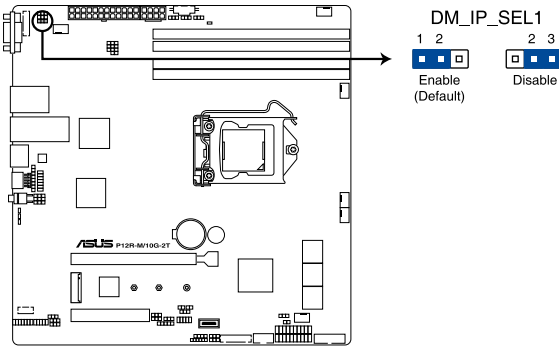

P12R-M/ 10G-2T DM_IP_SEL1 setting

7. SATADOM power setting (3-pin DOM_PWR1)

This jumper allows SATA56 to support SATADOM which do not need external power connections. Set to pins 2-3 to activate the SATA56 support feature.

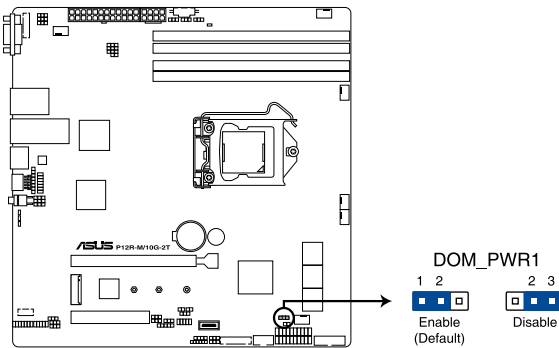

P12R-M/ 10G-2T DOM_PWR1 setting

8. CPU PCIe configuration setting (4-pin CFG5-6)

These jumpers allow you to configure the speed at which PCIEX16_6 will run at. Refer to the table below for the different jumper configurations.

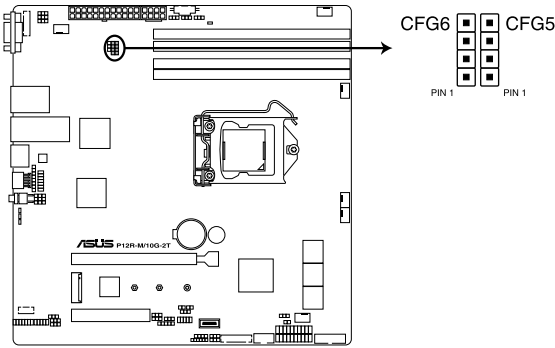

P12R-M/ 10G-2T CFG6 & CFG5 connectors

Jumper Setting		
CFG6	CFG5	PCIEX16_6 slot configuration
1 2 	1 2 	Riser card (default)
2 3 	2 3 	x16
2 3 	3 4 	x8, x8
3 4 	3 4 	x8, x4, x4

9. PCIe SMBus Switcher setting (3-pin SMB_SW1)

This jumper allows toggle whether the SMBUS signal comes from BMC or PCH.

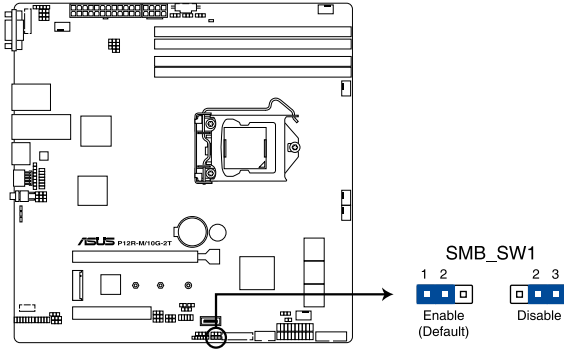

P12R-M/ 10G-2T SMBus Switcher setting

2.7 Onboard LEDs



The motherboard illustration is for reference only. The motherboard layout and appearance may vary depending on the model, but the locations for these jumpers/LEDs/connectors remain the same.

1. Standby Power LED (SBPWR1)

The motherboard comes with a standby power LED. The green LED lights up to indicate that the system is ON, in S5 mode. This is a reminder that you should shut down the system and unplug the power cable before removing or plugging in any motherboard component. The illustration below shows the location of the onboard LED.

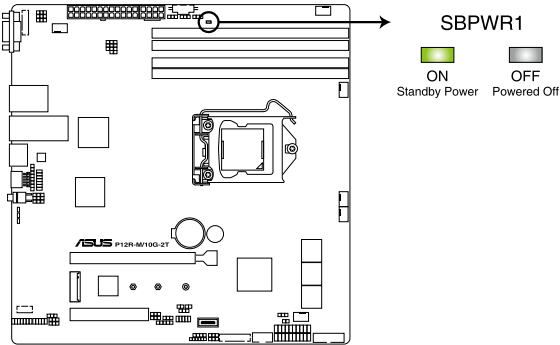

P12R-M/ 10G-2T Standby Power LED

2. CATT ERR LED (CATTERR1)

The CATT ERR LED indicates that the system has experienced a fatal or catastrophic error and cannot continue to operate.

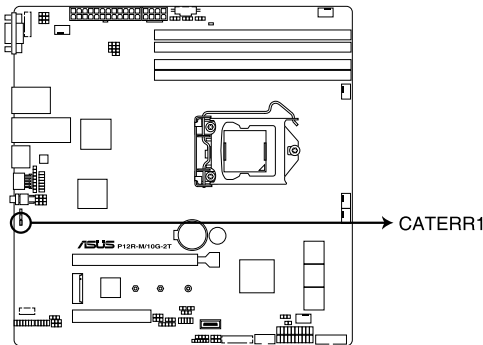

P12R-M/ 10G-2T CATTERR1

3. Location LED (LOCLED1)

This onboard LED lights up when the Location button on the server is pressed or when triggered by a system management software. The Location LED helps visually locate and quickly identify the server in error on a server rack.

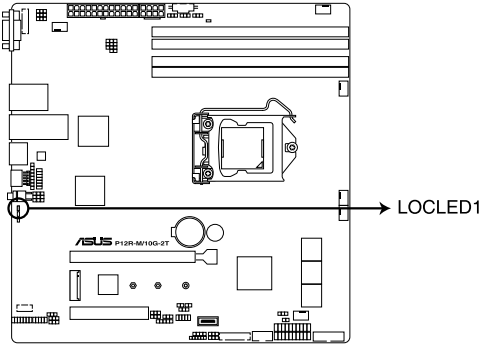

P12R-M/ 10G-2T Location LED

4. Message LED (MLED1)

This onboard LED lights up to indicate that there is a temperature warning or a BMC event log is generated.

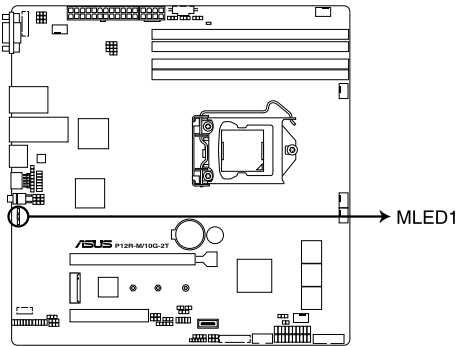

P12R-M/ 10G-2T MLED

2.8 Connectors

2.8.1 Rear panel connectors

P12R-M

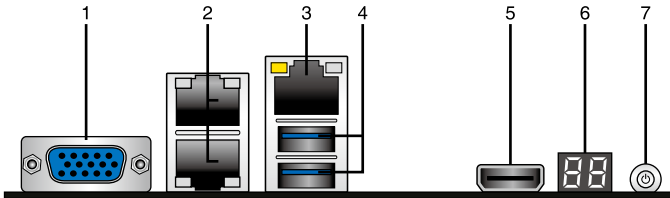

1. **Video Graphics Adapter port.** This port is for a VGA monitor or other VGA-compatible devices.
2. **RJ-45 ports for Intel® I210 LAN 1-2.** These ports allow Gigabit connection to a Local Area Network (LAN) through a network hub. Refer to the table below for the LAN port LED indications.
3. **RJ-45 port for iKVM.** This RJ-45 port functions only when you enable ASMB10 Management card.
4. **USB 3.2 Gen 2 ports 1 and 2.** These two 4-pin USB ports are available for connecting USB 3.2 Gen 2 devices.
5. **HDMI™ port.** The HDMI™ (High Definition Multimedia Interface) port supports a Full-HD device such as an LCD TV or monitor to allow viewing on a larger external display.
6. **Q-Code LED:** The Q-Code LED provides a 2-digit display that shows the status of your system. Refer to the **Q-Code table** of this user guide for more information about the 2-digit codes.
7. **Power-on Button:** Press this button to turn on the system.

P12R-M/10G-2T

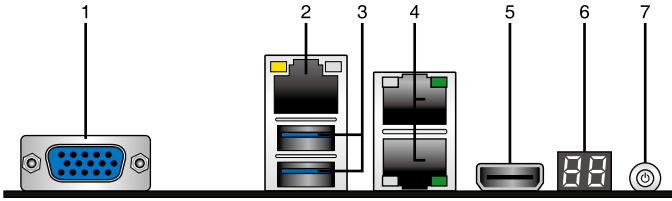

1. **Video Graphics Adapter port.** This port is for a VGA monitor or other VGA-compatible devices.
2. **RJ-45 port for iKVM.** This RJ-45 port functions only when you enable ASMB10 Management card.
3. **USB 3.2 Gen 2 ports 1 and 2.** These two 4-pin USB ports are available for connecting USB 3.2 Gen 2 devices.
4. **RJ-45 ports for Intel® LOM X710AT LAN 1-2.** These ports allows Gigabit connection to a Local Area Network (LAN) through a network hub. Refer to the table below for the LAN port LED indications.
5. **HDMI™ port.** The HDMI™ (High Definition Multimedia Interface) port supports a Full-HD device such as an LCD TV or monitor to allow viewing on a larger external display.
6. **Q-Code LED:** The Q-Code LED provides a 2-digit display that shows the status of your system. Refer to the **Q-Code table** of this user guide for more information about the 2-digit codes.
7. **Power-on Button:** Press this button to turn on the system.

Intel® I210 LAN port LED indications

Activity/Link LED	
Status	Description
OFF	No link
GREEN	Linked
BLINKING	Data activity

Speed LED	
Status	Description
OFF	10 Mbps connection
ORANGE	100 Mbps connection
GREEN	1 Gbps connection

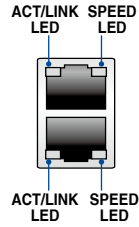

Intel® LOM X710AT LAN port LED indications

Activity/Link LED	
Status	Description
OFF	No link
GREEN	Linked
BLINKING	Data activity

Speed LED	
Status	Description
OFF	100 Mbps connection
ORANGE	1 Gbps connection
GREEN	10 Gbps connection

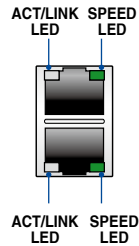

Dedicated Management LAN port (DM_LAN1) LED indications

Activity/Link LED	
Status	Description
OFF	No link
YELLOW	Linked
BLINKING	Data activity

Speed LED	
Status	Description
OFF	10 Mbps connection
ORANGE	100 Mbps connection
GREEN	1 Gbps connection

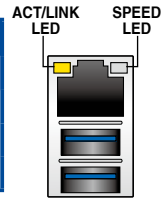

2.8.2 Internal connectors

1. Serial ATA 6.0 Gbp/s connectors (7-pin SATA6G_1-4; SATA5-6)

Supported by the Intel® C252 chipset, these connectors are for the Serial ATA signal cables for Serial ATA hard disk drives that allows up to 6Gb/s of data transfer rate.

If you installed Serial ATA hard disk drives, you can create a RAID 0, RAID 1, RAID 10, or RAID 5 configuration.

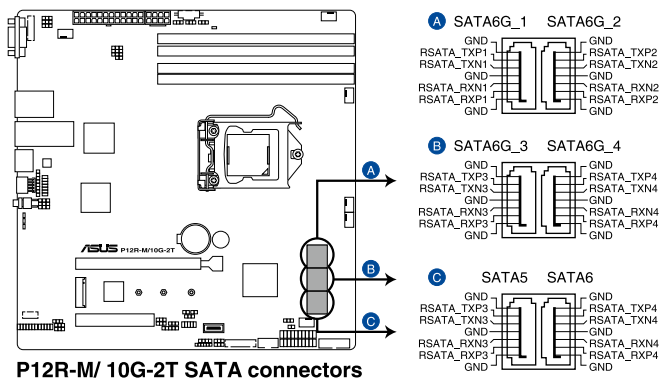

The actual data transfer rate depends on the speed of Serial ATA hard disks installed.

2. Hard disk activity LED connector (4-pin HDLED1)

This LED connector is for the storage add-on card cable connected to the SATA or SAS add-on card. The read or write activities of any device connected to the SATA or SAS add-on card causes the front panel LED to light up.

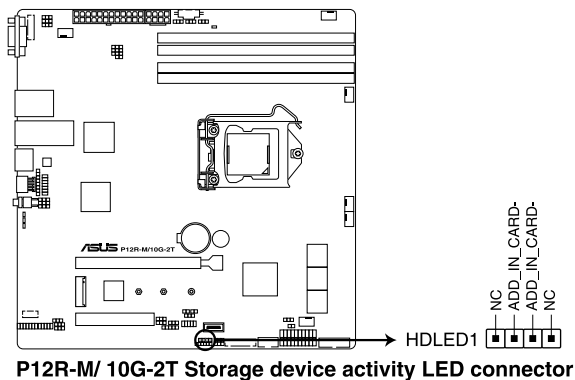

3. Serial General Purpose Input/Output connector (6-1 pin SGPIO1)

The SGPIO 1 connector is used for the Intel Rapid Storage Technology Enterprise SGPIO interface that controls the LED pattern generation, device information, and general purpose data.

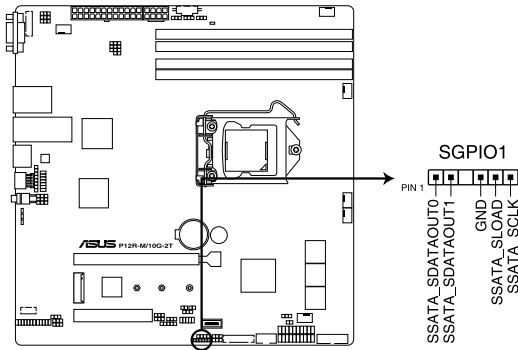

P12R-M/ 10G-2T Serial General Purpose Input/Output connector



DO NOT connect a 1394 cable to the USB connectors. Doing so will damage the motherboard!

4. USB 2.0 connectors (10-1 pin USB67)

This connector allows you to connect a USB 2.0 module for additional USB 2.0 front or rear panel ports. This USB connector provides data transfer speeds of up to 480 Mb/s connection speed.

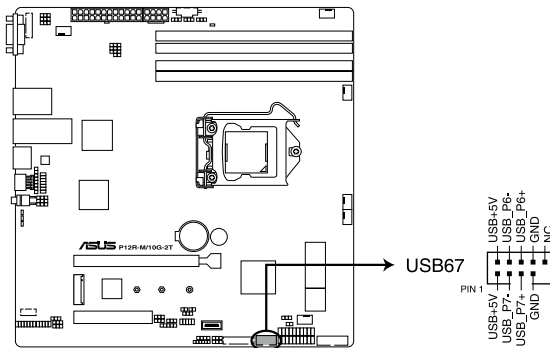

P12R-M/ 10G-2T USB 2.0 connector

5. USB 3.2 Gen 2 connector (20-pin USB3_34)

This connector allows you to connect a USB 3.2 Gen 2 module for additional USB 3.2 Gen 2 front or rear panel ports. The USB 3.2 Gen 2 connector provides data transfer speeds of up to 10 Gb/s.

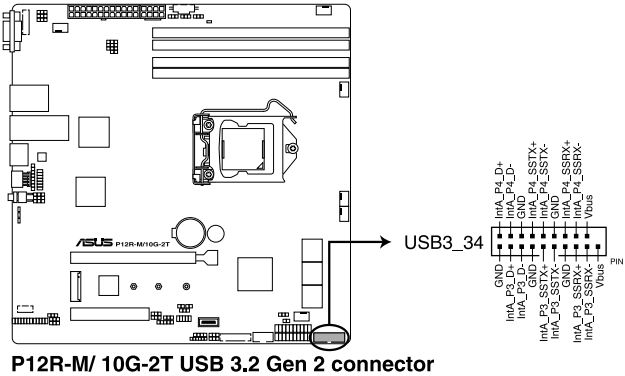

P12R-M/ 10G-2T USB 3.2 Gen 2 connector



The USB 3.2 Gen 2 module is purchased separately.



The plugged USB 3.2 Gen 2 device may run on xHCI or EHCI mode depending on the operating system's setting.

6. VGA connector (16-pin VGA_HDR1)

This connector supports the VGA High Dynamic-Range interface.

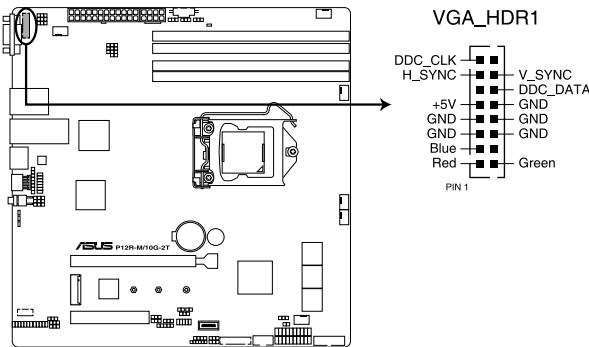

P12R-M/ 10G-2T Internal VGA connector

7. Trusted Platform Module connector (14-1 pin TPM1)

This connector supports a Trusted Platform Module (TPM) system, which can securely store keys, digital certificates, passwords, and data. A TPM system also helps enhance network security, protects digital identities, and ensures platform integrity.

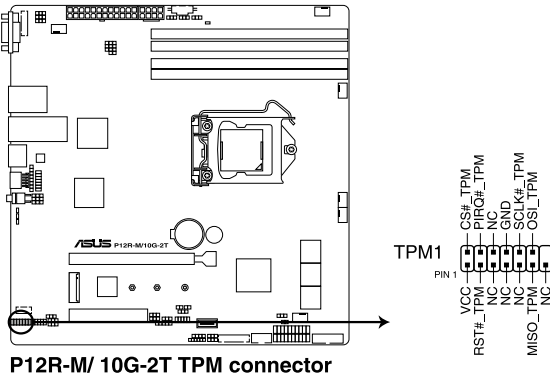

8. Fan connectors (4-pin CPU_FAN1, FRNT_FAN1-4, REAR_FAN1)

The fan connectors support cooling fans. Connect the fan cables to the fan connectors on the motherboard, ensuring that the black wire of each cable matches the ground pin of the connector.

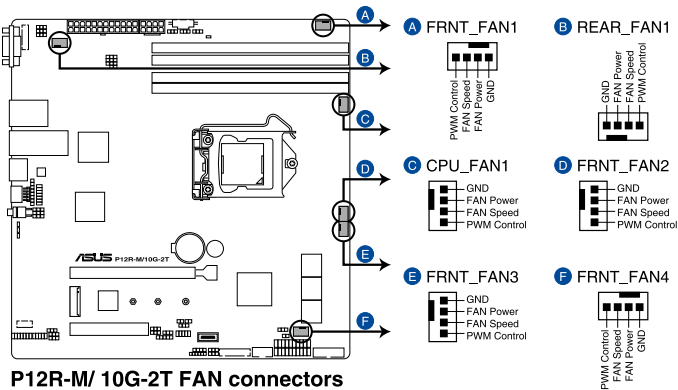

- DO NOT forget to connect the fan cables to the fan connectors. Insufficient air flow inside the system may damage the motherboard components.
- These are not jumpers! DO NOT place jumper caps on the fan connectors!
- All fans feature the ASUS Smart Fan technology.

9. Serial port connector (10-1 pin COM1)

These connectors are for the serial (COM) ports. Connect the serial port module cable to the connector, then install the module to a slot opening at the back of the system chassis.

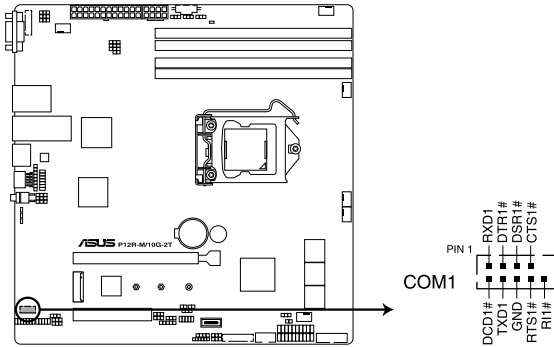

P12R-M/ 10G-2T Serial port connector



The COM module is purchased separately.

10. Power Supply SMBus connector (5-pin PSUSMB1)

This connector allows you to connect SMBus (System Management Bus) to the PSU (power supply unit) to read PSU information. Devices communicate with an SMBus host and/or other SMBus devices using the SMBus interface.

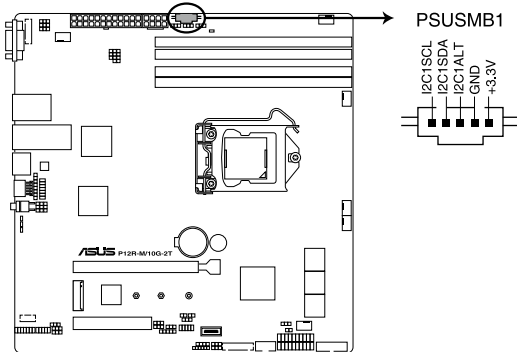

P12R-M/ 10G-2T Power supply SMBus connector



This connector functions only when you enable the ASUS ASMB10.



Power supply is required to meet PMBus specification and customized BMC FW may be needed. Please contact ASUS if you need further support.

11. ATX power connectors (24-pin EATXPWR1, 8-pin EATX12V1)

These connectors are for the ATX power supply plugs. The power supply plugs are designed to fit these connectors in only one orientation. Find the proper orientation and push down firmly until the connectors completely fit.

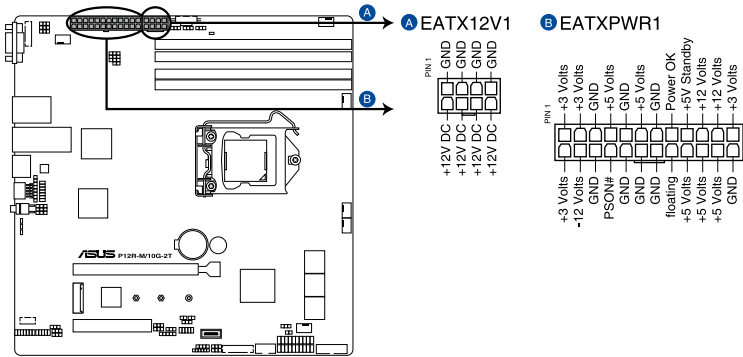

P12R-M/ 10G-2T ATX power connectors



- DO NOT forget to connect the 24-pin and the 8-pin power plugs; otherwise, the system will not boot up.
- Use of a power supply unit (PSU) with a higher power output is recommended when configuring a system with more power-consuming devices. The system may become unstable or may not boot up if the power is inadequate.
- This motherboard supports ATX2.0 PSU or later version.
- Ensure that your PSU can provide at least the minimum power required by your system.

12. System panel connector (20-1 pin PANEL1)

This connector supports several chassis-mounted functions.

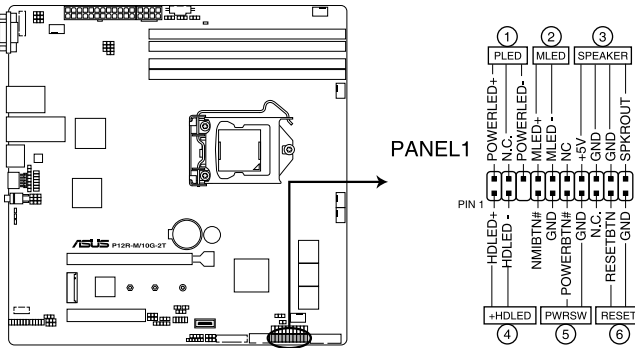

P12R-M/ 10G-2T System panel connector

- **System power LED (3-pin PLED)**

This 3-pin connector is for the system power LED. Connect the chassis power LED cable to this connector. The system power LED lights up when you turn on the system power, and blinks when the system is in sleep mode.

- **Message LED (2-pin MLED)**

This 2-pin connector is for the message LED cable that connects to the front message LED. The message LED is controlled by Hardware monitor to indicate an abnormal event occurrence.

- **System warning speaker (4-pin SPEAKER)**

This 4-pin connector is for the chassis-mounted system warning speaker. The speaker allows you to hear system beeps and warnings.

- **Hard disk drive activity LED (2-pin +HLED)**

This 2-pin connector is for the HDD Activity LED. Connect the HDD Activity LED cable to this connector. The IDE LED lights up or flashes when data is read from or written to the HDD.

- **Power button/soft-off button (2-pin PWRSW)**

This connector is for the system power button. Pressing the power button turns the system on or puts the system in sleep or soft-off mode depending on the BIOS settings. Pressing the power switch for more than four (4) seconds while the system is ON turns the system OFF.

- **Reset button (2-pin RESET)**

This 2-pin connector is for the chassis-mounted reset button for system reboot without turning off the system power.

13. Auxiliary panel connectors (20-2 pin AUX_PANEL1; 20-pin AUX_PANEL2)

These connectors are for additional front panel features including front panel SMB, locator LED and switch, chassis intrusion, and LAN LEDs.

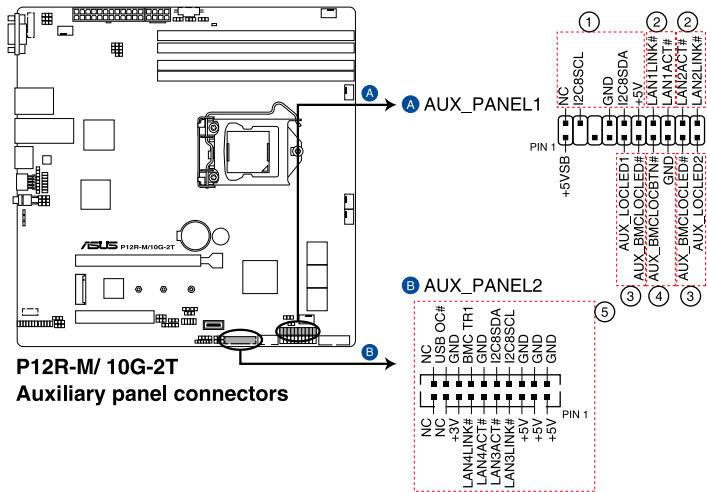

- Front panel SMB (6-1 pin FPSMB)**
 This 6-1 pin connector is for the front panel SMBus cable.
- LAN activity LED (2-pin LAN1_LED, LAN2_LED)**
 This 2-pin connector is for the Gigabit LAN activity LEDs on the front panel.
- Locator LED (2-pin LOCATORLED1, 2-pin LOCATORLED2)**
 This 2-pin connector is for the locator LED1 and LED2 on the front panel. Connect the Locator LED cables to these 2-pin connector. The LEDs will light up when the Locator button is pressed.
- Locator Button/Switch (2-pin LOCATORBTN)**
 This 2-pin connector is for the locator button on the front panel. This button queries the state of the system locator.
- LAN activity LED and USB port (2-pin LAN3_LED, LAN4_LED, USB ports)**
 These leads are for the Gigabit LAN activity LEDs and USB ports on the front panel.

14. Chassis intrusion connector (2-pin INTRUSION)

This connector is for a chassis-mounted intrusion detection sensor or switch. Connect one end of the chassis intrusion sensor or switch cable to this connector. The chassis intrusion sensor or switch sends a high-level signal to this connector when a chassis component is removed or replaced. The signal is then generated as a chassis intrusion event.

By default, the pin labeled “Chassis Signal” and “Ground” are shorted with a jumper cap. Remove the jumper caps only when you intend to use the chassis intrusion detection feature.

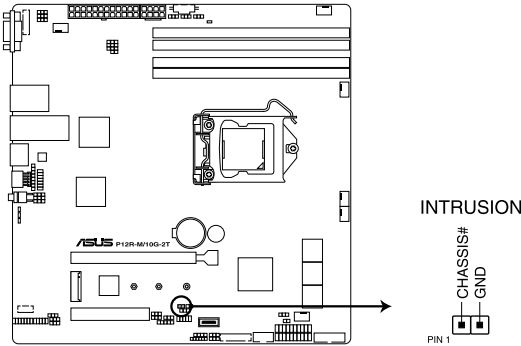

P12R-M/ 10G-2T Chassis Intrusion connector

15. System Management Bus (SMBUS) connector (5-1 pin SMBUS1)

This connector controls the system and power management-related tasks. This connector processes the messages to and from devices rather than tripping the individual control lines.

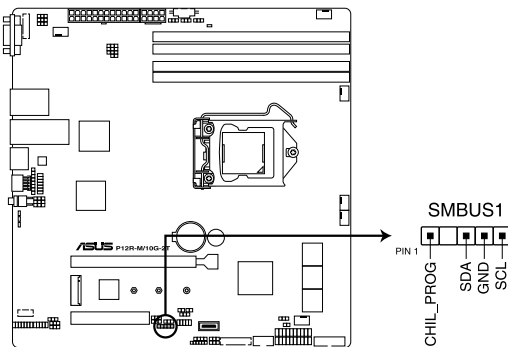

P12R-M/ 10G-2T SMBUS connector

16. Thermal sensor cable connector (3-pin TR1)

This connector allows you to connect a thermal sensor cable that is used for monitoring temperature. Connect the thermal sensor cable to the connector and place its probe to the device that you want to monitor.

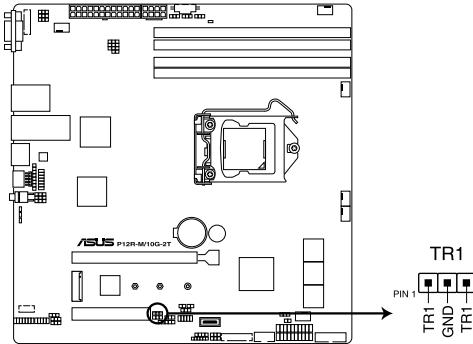

P12R-M/ 10G-2T Thermal sensor cable connector

17. VPP_I2C connector (10-1 pin VPP_I2C1)

The VPP_I2C connector is used for the storage backplane with sensor readings.

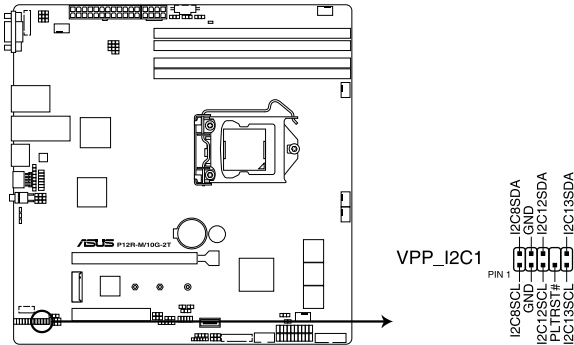

P12R-M/ 10G-2T VPP_I2C1 connector

Powering Up

3

This chapter describes the power up sequence, and ways of shutting down the system.

3.1 Starting up for the first time

1. After making all the connections, replace the system case cover.
2. Be sure that all switches are off.
3. Connect the power cord to the power connector at the back of the system chassis.
4. Connect the power cord to a power outlet that is equipped with a surge protector.
5. Turn on the devices in the following order:
 - a. Monitor
 - b. External storage devices (starting with the last device on the chain)
 - c. System power
6. After applying power, the system power LED on the system front panel case lights up. For systems with ATX power supplies, the system LED lights up when you press the ATX power button. If your monitor complies with “green” standards or if it has a “power standby” feature, the monitor LED may light up or switch between orange and green after the system LED turns on.

The system then runs the power-on self-test or POST. While the tests are running, the BIOS beeps or additional messages appear on the screen. If you do not see anything within 30 seconds from the time you turned on the power, the system may have failed a power-on test. Check the jumper settings and connections or call your retailer for assistance.

The following shows the possible beep codes and its corresponding error condition

BIOS Beep codes	
Beep	Error condition
1 short	Power supply surges detected during the previous power on.
1 short	No Keyboard Detected.
1 short, 2 short	No DIMM Detected.
1 short, 8 short	No VGA Detected.
2 long	Chassis Intrusion.
2 long	BIOS-image Crash Detected.

7. At power on, hold down the key to enter the BIOS Setup. Follow the instructions in Chapter 4.

3.2 Powering off the computer

3.2.1 Using the OS shut down function

Using Windows® Server 2019:

1. Press <Ctrl>+<Alt>+.
2. Click on the Power icon on the lower right side of the screen.
3. Select **Shut down**.
4. In the Shutdown Event Tracker, select the **Other (Planned)** option in the selection lists. Otherwise, select the option that best describes why you want to shut down the computer.
5. Click **Continue**.

3.2.2 Using the dual function power switch

While the system is ON, press the power switch for less than four seconds to put the system to sleep mode or to soft-off mode, depending on the BIOS setting.



Pressing the power switch for more than four seconds lets the system enter the soft-off mode regardless of the BIOS setting.

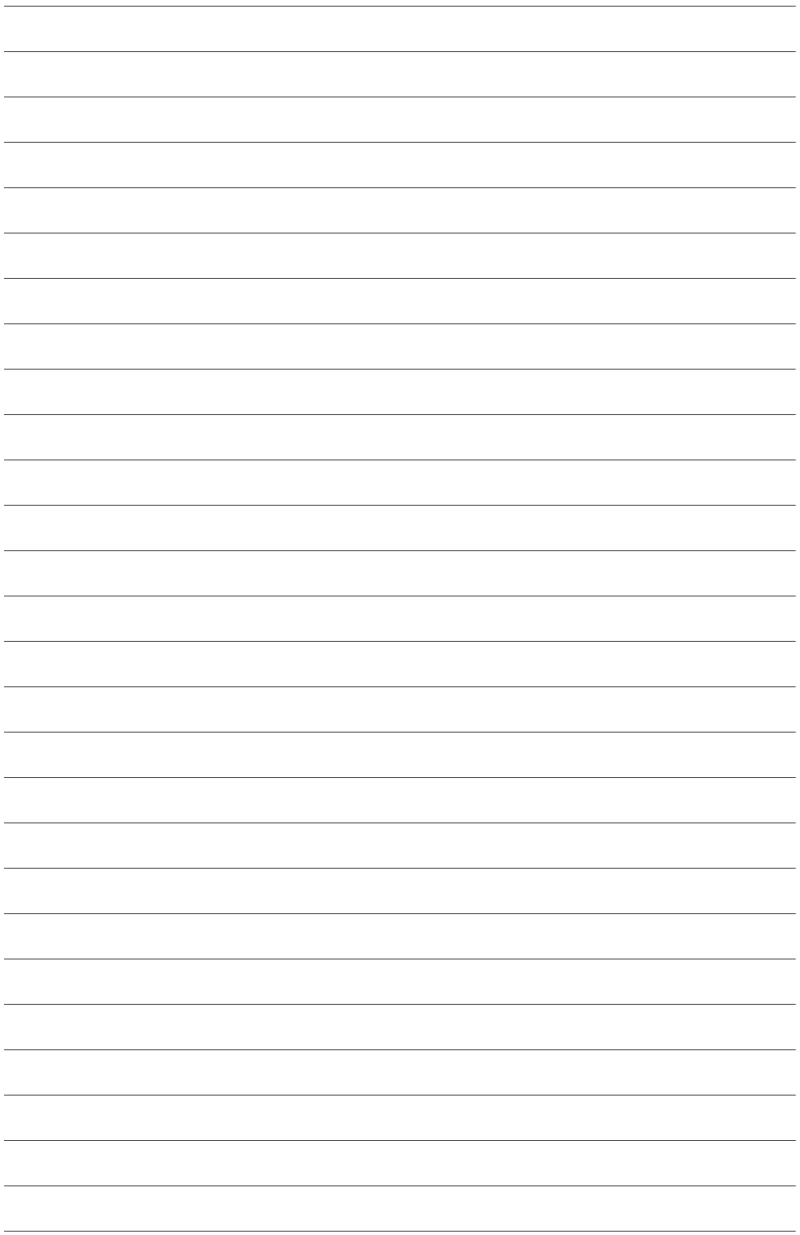

BIOS Setup

4

This chapter tells how to change the system settings through the BIOS Setup menus. Detailed descriptions of the BIOS parameters are also provided.

4.1 Managing and updating your BIOS

The following utilities allow you to manage and update the motherboard Basic Input/Output System (BIOS) setup:

1. **ASUS CrashFree BIOS 3**

To recover the BIOS using a bootable USB flash disk drive when the BIOS file fails or gets corrupted.

2. **ASUS EzFlash**

Updates the BIOS using a USB flash disk.

3. **BUPDATER**

Updates the BIOS in DOS mode using a bootable USB flash disk drive.

Refer to the corresponding sections for details on these utilities.



Save a copy of the original motherboard BIOS file to a bootable USB flash disk drive in case you need to restore the BIOS in the future. Copy the original motherboard BIOS using the BUPDATER utility.

4.1.1 **ASUS CrashFree BIOS 3 utility**

The ASUS CrashFree BIOS 3 is an auto recovery tool that allows you to restore the BIOS file when it fails or gets corrupted during the updating process. You can update a corrupted BIOS file using a USB flash drive that contains the updated BIOS file.



Prepare a USB flash drive containing the updated motherboard BIOS before using this utility.



When downloading or updating the BIOS file, rename it as **P11CM4L.CAP** for this motherboard.

Recovering the BIOS from a USB flash drive

To recover the BIOS from a USB flash drive:

1. Insert the USB flash drive with the original or updated BIOS file to one USB port on the system.
2. The utility will automatically recover the BIOS. It resets the system when the BIOS recovery finished.



DO NOT shut down or reset the system while recovering the BIOS! Doing so would cause system boot failure!



The recovered BIOS may not be the latest BIOS version for this motherboard. Visit the ASUS website at www.asus.com to download the latest BIOS file.

4.1.2 ASUS EzFlash Utility

The ASUS EzFlash Utility feature allows you to update the BIOS using a USB flash disk without having to use a DOS-based utility.



Download the latest BIOS from the ASUS website at www.asus.com before using this utility.



The succeeding BIOS screens are for reference only. The actual BIOS screen displays may not be the same as shown.

To update the BIOS using EzFlash Utility:

1. Insert the USB flash disk that contains the latest BIOS file to the USB port.
2. Enter the BIOS setup program. Go to the **Tool** menu to select **Start EzFlash** and press <Enter> to enable it.

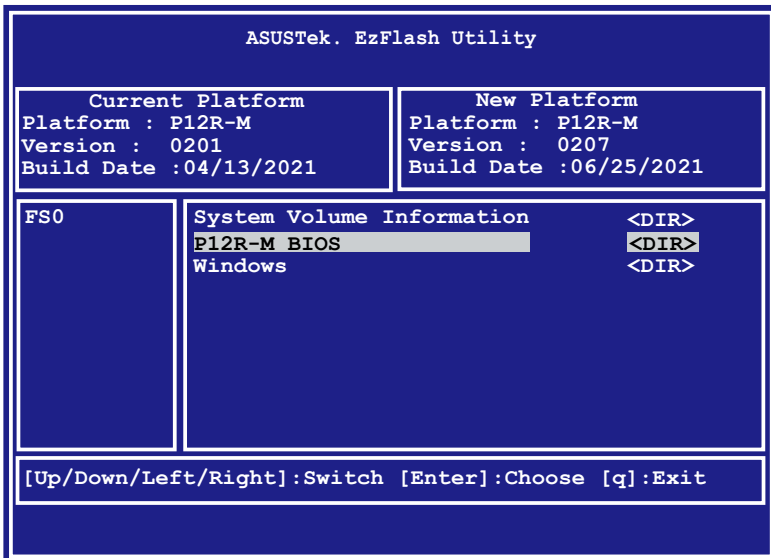

3. Press the Left arrow key to switch to the **Drive** field.
4. Press the Up/Down arrow keys to find the USB flash disk that contains the latest BIOS then press <Enter>.
5. Press the Right arrow key to switch to the **Folder Info** field.
6. Press the Up/Down arrow keys to find the BIOS file then press <Enter>.
7. Reboot the system when the update process is done.



-
- This function can support devices such as a USB flash disk with FAT 32/16 format and single partition only.
 - DO NOT shut down or reset the system while updating the BIOS to prevent system boot failure!
-



Ensure to load the BIOS default settings to ensure system compatibility and stability. Press <F5> and select **Yes** to load the BIOS default settings.

4.1.3 BUPDATER utility



The succeeding BIOS screens are for reference only. The actual BIOS screen displays may not be the same as shown.

The BUPDATER utility allows you to update the BIOS file in DOS environment using a bootable USB flash disk drive with the updated BIOS file.

Updating the BIOS file

To update the BIOS file using the BUPDATER utility:

1. Visit the ASUS website at www.asus.com and download the latest BIOS file for the motherboard. Save the BIOS file to a bootable USB flash disk drive.
2. Download the BUPDATER utility (BUPDATER.exe) from the ASUS support website at www.asus.com/support to the bootable USB flash disk drive you created earlier.
3. Boot the system in DOS mode, then at the prompt, type:

```
BUPDATER /i[filename].CAP
```

where [filename] is the latest or the original BIOS file on the bootable USB flash disk drive, then press <Enter>.

```
A:\>BUPDATER /i[file name]CAP
```

The utility verifies the file, then starts updating the BIOS file.

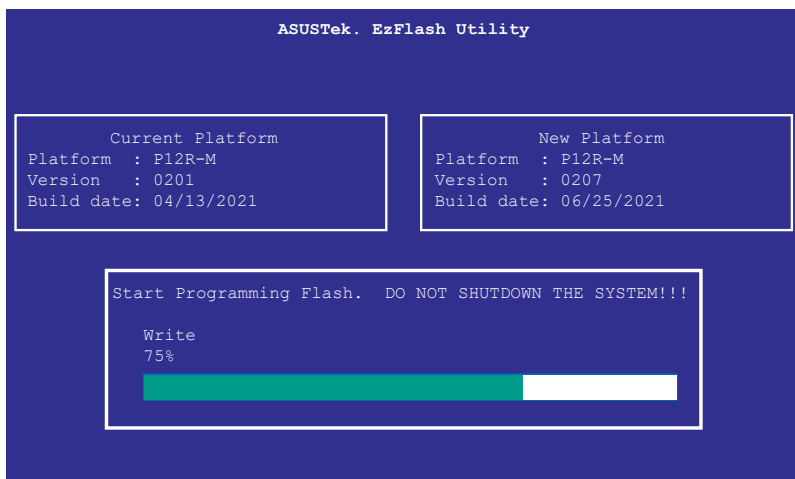

DO NOT shut down or reset the system while updating the BIOS to prevent system boot failure!

The utility returns to the DOS prompt after the BIOS update process is completed.

4. Reboot the system from the hard disk drive.

```
The BIOS update is finished! Please restart your system.  
C:\>
```

4.2 BIOS setup program

This motherboard supports a programmable firmware chip that you can update using the provided utility described in section **4.1 Managing and updating your BIOS**.

Use the BIOS Setup program when you are installing a motherboard, reconfiguring your system, or prompted to “Run Setup.” This section explains how to configure your system using this utility.

Even if you are not prompted to use the Setup program, you can change the configuration of your computer in the future. For example, you can enable the security password feature or change the power management settings. This requires you to reconfigure your system using the BIOS Setup program so that the computer can recognize these changes and record them in the NVRAM of the firmware chip.

The firmware chip on the motherboard stores the Setup utility. When you start up the computer, the system provides you with the opportunity to run this program. Press during the Power-On Self-Test (POST) to enter the Setup utility; otherwise, POST continues with its test routines.

If you wish to enter Setup after POST, restart the system by pressing <Ctrl+Alt+Delete>, or by pressing the reset button on the system chassis. You can also restart by turning the system off and then back on. Do this last option only if the first two failed.

The Setup program is designed to make it as easy to use as possible. Being a menu-driven program, it lets you scroll through the various sub-menus and make your selections from the available options using the navigation keys.



-
- The default BIOS settings for this motherboard apply for most conditions to ensure optimum performance. If the system becomes unstable after changing any BIOS settings, load the default settings to ensure system compatibility and stability. Press <F5> and select Yes to load the BIOS default settings.
 - The BIOS setup screens shown in this section are for reference purposes only, and may not exactly match what you see on your screen.
 - Visit the ASUS website (www.asus.com) to download the latest BIOS file for this motherboard.
-

4.2.1 BIOS menu screen

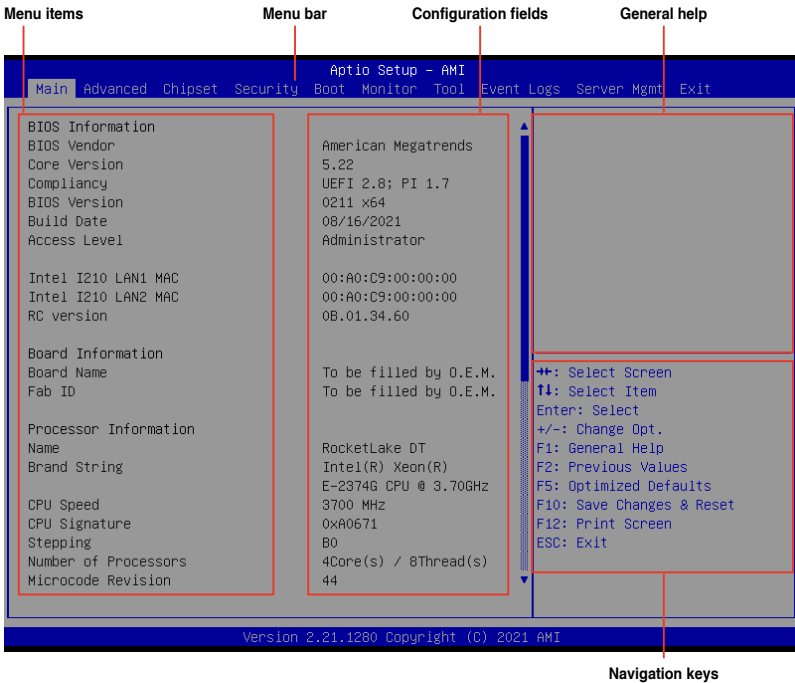

4.2.2 Menu bar

The menu bar on top of the screen has the following main items:

- Main** For changing the basic system configuration
- Advanced** For changing the advanced system settings
- Chipset** For changing the chipset settings
- Security** For changing the security settings
- Boot** For changing the system boot configuration
- Monitor** For displaying the system temperature, power status, and changing the fan settings
- Tool** For configuring options for special functions
- Event Logs** For changing the event log settings
- Server Mgmt** For changing the server mgmt settings
- Exit** For selecting the save & exit options

To select an item on the menu bar, press the right or left arrow key on the keyboard until the desired item is highlighted.

4.2.3 Menu items

The highlighted item on the menu bar displays the specific items for that menu. For example, selecting Main shows the Main menu items.

The other items (Advanced, Chipset, Security, Boot, Monitor, Tool, Event Logs, Server Mgmt, and Exit) on the menu bar have their respective menu items.

4.2.4 Submenu items

A solid triangle before each item on any menu screen means that the item has a submenu. To display the submenu, select the item then press <Enter>.

4.2.5 Navigation keys

At the bottom right corner of a menu screen are the navigation keys for the BIOS setup program. Use the navigation keys to select items in the menu and change the settings.

4.2.6 General help

At the top right corner of the menu screen is a brief description of the selected item.

4.2.7 Configuration fields

These fields show the values for the menu items. If an item is user-configurable, you can change the value of the field opposite the item. You cannot select an item that is not user-configurable.

A configurable field is enclosed in brackets, and is highlighted when selected. To change the value of a field, select it and press <Enter> to display a list of options.

4.2.8 Pop-up window

Select a menu item and press <Enter> to display a pop-up window with the configuration options for that item.

4.2.9 Scroll bar

A scroll bar appears on the right side of a menu screen when there are items that do not fit on the screen. Press the Up/Down arrow keys or <Page Up> / <Page Down> keys to display the other items on the screen.

4.3 Main menu

When you enter the BIOS Setup program, the Main menu screen appears. The Main menu provides you an overview of the basic system information, and allows you to set the system date, time, and language.

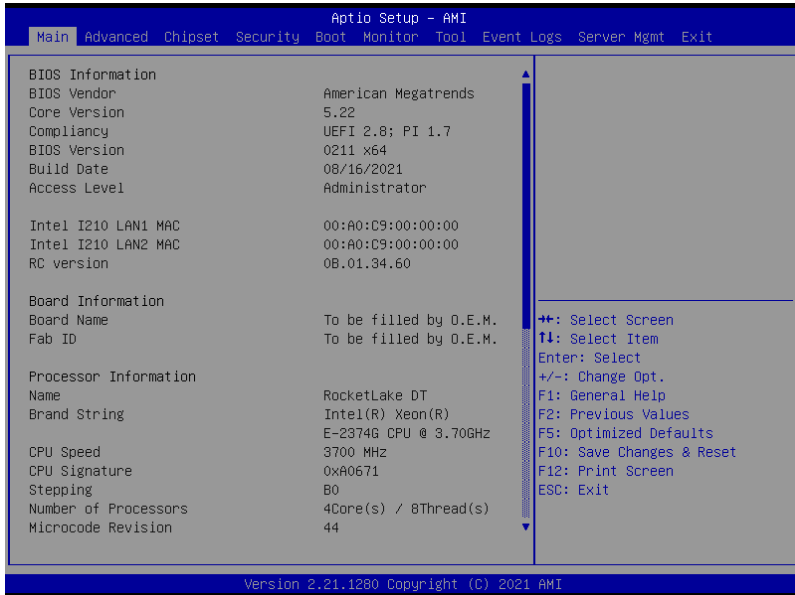

Navigate to the second page of the screen to see the rest of items in this menu by pressing the Up or Down arrow keys.



To quickly go to the last item of the second page, press the **Page Down** button. Press the **Page Up** button to go back to the first item in the first page.

4.3.1 System Language [English]

Allows you to select the system default language.

4.3.2 System Date [Day xx/xx/xxxx]

Allows you to set the system date.

4.3.3 System Time [xx:xx:xx]

Allows you to set the system time.

4.4 Advanced menu

The Advanced menu items allow you to change the settings for the CPU and other system devices.



Take caution when changing the settings of the Advanced menu items. Incorrect field values can cause the system to malfunction.

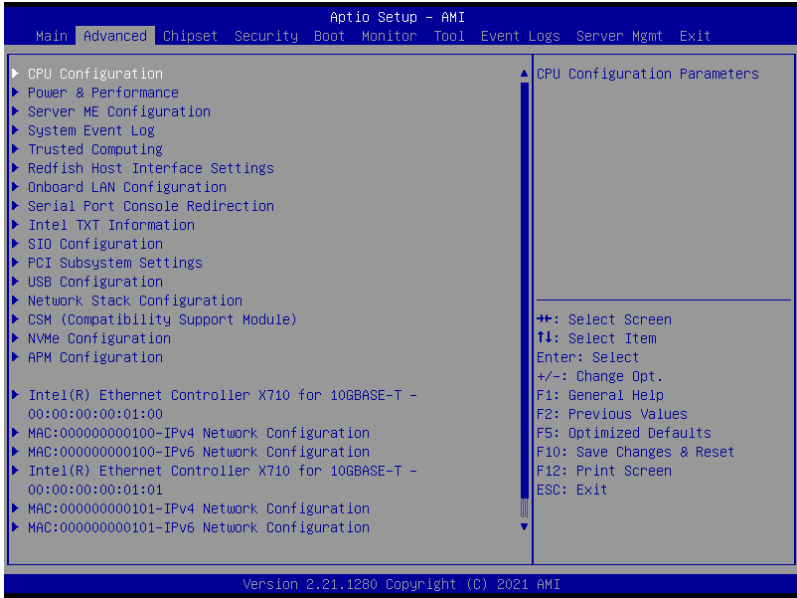

4.4.1 CPU Configuration

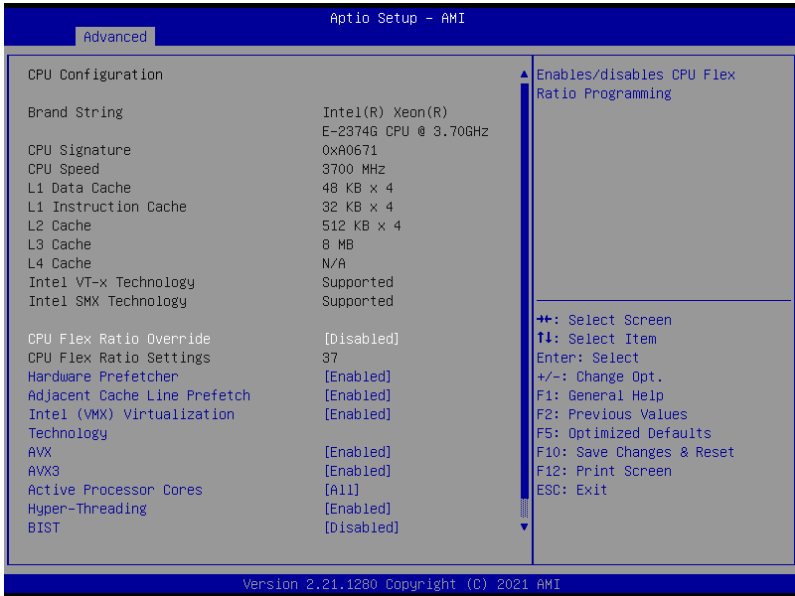

CPU Flex Ratio Override [Disabled]

Allows you to enable or disable CPU Flex Ratio Override.

Configuration options: [Disabled] [Enabled]



The following item appears only when **CPU Flex Ratio Override** is set to **[Enabled]**.

CPU Flex Ratio Settings [37]

Allows you to set the CPU Flex Ratio. This value must be between the Max Efficiency Ratio (LFM) and the Maximum non-turbo ratio set by the Hardware (HFW).

Hardware Prefetcher [Enabled]

Allows you to turn on/off the MLC streamer prefetcher.

Configuration options: [Disabled] [Enabled]

Adjacent Cache Prefetch [Enabled]

Allows you to turn on/off prefetching of adjacent cache lines.

Configuration options: [Disabled] [Enabled]

Intel (VMX) Virtualization Technology [Enabled]

Enable this item to allow a VMM to utilize the additional hardware capabilities provided by Vanderpool Technology.

Configuration options: [Disabled] [Enabled]

AVX [Enabled]

Allows you to enable or disable the AVX 2/3 Instructions. This is applicable for Big Core only.
Configuration options: [Disabled] [Enabled]

AVX3 [Enabled]

Allows you to enable or disable the AVX 3 Instructions. This is applicable for Big Core only.
Configuration options: [Disabled] [Enabled]

Active Processor Cores [All]

Allows you to set the number of cores to enable in each processor package.
Configuration options: [All] [1] [2] [3]

Hyper-Threading [Enabled]

Allows a hyper-threading processor to appear as two logical processors, allowing the operating system to schedule two threads or processes simultaneously.

[Enabled] For two threads per activated core.

[Disabled] For only one thread per activated core.

BIST [Disabled]

Allows you to enable or disable BIST (Built-In Self Test) on reset.
Configuration options: [Disabled] [Enabled]

AES [Enabled]

Allows you to enable or disable AES (Advanced Encryption Standard).
Configuration options: [Disabled] [Enabled]

Intel Trusted Execution Technology [Disabled]

Allows you to enable or disable utilization of additional hardware capabilities provided by Intel(R) Trusted Execution Technology. Changes require a full power cycle to take effect.
Configuration options: [Disabled] [Enabled]

4.4.2 Power & Performance

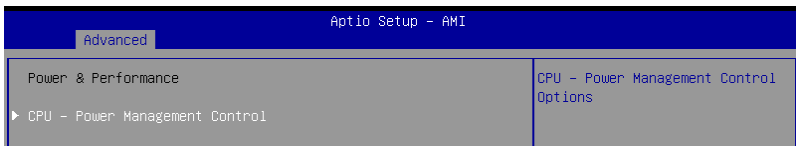

CPU - Power Management Control

Boot performance mode [Turbo Performance]

This item allows you to select the performance state that the BIOS will set starting from reset vector.

Configuration options: [Max Battery] [Max Non-Turbo Performance] [Turbo Performance]

Intel(R) SpeedStep(tm) [Enabled]

Allows more than two frequency ranges to be supported.
Configuration options: [Disabled] [Enabled]

Race To Halt (RTH) [Enabled]

Allows you to enable or disable Race To Halt feature. RTH dynamically increases the CPU frequency to quickly enter the package C-State and reduce the overall power. RTH is controlled through MSR 1FC bit 20.

Configuration options: [Disabled] [Enabled]

Intel(R) Speed Shift Technology [Native Mode]

Allows you to enable or disable Intel(R) Speed Shift Technology support. Enabling will expose the CPPC v2 interface to allow for hardware controlled P-states.

Configuration options: [Disabled] [Native Mode] [Out of Band Mode]

Per Core P State OS control mode [Enabled]

Allows you to enable or disable Per Core P state OS control mode. Disabling will set Bit 31 = 1 command 0x06. When set the highest core request is used for all other core requests.

Configuration options: [Disabled] [Enabled]

HwP Autonomous Per Core P State [Enabled]

[Disabled] Disable Autonomous PCPS (Bit 30 = 1, command 0x11). Autonomous will request the same value for all cores all the time.

[Enabled] Enable PCPS (default Bit 30 = 0, command 0x11).

HwP Autonomous EPP Grouping [Enabled]

[Disabled] Disable EPP grouping (default Bit 29 = 1, command 0x11). Autonomous will not necessarily request same values for all cores with same EPP.

[Enabled] Enable EPP grouping (default Bit 29 = 1, command 0x11). Autonomous will request the same value for all cores with same EPP.

HwP Fast MSR Support [Enabled]

Allows you to enable or disable HwP Fast MSR Support for IA32_HWP_REQUEST MSR.

Configuration options: [Disabled] [Enabled]

HDC Control [Enabled]

[Disabled] Disable HDC.

[Enabled] Can be enable by OS if OS native support available.

Turbo Mode [Enabled]

Allows you to enable or disable processor turbo mode if EMTTM is also enabled.

Configuration options: [Disabled] [Enabled]

C-States [Enabled]

Allows you to enable or disable CPU power management, this allows the CPU to enter C-state when not it is not 100 % utilized.

Configuration options: [Disabled] [Enabled]



The following items appears only when **C-States** is set to **[Enabled]**.

Enhanced C-States [Enabled]

Allows you to enable or disable C11E. Enable this item to allow the CPU to switch to minimum speed when all cores enter C-State.

Configuration options: [Disabled] [Enabled]

C-State Auto Demotion [C1]

This item allows you to configure the C-state auto demotion.

Configuration options: [Disabled] [C1]

C-State Un-demotion [C1]

This item allows you to configure the C-state Un-demotion.

Configuration options: [Disabled] [C1]

Package C-State Demotion [Enabled]

This item allows you to configure the Package C-State Demotion.

Configuration options: [Disabled] [Enabled]

Package C-State Un-demotion [Enabled]

This item allows you to configure the Package C-state Un-demotion.

Configuration options: [Disabled] [Enabled]

Package C-state Limit [Auto]

This item allows you to select the maximum package C-state limit setting. Setting this item to CPU Default will leave it to Factory default value. Setting this item to Auto will initialize to deepest available Package C State Limit.

Configuration options: [C0/C1] [C2] [C3] [C6] [C7] [C7S] [C8] [C9] [C10] [CPU Default] [Auto]

Thermal Monitor [Enabled]

Allows you to enable or disable Thermal Monitoring.

Configuration options: [Disabled] [Enabled]

4.4.3 Server ME Configuration

Displays the Server ME Technology parameters on your system. Scroll using <Page Up> / <Page Down> keys to see more items.

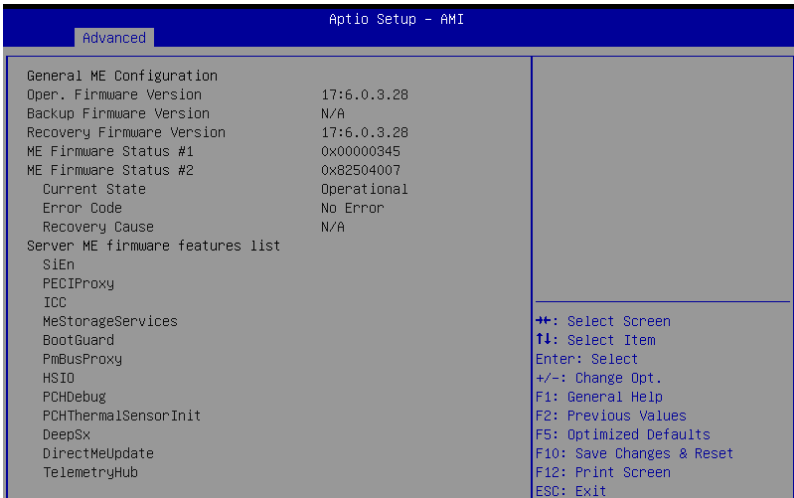

4.4.4 System Event Log

Allows you to view the System Event Main Screen and RAS features enabling.

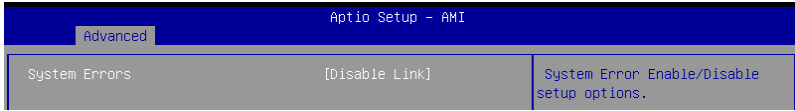

System Errors [Disabled]

Allows you to enable or disable system error setup options.

Configuration options: [Disabled] [Enabled]



The following items appear only when **System Errors** is set to **[Enabled]**.

Whea Driver Support [Disabled]

Allows you to enable or disable Whea Driver Support. This option may not be effective with some OS.

Configuration options: [Disabled] [Enabled]



The following items appear only when **Whea Driver Support** is set to **[Enabled]**.

Whea FFM Logging [Disable Link]

Allows you to enable or disable Whea FFM logging of errors.

Configuration options: [Disable Link] [Enabled]

WHEA/UEFI Record Format [UEFI 2.2]

Allows you to set WHEA/UEFI FFM Error record format.

Configuration options: [UEFI 2.2] [UEFI 2.3.1]

Memory Error Enabling:

Press <Enter> to view or change Memory errors enabling options.

Memory corrected Error enabling [Disable Link]

Allows you to enable or disable Memory corrected Errors.

Configuration options: [Disable Link] [Enabled]

Memory uncorrected Error enabling [Disable Link]

Allows you to enable or disable Memory uncorrected Errors.

Configuration options: [Disable Link] [Enabled]

PCH Error Enable [No]

Allows you to enable or disable Whea Driver Support. This option may not be effective with some OS.

Configuration options: [No] [Yes]



The following item appears only when **PCH Error Enable** is set to **[Yes]**.

PCI/PCI Error Enabling:

Press <Enter> to view or change PCH errors enabling options.

PCI-Ex Error Enable [No]

Configuration options: [No] [Yes]

Fatal Error Enable [Enabled]

Allows you to enable and escalate fatal errors to error pins.

Configuration options: [Disable Link] [Enabled]

Uncorrected Error Enable [Enabled]

Allows you to enable and escalate Uncorrectable/Recoverable errors to error pins.

Configuration options: [Disable Link] [Enabled]

Corrected Error Enable [Enabled]

Allows you to enable and escalate Correctable Errors to error pins.

Configuration options: [Disable Link] [Enabled]

Enable SERR propagation [No]

Configuration options: [No] [Yes]

Enable PERR propagation [No]

Configuration options: [No] [Yes]

4.4.5 Trusted Computing

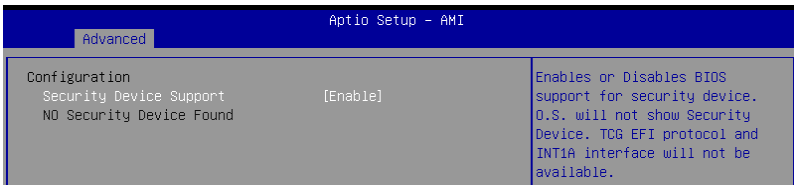

Security Device Support [Enabled]

This item allows you to enable or disable BIOS support for security device. O.S. will not show Security Device. TCG EFI protocol and INT1A interface will not be available.

Configuration options: [Disabled] [Enabled]

4.4.6 Redfish Host Interface Settings

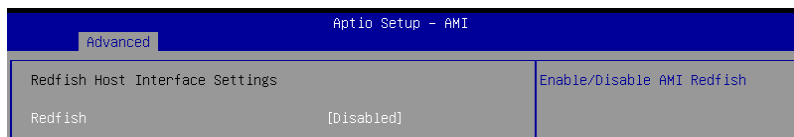

Redfish [Disabled]

Allows you to enable or disable Redfish.
Configuration options: [Disabled] [Enabled]



The following items appear only when **Redfish** is set to **[Enabled]**.

Authentication mode [Basic Authentication]

Allows you to select the authentication mode.
Configuration options: [Basic Authentication] [Session Authentication]

Redfish BMC Settings

IP address

Enter the IP address.

IP Mask address

Enter the IP Mask address.

IP Port

Enter the IP Port.

4.4.7 Onboard LAN Configuration



The Onboard LAN configuration may differ between models.

P12R-M

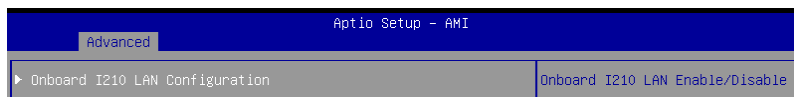

Onboard I210 LAN Configuration

Intel I210 LAN1-2

LAN Enable [Enabled]

Allows you to enable or disable the Intel LAN.
Configuration options: [Disabled] [Enabled]

P12R-M/10G-2T

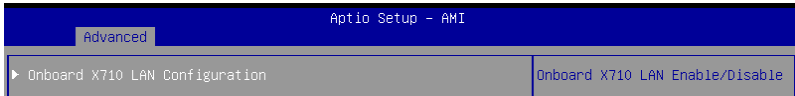

Onboard X710 LAN Configuration

Intel X710 LAN1-2

LAN Enable [Enabled]

Allows you to enable or disable the Intel LAN.
Configuration options: [Disabled] [Enabled]

4.4.8 Serial Port Console Redirection

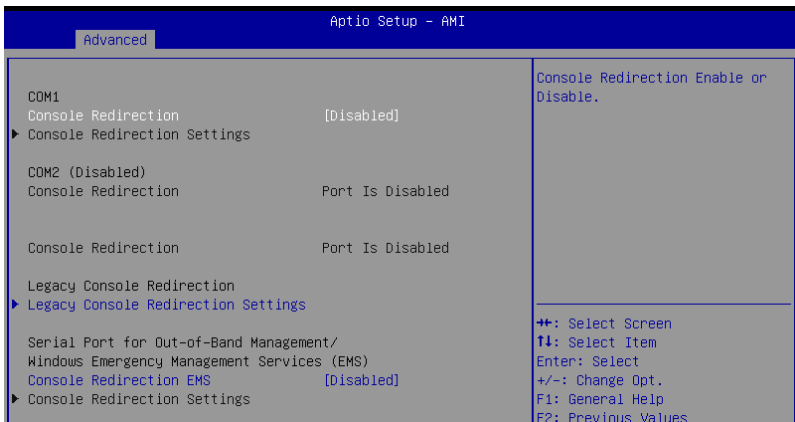

COM1

Console Redirection [Disabled]

Allows you to enable or disable the console redirection feature.
Configuration options: [Disabled] [Enabled]



The following item appears only when **Console Redirection** is set to **[Enabled]**.

Console Redirection Settings

These items become configurable only when you enable the **Console Redirection** item. The settings specify how the host computer and the remote computer (which the user is using) will exchange data. Both computers should have the same or compatible settings.

Terminal Type [ANSI]

Allows you to set the terminal type.

- [VT100] ASCII char set.
- [VT100+] Extends VT100 to support color, function keys, etc.
- [VT-UTF8] Uses UTF8 encoding to map Unicode chars onto 1 or more bytes.
- [ANSI] Extended ASCII char set.

Bits per second [115200]

Selects serial port transmission speed. The speed must be matched on the other side. Long or noisy lines may require lower speeds.

Configuration options: [9600] [19200] [38400] [57600] [115200]

Data Bits [8]

Configuration options: [7] [8]

Parity [None]

A parity bit can be sent with the data bits to detect some transmission errors. [Mark] and [Space] parity do not allow for error detection.

- [None] None
- [Even] parity bit is 0 if the num of 1's in the data bits is even
- [Odd] parity bit is 0 if num of 1's in the data bits is odd
- [Mark] parity bit is always 1
- [Space] parity bit is always 0

Stop Bits [1]

Stop bits indicate the end of a serial data packet. (A start bit indicates the beginning.) The standard setting is 1 stop bit. Communication with slow devices may require more than 1 stop bit.

Configuration options: [1] [2]

Flow Control [None]

Flow control can prevent data loss from buffer overflow. When sending data, if the receiving buffers are full, a "stop" signal can be sent to stop the data flow. Once the buffers are empty, a "start" signal can be sent to re-start the flow. Hardware flow control uses two wires to send start/stop signals.

Configuration options: [None] [Hardware RTS/CTS]

VT -UTF8 Combo Key Support [Enabled]

This allows you to enable the VT -UTF8 Combination Key Support for ANSI/VT100 terminals.

Configuration options: [Disabled] [Enabled]

Recorder Mode [Disabled]

With this mode enabled only text will be sent. This is to capture Terminal data.

Configuration options: [Disabled] [Enabled]

Resolution 100x31 [Enabled]

This allows you to enable or disable extended terminal resolution.

Configuration options: [Disabled] [Enabled]

Putty Keypad [VT100]

This allows you to select the FunctionKey and Keypad on Putty.

Configuration options: [VT100] [LINUX] [XTERMR6] [SCO] [ESCN] [VT400]

Legacy Console Redirection Settings

Legacy Console Redirection Port [COM1]

Allows you to select a COM port to display redirection of Legacy OS and Legacy OPROM Messages.

Configuration options: [COM1] [COM2 (Disabled)]

Resolution [80x24]

Allows you to select a the number of rows and columns in supported redirection.

Configuration options: [80x24] [80x25]

Redirect After POST [Always Enable]

Allows you to select the redirection after POST.

Configuration options: [Always Enable] [BootLoader]

Serial Port for Out-of-Band Management/Windows Emergency Management Services (EMS)

Console Redirection [Disabled]

Allows you to enable or disable the console redirection feature.

Configuration options: [Disabled] [Enabled]



The following item appears only when **Console Redirection** is set to **[Enabled]**.

Console Redirection Settings

Out-of-Band Mgmt Port [COM1]

Microsoft Windows Emergency Management Services (EMS) allow for remote management of a Windows Server OS through a serial port.

Configuration options: [COM1] [COM2 (Disabled)]

Terminal Type [VT-UTF8]

Microsoft Windows Emergency Management Services (EMS) allow for remote management of a Windows Server OS through a serial port.

Configuration options: [VT100] [VT100+] [VT-UTF8] [ANSI]

Bits per second [115200]

Microsoft Windows Emergency Management Services (EMS) allow for remote management of a Windows Server OS through a serial port.

Configuration options: [9600] [19200] [57600] [115200]

Flow Control [None]

Microsoft Windows Emergency Management Services (EMS) allow for remote management of a Windows Server OS through a serial port.

Configuration options: [None] [Hardware RTS/CTS] [Software Xon/Xoff]

4.4.9 Intel TXT Information

You may view the Intel TXT information in this menu.

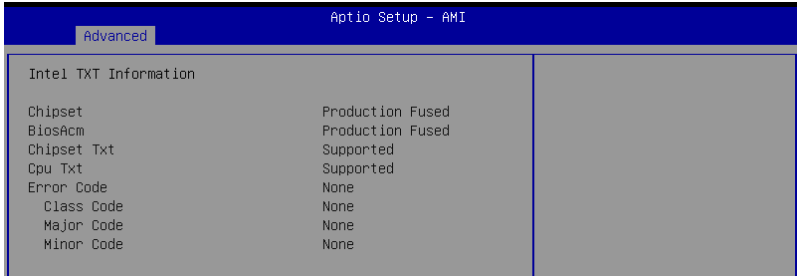

4.4.10 SIO Configuration

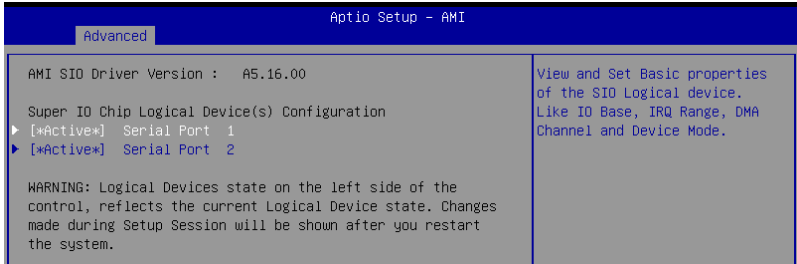

Logical Devices state on the left side of the control, reflects the current Logical Device state. Changes made during Setup Session will be shown after you restart the system.

[*Active*] Serial Port 1 / [*Active*] Serial Port 2

Allows you to view and set basic properties of the SIO Logical device. Like IO Base, IRQ Range, DMA Channel, and Device Mode.

Use This Device [Enabled]

Allows you to enable or disable this Logical Device.

Configuration options: [Disabled] [Enabled]



The following item appears only when **Use This Device** is set to **[Enabled]**.



Disabling SIO Logical Devices may have unwanted side effects. **PROCEED WITH CAUTION.**

Possible: [Use Automatic Settings]

Allows the user to change the device resource settings. New settings will be reflected no this setup page after system restarts.

Configuration options: [Use Automatic Settings] [IO=3F8h; IRQ=4; DMA;] [IO=3F8h; IRQ=3, 4, 5, 7, 9, 10, 11, 12; DMA;] [IO=2F8h; IRQ=3, 4, 5, 7, 9, 10, 11, 12; DMA;] [IO=3E8h; IRQ=3, 4, 5, 7, 9, 10, 11, 12; DMA;] [IO=2E8h; IRQ=3, 4, 5, 7, 9, 10, 11, 12; DMA;]

4.4.11 PCI Subsystem Settings

Allows you to configure PCI, PCI-X, and PCI Express Settings.

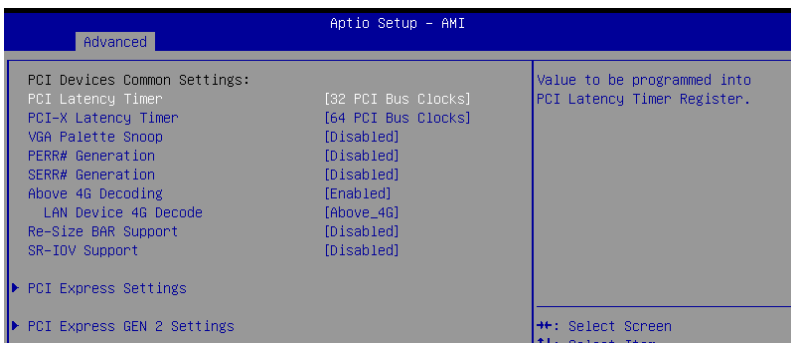

PCI Latency Timer [32 PCI Bus Clocks]

Allows you to set the value to be programmed into PCI Latency Timer Register.

Configuration options: [32 PCI Bus Clocks] [64 PCI Bus Clocks] [96 PCI Bus Clocks] [128 PCI Bus Clocks] [160 PCI Bus Clocks] [192 PCI Bus Clocks] [224 PCI Bus Clocks] [248 PCI Bus Clocks]

PCI-X Latency Timer [64 PCI Bus Clocks]

Allows you to set the value to be programmed into PCI Latency Timer Register.

Configuration options: [32 PCI Bus Clocks] [64 PCI Bus Clocks] [96 PCI Bus Clocks] [128 PCI Bus Clocks] [160 PCI Bus Clocks] [192 PCI Bus Clocks] [224 PCI Bus Clocks] [248 PCI Bus Clocks]

VGA Palette Snoop [Disabled]

Allows you to enable or disable VGA Palette Registers Snooping.

Configuration options: [Disabled] [Enabled]

PERR# Generation [Disabled]

Allows you to enable or disable PCI Device to Generate PERR#.
Configuration options: [Disabled] [Enabled]

SERR# Generation [Disabled]

Allows you to enable or disable PCI Device to Generate SERR#.
Configuration options: [Disabled] [Enabled]

Above 4G Decoding [Enabled]

Allows you to enable or disable 64-bit capable devices to be decoded in above 4G address space. It only works if the system supports 64-bit PCI decoding.
Configuration options: [Disabled] [Enabled]



The following items appear only when **Above 4G Decoding** is set to **[Enabled]**.

LAN Device 4G Decode [Above_4G]

Configuration options: [Auto] [Above_4G]

Re-Size BAR Support [Disabled]

If system has Resizable BAR capable PCIe Devices, this option enables or disables Resizable BAR Support. (Only if system supports 64-bit PCI Decoding).
Configuration options: [Disabled] [Auto]



To enable Re-Size BAR Support for harnessing full GPU memory, please set **CSM (Compatibility Support Module)** to **[Disabled]**.

SR-IOV Support [Disabled]

Allows you to enable or disable Single Root IO Virtualization Support, if your system has SR-IOV capable PCIe Devices.
Configuration options: [Disabled] [Enabled]

PCI Express Settings

The items in this submenu allow you change PCI Express Devices Settings.

PCI Express Device Register Settings

Relaxed Ordering [Enabled]

Allows you to enable or disable PCI Express Device Relaxed Ordering.
Configuration options: [Disabled] [Enabled]

Extended Tag [Disabled]

If this item is set to Enabled, it will allow Device to use 8-bit Tag field as a requester.
Configuration options: [Disabled] [Enabled]

No Snoop [Enabled]

Allows you to enable or disable PCI Express Device No Snoop option.
Configuration options: [Disabled] [Enabled]

Maximum Payload [Auto]

Allows you to set Maximum Payload of PCI Express Device or allow System BIOS to select the value.

Configuration options: [Auto] [128 Bytes] [256 Bytes] [512 Bytes] [1024 Bytes] [2048 Bytes] [4096 Bytes]

Maximum Read Request [Auto]

Allows you to set Maximum Read Request Size of PCI Express Device or allow System BIOS to select the value.

Configuration options: [Auto] [128 Bytes] [256 Bytes] [512 Bytes] [1024 Bytes] [2048 Bytes] [4096 Bytes]

PCI Express Link Register Settings

ASPM Support [Disabled]

Allows you to set the ASPM level.

[Disabled]	Disables ASPM.
[Auto]	BIOS auto configure.
[Force L0s]	Force all links to L0 State.



Enabling ASPM may cause some PCI-E devices to fail.

Extended Synch [Disabled]

If this item is enabled, it will allow generation of Extended Synchronization patterns.

Configuration options: [Disabled] [Enabled]

Link Training Retry [5]

Allows you to define the number of Retry Attempts software will take to retrain the link if previous training attempt was unsuccessful.

Configuration options: [Disabled] [2] [3] [5]

Link Training Timeout (uS) [1000]

Allows you to define the number of Microseconds software will wait before polling 'link Training' bit in Link Status register.

Configuration options: [10] - [10000]

Unpopulated Links [Keep Link ON]

If this option is set to **[Disable Link]**, in order to save power, software will disable unpopulated PCI Express Links.

Configuration options: [Keep Link ON] [Disabled Link]

PCI Express GEN 2 Settings

The items in this submenu allow you change PCI Express GEN Devices Settings.

PCI Express GEN2 Device Register Settings

Completion Timeout [Default]

In device Functions that support Completion Timeout programmability, allows system software to modify the Completion Timeout value.

[Default]	50us to 50ms.
[Shorter]	Software will use shorter timeout ranges supported by hardware.
[Longer]	Software will use longer timeout ranges.
[Disabled]	Disable completion timeout.

ARI Forwarding [Disabled]

If supported by hardware and set to **[Enabled]**, the Downstream Port disables its traditional Device Number field being 0 enforcement when turning a Type1 Configuration Request into a Type0 Configuration Request, permitting access to Extended Functions in an ARI Device immediately below the Port.

Configuration options: [Disabled] [Enabled]

AtomicOp Requester Enable [Disabled]

If supported by hardware and set to **[Enabled]**, this function initiates AtomicOp Requests only if Bus Master Enable bit is in the Command Register Set.

Configuration options: [Disabled] [Enabled]

AtomicOp Egress Blocking [Disabled]

If supported by hardware and set to **[Enabled]**, outbound AtomicOp Requests via Egress Ports will be blocked.

Configuration options: [Disabled] [Enabled]

IDO Request Enable [Disabled]

If supported by hardware and set to **[Enabled]**, this permits setting the number of ID-Based Ordering (IDO) bit (Attribute[2]) requests to be initiated.

Configuration options: [Disabled] [Enabled]

IDO Completion Enable [Disabled]

If supported by hardware and set to **[Enabled]**, this permits setting the number of ID-Based Ordering (IDO) bit (Attribute[2]) requests to be initiated.

Configuration options: [Disabled] [Enabled]

LTR Mechanism Enable [Disabled]

If supported by hardware and set to **[Enabled]**, this enables the Latency Tolerance Reporting (LTR) Mechanism.

Configuration options: [Disabled] [Enabled]

End-End TLP Prefix Blocking [Disabled]

If supported by hardware and set to **[Enabled]**, this function will block forwarding of TLPs containing End-End TLP Prefixes.

Configuration options: [Disabled] [Enabled]

PCI Express GEN2 Link Register Settings

Target Link Speed [Auto]

If supported by hardware and set to **[Force to X.X GT/s]**, for Downstream Ports, this sets an upper limit on Link operational speed by restricting the values advertised by the Upstream component in its training sequences. When **[Auto]** is selected HW initialized data will be used.

Configuration options: [Disabled] [Force to 2.5 GT/s] [Force to 5.0 GT/s] [Force to 8.0 GT/s] [Force to 16.0 GT/s] [Force to 32.0 GT/s]

Clock Power Management [Disabled]

If supported by hardware and set to **[Enabled]**, the device is permitted to use CLKREQ# signal for power management of Link clock in accordance to protocol defined in appropriate form factor specification.

Configuration options: [Disabled] [Enabled]

Compliance SOS [Disabled]

If supported by hardware and set to **[Enabled]**, this will force LTSSM to send SKP Ordered Sets between sequences when sending Compliance Pattern or Modified Compliance Pattern.

Configuration options: [Disabled] [Enabled]

Hardware Autonomous Width [Enabled]

If supported by hardware and set to **[Disabled]**, this will disable the hardware's ability to change link width except width size reduction for the purpose of correcting unstable link operation.

Configuration options: [Disabled] [Enabled]

Hardware Autonomous Speed [Enabled]

If supported by hardware and set to **[Disabled]**, this will disable the hardware's ability to change link speed except speed rate reduction for the purpose of correcting unstable link operation.

Configuration options: [Disabled] [Enabled]

4.4.12 USB Configuration

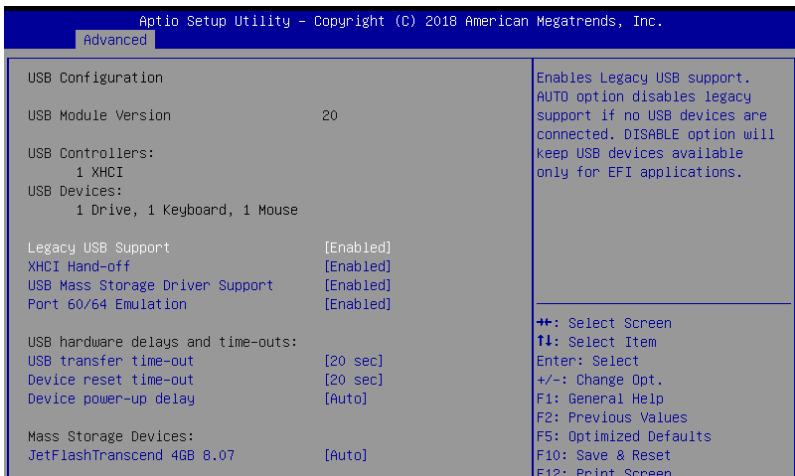

Legacy USB Support [Enabled]

[Disabled] USB devices are available only for EFI applications.

[Enabled] Enables the support for USB devices on legacy operating systems (OS).

[Auto] Automatically disables the Legacy USB support if USB devices are not connected.

XHCI Hand-off [Enabled]

Allows you to enable or disable workaround for OSEs without XHCI hand-off support. The XHCI ownership change should be claimed by XHCI driver.

Configuration options: [Disabled] [Enabled]

USB Mass Storage Driver Support [Enabled]

Allows you to enable or disable USB Mass Storage driver support.
Configuration options: [Disabled] [Enabled]

Port 60/64 Emulation [Enabled]

Allows you to enable or disable Port 60/64 Emulation.
Configuration options: [Disabled] [Enabled]

USB hardware delays and time-outs

USB transfer time-out [20 sec]

Allows you to set the time-out value for Control, Bulk, and Interrupt transfers.
Configuration options: [1 sec] [5 sec] [10 sec] [20 sec]

Device reset time-out [20 sec]

Allows you to set the device reset time-out value.
Configuration options: [10 sec] [20 sec] [30 sec] [40 sec]

Device power-up delay [Auto]

Allows you to set the maximum time the device takes before the device reports itself to the host controller properly. **[Auto]** uses default value; for a Root port it is 100 ms, for a Hub port the delay is taken from Hub descriptor.
Configuration options: [Auto] [Manual]



The following item appears only when **Device power-up delay** is set to **[Manual]**.

Device power-up delay in seconds [5]

Allows you to set the device power-up delay in seconds. Use the <+> or <-> to adjust the value. The values range from 1 to 40.

Mass Storage Devices

Allows you to select the mass storage device emulation type for devices connected.
Configuration options: [Auto] [Floppy] [Forced FDD] [Hard Disk] [CD-ROM]

4.4.13 Network Stack Configuration

Allows you to configure the network stack configuration.

Advanced		
Aptio Setup - AMI		
Network Stack	[Enabled]	Enable/Disable UEFI Network Stack
IPv4 PXE Support	[Disabled]	
IPv4 HTTP Support	[Disabled]	
IPv6 PXE Support	[Disabled]	
IPv6 HTTP Support	[Disabled]	
PXE boot wait time	0	
Media detect count	1	

Network Stack [Enabled]

Allows you to enable or disable UEFI Network Stack.
Configuration options: [Disabled] [Enabled]



The following items appear only when **Network Stack** is set to **[Enabled]**.

Ipv4 PXE Support [Disabled]

Enables or disables the Ipv4 PXE Boot Support. If disabled, Ipv4 PXE boot option will not be created.

Configuration options: [Disabled] [Enabled]

Ipv4 HTTP Support [Disabled]

Enables or disables the Ipv4 HTTP Boot Support. If disabled, Ipv4 PXE boot option will not be created.

Configuration options: [Disabled] [Enabled]

Ipv6 PXE Support [Disabled]

Enables or disables the Ipv6 PXE Boot Support. If disabled, Ipv6 PXE boot option will not be created.

Configuration options: [Disabled] [Enabled]

Ipv6 HTTP Support [Disabled]

Enables or disables the Ipv6 HTTP Boot Support. If disabled, Ipv6 PXE boot option will not be created.

Configuration options: [Disabled] [Enabled]

PXE boot wait time [0]

Set the wait time to press ESC key to abort the PXE boot. Use the <+> or <-> to adjust the value. The values range from 0 to 5.

Media detect count [1]

Set the number of times presence of media will be checked. Use the <+> or <-> to adjust the value. The values range from 1 to 50.

4.4.14 CSM (Compatibility Support Module)

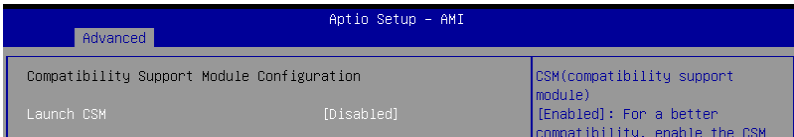

Launch CSM [Disabled]

This option allows you to enable or disable CSM Support.

[Disabled] Disable the CSM to fully support the Windows secure update and secure boot.

[Enabled] For a better compatibility, enable the CSM to fully support the non-UEFI driver add-on devices or the Windows UEFI mode.



The following items appear only when **Launch CSM** is set to **[Enabled]**.

GateA20 Active [Upon Request]

This allows you to set the GA20 option.

[Upon Request] GA20 can be disabled using BIOS services.

[Always] Do not allow disabling GA20; this option is useful when any RT code is executed above 1MB.

Interrupt 19 Capture [Immediate]

Allows you to select the BIOS reaction on INT19 trapping by Option ROM.

[Immediate] Execute the trap right away.

[Postponed] Execute the trap during legacy boot.

[Auto] Auto

Boot Device Control [UEFI only]

Allows you to select the devices boot-up mode according to the devices specification.

Devices with the selected mode will in the boot priority list.

Configuration options: [UEFI and Legacy OPROM] [Legacy OPROM only] [UEFI only]

Boot from Network Devices [Ignore]

Allows you to select the type of onboard LAN controller and installed LAN cards.

Network devices will run the selected type during the system boot. Selecting **[Ignore]** will accelerate the boot up time without running network devices during POST (Power-On Self-Test).

Configuration options: [Ignore] [UEFI only] [Legacy only]

Boot from Storage Devices [UEFI only]

Allows you to select the type of storage devices to run first during the system boot. It is recommended to select either **[Legacy only]** or **[UEFI only]** according to devices specification for better stability. Selecting **[Ignore]** will accelerate the boot up time without running network devices during POST (Power-On Self-Test).

Configuration options: [Ignore] [UEFI only] [Legacy only]

Launch Video OPROM policy [UEFI only]

This option controls the execution of UEFI and Legacy Video OPROM.

Configuration options: [Ignore] [UEFI only] [Legacy only]

Boot from PCI-E/PCI Expansion Devices [UEFI only]

Allows you to select the type of PCI-E/PCI Expansion devices to run first during the system boot.

Configuration options: [Ignore] [UEFI only] [Legacy only]

4.4.15 NVMe Configuration

You may view the NVMe controller and Drive information if an NVMe device is connected.



4.4.16 APM Configuration

This page will allow you to configure the Advance Power Management (APM) settings.

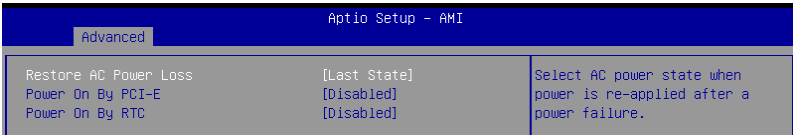

Restore AC Power Loss [Last State]

When set to **[Power Off]**, the system goes into off state after an AC power loss. When set to **[Power On]**, the system will reboot after an AC power loss. When set to **[Last State]**, the system goes into either off or on state, whatever the system state was before the AC power loss.

Configuration options: [Power Off] [Power On] [Last State]

Power On By PCI-E/PCI [Disabled]

[Disabled] Disables the PCI/PCIe devices to generate a wake event.

[Enabled] Enables the PCI/PCIe devices to generate a wake event.

Power On By RTC [Disabled]

[Disabled] Disables RTC to generate a wake event.

[Enabled] When set to [Enabled], the items **RTC Alarm Date (Days)** and **Hour/Minute/Second** will become user-configurable with set values.

4.4.17 Third-party UEFI driver configurations

Additional configuration options for third-party UEFI drivers installed to the system will appear in the section marked in red in the screenshot below.

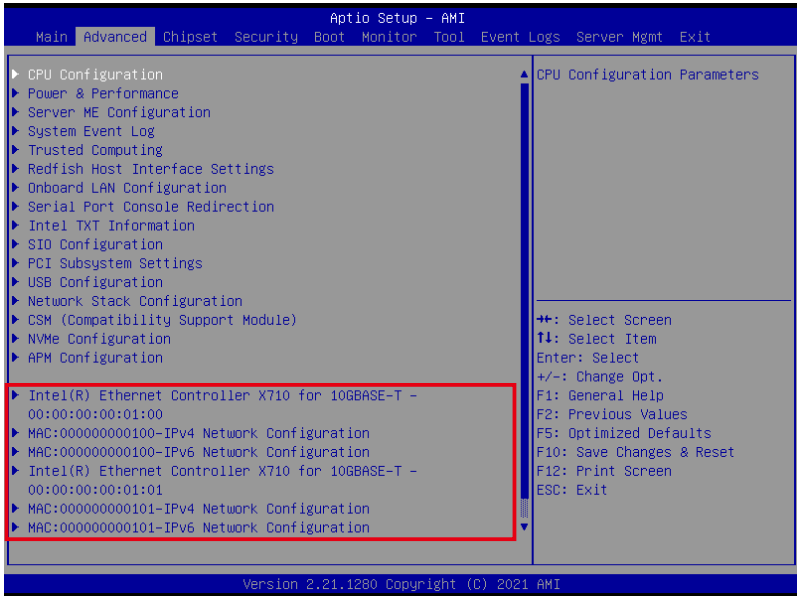

4.5 Chipset menu

The Chipset menu allows you to change the platform settings.



Take caution when changing the settings of the Chipset menu items. Incorrect field values can cause the system to malfunction.

4.5.1 System Agent (SA) Configuration

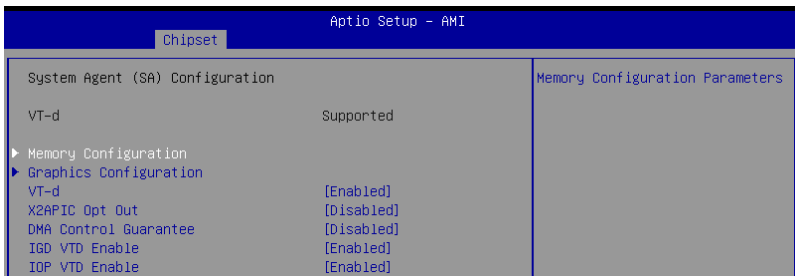

Memory Configuration

Maximum Memory Frequency [Auto]

Allows you to select the maximum memory frequency setting.

Configuration options: [Auto] [2133] [2400] [2666] [2933] [3200]

ECC Support [Enabled]

Allows you to enable or disable the DDR Ecc support.
Configuration options: [Disabled] [Enabled]

DDR Speed Control [Auto]

Allows you to set DDR Frequency and Gear1 / Gear2 control for all SAGV points.
Configuration options: [Auto] [Manual]

Memory Scrambler [Enabled]

Allows you to enable or disable Memory Scrambler support.
Configuration options: [Disabled] [Enabled]

Fast Boot [Disabled]

Allows you to enable or disable fast path thru the MRC.
Configuration options: [Disabled] [Enabled]

Graphics Configuration**Primary Display [Auto]**

Allows you to select which of CPU Graphics / PEG Graphics / PCIe Graphics device should be Primary Display.
Configuration options: [Auto] [CPU Graphics] [PCI] [HG]

Select PCIe Card [Auto]

Allows you to select the card used on the platform.
[Auto] Skip GPIO based Power Enable to dGPU.
[Elk Creek 4] DGPU Power Enable = ActiveLow.
[PEG Eval] DGPU Power Enable = ActiveHigh.

HG Delay After Power Enable [300]

The delay in milli-seconds after power enable.

HG Delay After Hold Reset [100]

The delay in milli-seconds after hold reset.

Internal Graphics [Auto]

Keep IGFX enabled based on the setup options.
Configuration options: [Auto] [Disabled] [Enabled]

VT-d [Enabled]

Allows you to enable or disable VT-d capability.
Configuration options: [Disabled] [Enabled]

X2APIC OPT Out [Disabled]

Allows you to enable or disable X2APIC_OPT_OUT bit.
Configuration options: [Disabled] [Enabled]

DMA Control Guarantee [Disabled]

Allows you to enable or disable DMA_CONTROL_GUARANTEE bit.
Configuration options: [Disabled] [Enabled]

IGD VTD Enable [Enabled]

Allows you to enable or disable IGD VTD.
Configuration options: [Disabled] [Enabled]

IOP VTD Enable [Enabled]

Allows you to enable or disable IOP VTD.
Configuration options: [Disabled] [Enabled]

CRID Support [Disabled]

Allows you to enable or disable SA CRID and TCSS CRID control for Intel SIPP.
Configuration options: [Disabled] [Enabled]

Above 4G Decoding [Enabled]

Allows you to enable or disable 64-bit capable devices to be decoded in above 4G address space. It only works if the system supports 64-bit PCI decoding.
Configuration options: [Disabled] [Enabled]

4.5.2 PCH Configuration



PCI Express Configuration

DMI Link ASPM Control [Disabled]

Allows you to enable or disable control of active state power management of DMI link.
Configuration options: [Disabled] [L0s] [L1] [L0sL1] [Auto]

Port8xh Decode [Disabled]

Allows you to enable or PCI express port 8xh decode.
Configuration options: [Disabled] [Enabled]



The following item appears only when **Port8xh Decode** is set to **[Enabled]**.

Port8xh Decode Port# [0]

Select PCI Express Port8xh Decode Root Port. User to ensure port availability.
Configuration options: [0] - [23]

PCH Storage Configuration

SATA Controller(s) [Enabled]

Allows you to enable or disable the SATA Controller.
Configuration options: [Disabled] [Enabled]



The following items appear only when **SATA Controller(s)** is set to **[Enabled]**.

SATA Mode Selection [AHCI]

Allows you to select the SATA controllers operation.
Configuration options: [AHCI] [Intel RSTe Premium With Intel Optane System Acceleration]

SATA 1

Port 1 [Enabled]

Allows you to enable or disable the SATA port.

Configuration options: [Disabled] [Enabled]

SATA6G_1 Hot Plug [Disabled]

Allows you to enable or disable this port as hot pluggable.

Configuration options: [Disabled] [Enabled]

Spin Up Device [Disabled]

Allows you to enable or disable Spin Up Device. If enabled for any of the ports, Staggered Spin Up will be performed and only the drives which have this option enabled will spin up at boot. Otherwise all drives spin up at boot.

Configuration options: [Disabled] [Enabled]

SATA Device Type [Hard Disk Drive]

Allows you to identify the SATA port is connected to a solid state drive or a hard disk drive

Configuration options: [Hard Disk Drive] [Solid State Drive]

SATA 2

Port 2 [Enabled]

Allows you to enable or disable the SATA port.

Configuration options: [Disabled] [Enabled]

SATA6G_2 Hot Plug [Disabled]

Allows you to enable or disable this port as hot pluggable.

Configuration options: [Disabled] [Enabled]

Spin Up Device [Disabled]

Allows you to enable or disable Spin Up Device. If enabled for any of the ports, Staggered Spin Up will be performed and only the drives which have this option enabled will spin up at boot. Otherwise all drives spin up at boot.

Configuration options: [Disabled] [Enabled]

SATA Device Type [Hard Disk Drive]

Allows you to identify the SATA port is connected to a solid state drive or a hard disk drive

Configuration options: [Hard Disk Drive] [Solid State Drive]

SATA 3

Port 3 [Enabled]

Allows you to enable or disable the SATA port.

Configuration options: [Disabled] [Enabled]

SATA6G_3 Hot Plug [Disabled]

Allows you to enable or disable this port as hot pluggable.

Configuration options: [Disabled] [Enabled]

Spin Up Device [Disabled]

Allows you to enable or disable Spin Up Device. If enabled for any of the ports, Staggered Spin Up will be performed and only the drives which have this option enabled will spin up at boot. Otherwise all drives spin up at boot.

Configuration options: [Disabled] [Enabled]

SATA Device Type [Hard Disk Drive]

Allows you to identify the SATA port is connected to a solid state drive or a hard disk drive

Configuration options: [Hard Disk Drive] [Solid State Drive]

SATA 4**Port 1 [Enabled]**

Allows you to enable or disable the SATA port.

Configuration options: [Disabled] [Enabled]

SATA6G_4 Hot Plug [Disabled]

Allows you to enable or disable this port as hot pluggable.

Configuration options: [Disabled] [Enabled]

Spin Up Device [Disabled]

Allows you to enable or disable Spin Up Device. If enabled for any of the ports, Staggered Spin Up will be performed and only the drives which have this option enabled will spin up at boot. Otherwise all drives spin up at boot.

Configuration options: [Disabled] [Enabled]

SATA Device Type [Hard Disk Drive]

Allows you to identify the SATA port is connected to a solid state drive or a hard disk drive

Configuration options: [Hard Disk Drive] [Solid State Drive]

SATA 5**Port 5 [Enabled]**

Allows you to enable or disable the SATA port.

Configuration options: [Disabled] [Enabled]

SATA6G_5 Hot Plug [Disabled]

Allows you to enable or disable this port as hot pluggable.

Configuration options: [Disabled] [Enabled]

Spin Up Device [Disabled]

Allows you to enable or disable Spin Up Device. If enabled for any of the ports, Staggered Spin Up will be performed and only the drives which have this option enabled will spin up at boot. Otherwise all drives spin up at boot.

Configuration options: [Disabled] [Enabled]

SATA Device Type [Hard Disk Drive]

Allows you to identify the SATA port is connected to a solid state drive or a hard disk drive

Configuration options: [Hard Disk Drive] [Solid State Drive]

SATA 6**Port 6 [Enabled]**

Allows you to enable or disable the SATA port.

Configuration options: [Disabled] [Enabled]

SATA6G_6 Hot Plug [Disabled]

Allows you to enable or disable this port as hot pluggable.

Configuration options: [Disabled] [Enabled]

Spin Up Device [Disabled]

Allows you to enable or disable Spin Up Device. If enabled for any of the ports, Staggered Spin Up will be performed and only the drives which have this option enabled will spin up at boot. Otherwise all drives spin up at boot.

Configuration options: [Disabled] [Enabled]

SATA Device Type [Hard Disk Drive]

Allows you to identify the SATA port is connected to a solid state drive or a hard disk drive

Configuration options: [Hard Disk Drive] [Solid State Drive]

4.6 Security menu

This menu allows a new password to be created or a current password to be changed. The menu also enables or disables the Secure Boot state and lets the user configure the System Mode state.

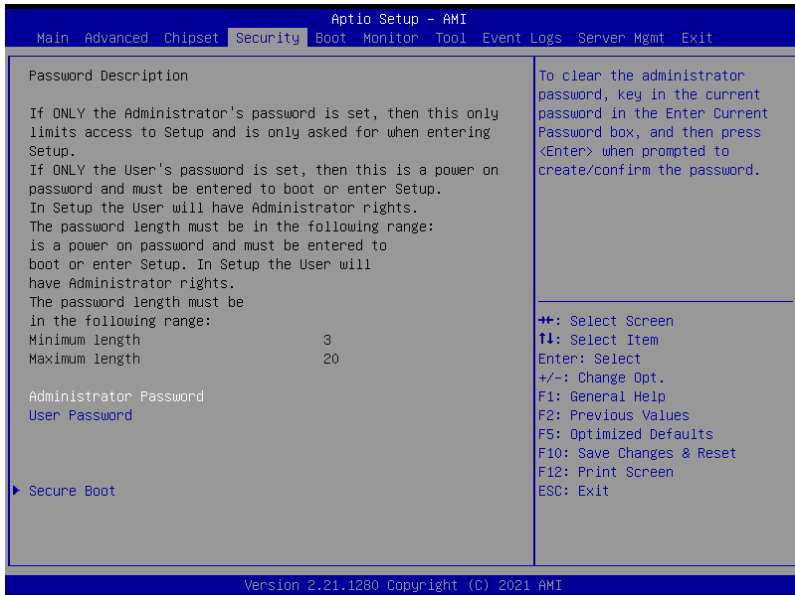

Administrator Password

To set an administrator password:

1. Select the Administrator Password item and press <Enter>.
2. From the Create New Password box, key in a password, then press <Enter>.
3. Confirm the password when prompted.

To change an administrator password:

1. Select the Administrator Password item and press <Enter>.
2. From the Enter Current Password box, key in the current password, then press <Enter>.
3. From the Create New Password box, key in a new password, then press <Enter>.
4. Confirm the password when prompted.



To clear the administrator password, follow the same steps as in changing an administrator password, but press <Enter> when prompted to create/confirm the password.

User Password

To set a user password:

1. Select the User Password item and press <Enter>.
2. From the Create New Password box, key in a password, then press <Enter>.
3. Confirm the password when prompted.

To change a user password:

1. Select the User Password item and press <Enter>.
2. From the Enter Current Password box, key in the current password, then press <Enter>.
3. From the Create New Password box, key in a new password, then press <Enter>.
4. Confirm the password when prompted.

To clear a user password:

1. Select the Clear User Password item and press <Enter>.
2. Select Yes from the Warning message window then press <Enter>.

Secure Boot

This item allows you to customize the Secure Boot settings.

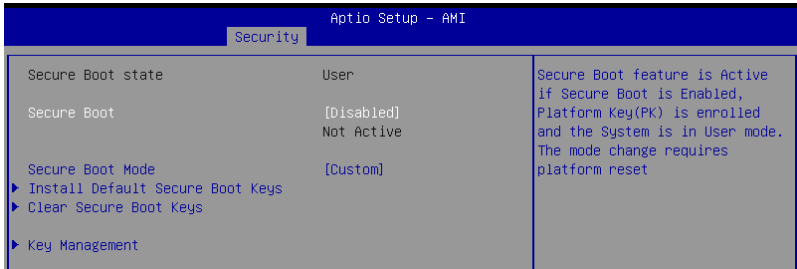

Secure Boot [Disabled]

Secure Boot feature is Active if Secure Boot is set to **[Enabled]**, Platform Key (PK) is enrolled and the System is in User mode. Mode change requires a platform reset.
Configuration options: [Disabled] [Enabled]

Secure Boot Mode [Custom]

Allows you to set the Secure Boot selector.
Configuration options: [Custom] [Standard]



The following items are available only when **Secure Boot Mode** is set to **[Custom]**.

Install Default Secure Boot Keys

This option will load the default secure boot keys, including the PK (Platform key), KEK (key-exchange key), db (signature database), and dbx (revoked signature database). All the secure boot keys states will change from unloaded to loaded. Save changes and reset the system for the changes to take effect.

Clear Secure Boot Keys

This option will delete all previously applied secure boot keys, including the PK (Platform key), KEK (key-exchange key), db (signature database), and dbx (revoked signature database). All the secure boot keys states will change from unloaded to loaded. Save changes and reset the system for the changes to take effect.

Key Management

This item only appears when the item **Secure Boot Mode** is set to **[Custom]**. The Key Management item allows you to modify Secure Boot variables and set Key Management page.

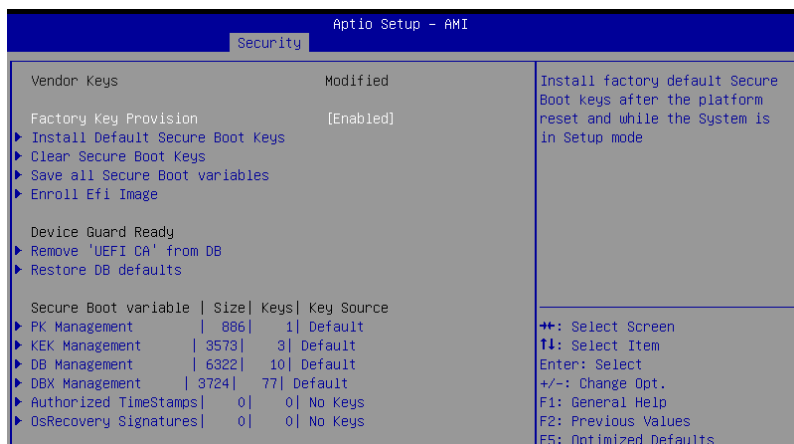

The screenshot shows the 'Security' menu in the Aptio Setup - AMI utility. The 'Factory Key Provision' is set to [Enabled]. The menu includes options for installing default keys, clearing keys, saving variables, and enrolling the EFI image. A table lists secure boot variables like PK, KEK, DB, and DBX Management with their sizes and key sources. A legend at the bottom right explains navigation keys like F1-F5.

Secure Boot variable	Size	Keys	Key Source
PK Management	886	1	Default
KEK Management	3573	3	Default
DB Management	6322	10	Default
DBX Management	3724	77	Default
Authorized TimeStamps	0	0	No Keys
OsRecovery Signatures	0	0	No Keys

Factory Key Provision [Enabled]

Allows you to provision factory default Secure Boot keys when the system is in Setup Mode.

Configuration options: [Disabled] [Enabled]

Install Default Secure Boot Keys

This option will load the default secure boot keys, including the PK (Platform key), KEK (key-exchange key), db (signature database), and dbx (revoked signature database). All the secure boot keys states will change from unloaded to loaded. Save changes and reset the system for the changes to take effect.

Clear Secure Boot Keys

This option will delete all previously applied secure boot keys, including the PK (Platform key), KEK (key-exchange key), db (signature database), and dbx (revoked signature database). All the secure boot keys states will change from unloaded to loaded. Save changes and reset the system for the changes to take effect.

Save all Secure Boot Variables

This option will save NVRAM content of Secure Boot policy variables to the file (EFI_SIGNATURE_LIST data format) in root folder on a target file system device.

Enroll Efi Image

This item will allow the image to run in Secure Boot mode. Enroll SHA256 Hash certificate of a PE image into Authorized Signature Database (db).

Device Guard Ready**Remove 'UEFI CA' from DB**

Remove Microsoft UEFI CA from Secure Boot DB.

Restore DB defaults

Restore DB variable to factory defaults.

PK Management

Configuration options: [Details] [Save To File] [Set New Key] [Delete key]

KEK Management / DB Management / DBX Management

Configuration options: [Details] [Save To File] [Set New Key] [Append Key] [Delete key]

Authorized TimeStamps / OsRecovery Signatures

Configuration options: [Set New Key] [Append Key]

4.7 Boot menu

The Boot menu items allow you to change the system boot options.

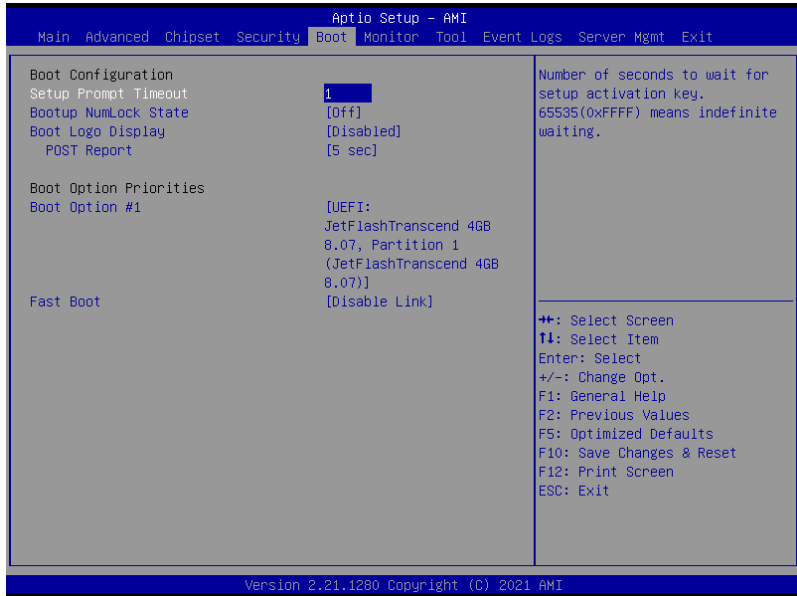

Setup Prompt Timeout [1]

Allows you to set the number of seconds that the firmware waits before initiating the original default boot selection. 65535(0xFFFF) means indefinite waiting. Use the <+> or <-> to adjust the value.

Bootup NumLock State [Off]

Allows you to select the power-on state for the NumLock.
Configuration options: [Off] [On]

Boot Logo Display [Disabled]

[Disabled] Hide the logo during POST.
[Enabled] Display the logo during POST.



The following item appears only when **Boot Logo Display** is set to **[Disabled]**.

POST Report [5 sec]

Allows you to set the desired POST Report waiting time from 1 to 10 seconds.
Configuration options: [1 sec] [3 sec] [5 sec] [10 sec] [Until Press ESC]

Boot Option Priorities

These items specify the boot device priority sequence from the available devices. The number of device items that appears on the screen depends on the number of devices installed in the system.



- To select the boot device during system startup, press <F8> when ASUS Logo appears.
- To access Windows OS in Safe Mode, please press <F8> after POST.

Fast Boot [Disable Link]

Allows you to enable or disable boot with initialization of a minimal set of devices required to launch active boot option. This has no effect for BBS boot options.

Configuration options: [Disable Link] [Enabled]



The following items appear only when **Fast Boot** is set to **[Enabled]**.

SATA Support [Last Boot SATA Devices Only]

[Last Boot SATA Devices Only] Only last booted SATA device will be available in POST.

[All SATA Devices] All SATA devices will be available in OS and POST.

NVMe Support [Enabled]

If this option is disabled, NVMe device will be skipped.

Configuration options: [Disable Link] [Enabled]

VGA Support [EFI Driver]

[Auto] Only legacy OpRom with Legacy OS, and logo will NOT be shown during POST.

[EFI Driver] Efi driver will still be installed with EFI OS.

USB Support [Full Intial]

[Disable Link] All USB devices will NOT be available until after OS boot.

[Full Initial] All USB devices will be available in OS and POST.

[Partial Initial] USB Mass Storage and specific USB port/device will NOT be available before OS boot.

PS2 Devices Support [Enabled]

If this option is disabled, PS2 devices will be skipped.

Configuration options: [Disable Link] [Enabled]

Network Stack Driver Support [Disable Link]

If this option is disabled, Network Stack Driver will be skipped.

Configuration options: [Disable Link] [Enabled]

Redirection Support [Disable Link]

If this option is disabled, Redirection function will be disabled.

Configuration options: [Disable Link] [Enabled]

4.8 Monitor menu

This menu displays the system temperature, fan speed, and power status. You can also change the fan settings in this menu.

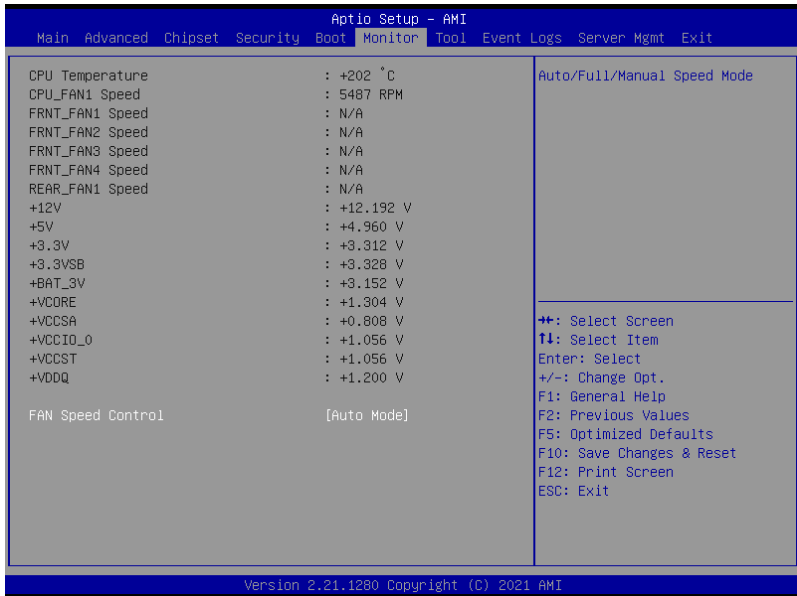

Fan Speed Control [Auto Mode]

Allows you to select the power-on state for the NumLock.

Configuration options: [Auto Mode] [Full Speed Mode] [Manual Speed Mode]



The following items appear only when **Fan Speed Control** is set to **[Manual Speed Mode]**.

REAR_FAN1 / CPU_FAN1 / FRNT_FAN1-4 Duty% [50]

Allows you to set the desired POST Report waiting time from 1 to 10 seconds. Use the <+> or <-> to adjust the value. The values range from 10 to 100.

4.9 Tool menu



Start ASUS EzFlash

Allows you to run ASUS EzFlash BIOS ROM Utility when you press <Enter>. Refer to the ASUS EzFlash Utility section for details.

ASUS SMBIOS Viewer

Allows you to start ASUS SMBIOS Viewer when you press <Enter>.

4.10 Event Logs menu

The Event Logs menu items allow you to change the event log settings and view the system event logs.

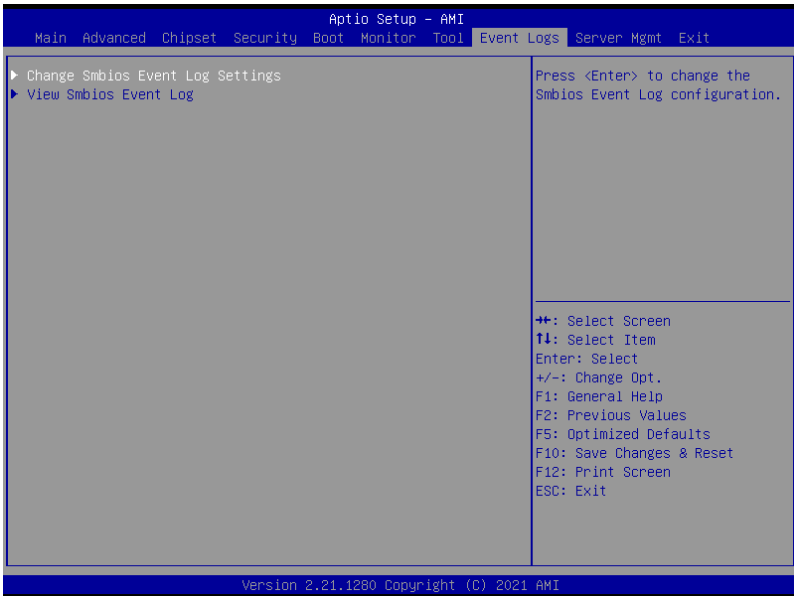

4.10.1 Change Smbios Event Log Settings

Press <Enter> to change the Smbios Event Log configuration.



All values changed here do not take effect until computer is restarted.

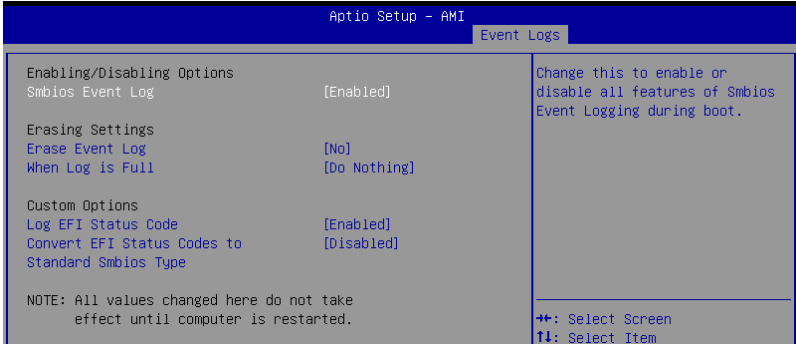

Enabling/Disabling Options

Smbios Event Log [Enabled]

Change this to enable or disable all features of Smbios Event Logging during boot.
Configuration options: [Disabled] [Enabled]



The following items appear only when **Smbios Event Log** is set to **[Enabled]**.

Erasing Settings

Erase Event Log [No]

Choose options for erasing Smbios Event Log. Erasing is done prior to any logging activation during reset.

Configuration options: [No] [Yes, Next reset] [Yes, Every reset]

When Log is Full [Do Nothing]

Choose options for reacting to a full Smbios Event Log.

Configuration options: [Do Nothing] [Erase Immediately]

Custom Options

Log EFI Status Code [Enabled]

This option allows you to enable or disable logging of the EFI Status Codes.

Configuration options: [Disabled] [Enabled]



The following item appears only when **Log EFI Status Code** is set to **[Enabled]**.

Convert EFI Status Codes to Standard Smbios Type [Disabled]

This option allows you to enable or disable converting of EFI Status Codes to Standard Smbios Type (Not all may be translated).

Configuration options: [Disabled] [Enabled]

4.10.2 View Smbios Event Log

Press <Enter> to view all smbios event logs.

Aptio Setup - AMI					Event Logs
DATE	TIME	ERROR CODE	SEVERITY	COUNT	DESCRIPTION
03/04/21	00:27:00	Event 0x16	N/A		Log Area Reset and Count is applicable only for Multi-Events
03/04/21	00:27:01	EFI 03008407	Unrecognized	04	
03/22/21	22:09:11	EFI 03008407	Unrecognized	01	

4.11 Server Mgmt menu



BMC Support [Enabled]

This item allows you to enable or disable interfaces to communicate with BMC.
Configuration options: [Disabled] [Enabled]



The following items appear only when **BMC Support** is set to **[Enabled]**.

OS Watchdog Timer [Disabled]

This item allows you to start a BIOS timer which can only be shut off by Management Software after the OS loads.
Configuration options: [Disabled] [Enabled]



The following items are configurable only when **OS Watchdog Timer** is set to **[Enabled]**.

OS Wtd Timer Timeout [10 minutes]

Allows you to configure the length for the OS Boot Watchdog Timer.
Configuration options: [5 minutes] [10 minutes] [15 minutes] [20 minutes]

OS Wtd Timer Policy [Reset]

This item allows you to configure the how the system should respond if the OS Boot Watch Timer expires.
Configuration options: [Do Nothing] [Reset] [Power Down] [Power Cycle]

BMC init phase [PEI phase]

Allows you to set BMC init phase.

Configuration options: [PEI phase] [BDS phase]

4.11.1 System Event Log

Allows you to change the SEL event log configuration.

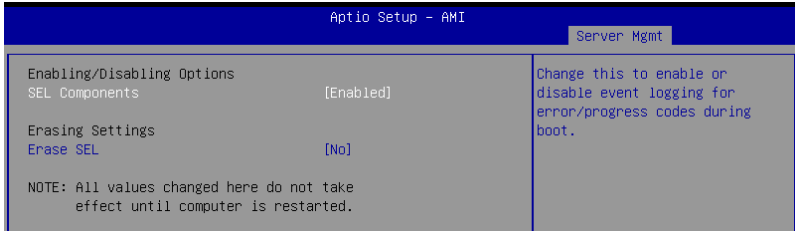

Enabling/Disabling Options

SEL Components [Enabled]

Allows you to enable or disable event logging for error/progress codes during boot.

Configuration options: [Disabled] [Enabled]



- The following items are configurable only when **SEL Components** is set to **[Enabled]**.
- All values changed here do not take effect until computer is restarted.

Erasing Settings

Erase SEL [No]

Allows you to choose options for erasing SEL.

Configuration options: [No] [Yes, On next reset] [Yes, On every reset]

4.11.2 View FRU information

Press <Enter> to view FRU information.

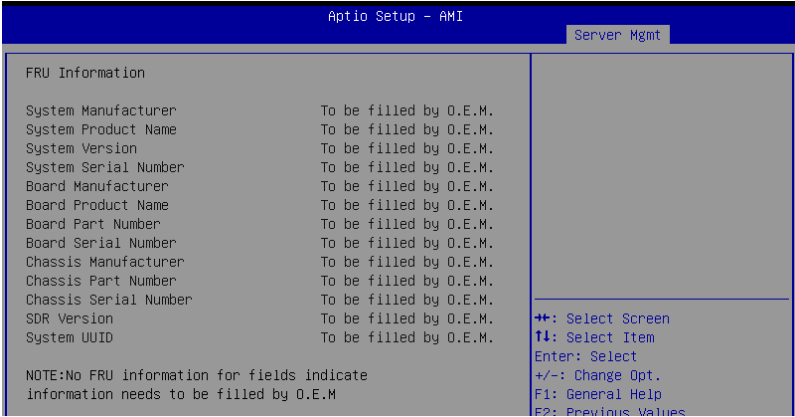

4.11.3 Bmc self test log

Allows you to change the SEL event log configuration.

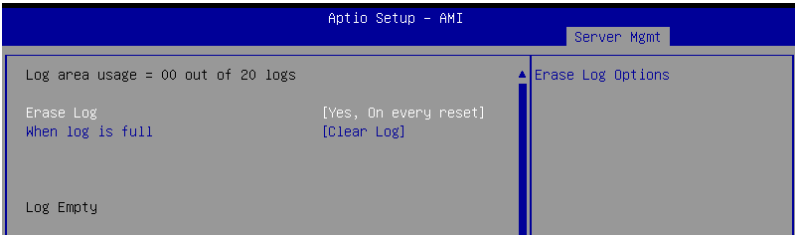

Erase Log [Yes, On every reset]

Choose options for erasing Smbios Event Log. Erasing is done prior to any logging activation during reset.

Configuration options: [No] [Yes, On every reset]

When Log is Full [Clear Log]

Allows you to choose options for reactions to a full Smbios Event Log.

Configuration options: [Clear Log] [Do not log any more]

4.11.4 BMC network configuration

The sub-items in this configuration allow you to configure the BMC network parameters.

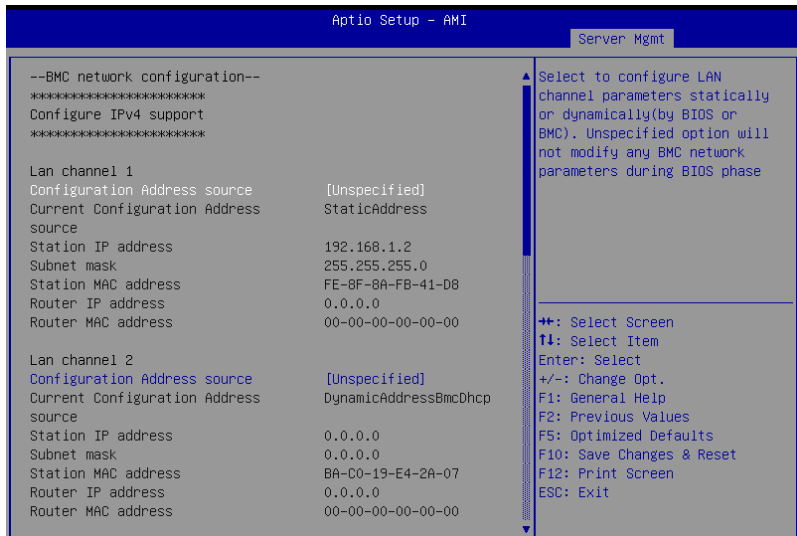

Navigate to the second page of the screen to see the rest of items in this menu by pressing the Up or Down arrow keys.



To quickly go to the last item of the second page, press the **Page Down** button. Press the **Page Up** button to go back to the first item in the first page.

Configure IPV4 support

Lan channel 1 / Lan channel 2

Configuration Address source [Unspecified]

Allows you to set the LAN channel parameters statically or dynamically (by BIOS or by BMC). **[Unspecified]** option will not modify any BMC network parameters during BIOS phase.

Configuration options: [Unspecified] [Static] [DynamicBmcDhcp]



The following items are available only when **Configuration Address source** is set to **[Static]**.

Station IP address

Allows you to set the station IP address.

Subnet mask

Allows you to set the subnet mask. We recommend that you use the same Subnet Mask you have specified on the operating system network for the used network card.

Router IP Address

Allows you to set the router IP address.

Router MAC Address

Allows you to set the router MAC address.

Configure IPV6 support

Lan channel 1 / Lan channel 2

IPV6 support [Enabled]

Allows you to enable or disable IPV6 support.

Configuration options: [Enabled] [Disabled]



The following items appear only when **IPV6 support** is set to **[Enabled]**.

Configuration Address source [Unspecified]

Allows you to set the LAN channel parameters statically or dynamically (by BIOS or by BMC). **[Unspecified]** option will not modify any BMC network parameters during BIOS phase.

Configuration options: [Unspecified] [Static] [DynamicBmcDhcp]



The following items are available only when **Configuration Address source** is set to **[Static]**.

Station IPV6 address

Allows you to set the station IPV6 address.

Prefix Length

Allows you to set the prefix length (maximum of Prefix Length is 128).

4.11.5 View System Event Log

This item allows you to view the system event log records.

Aptio Setup - AMI			Server Mgmt
No. of log entries in SEL : 4			HEX:
DATE	TIME	SENSOR TYPE	01 00 02 79 80 91
05/04/21	17:12:25	Temperature	60 20 00 04 01 01
05/04/21	17:12:25	Temperature	01 57 61 5E
05/04/21	17:12:37	Temperature	Generator ID: BMC - LUN #0 (Channel #0)
05/04/21	17:12:37	Temperature	Sensor Number: 0x01 Other
			Event Description:
			Record Type-0x02.
			Assertion Event.

4.12 Exit menu

The Exit menu items allow you to save or discard your changes to the BIOS items.

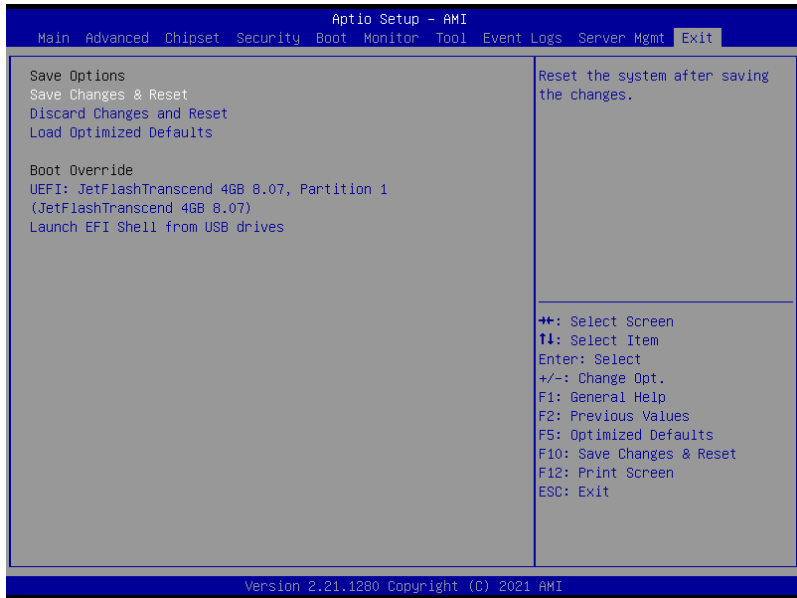

Pressing <Esc> does not immediately exit this menu. Select one of the options from this menu or <F10> from the legend bar to exit.

Save Changes and Reset

Reset system after saving the changes.

Discard Changes and Reset

Reset system setup without saving any changes.

Load Optimized Defaults

Restore/load default values for all the setup options.

Boot Override

These items displays the available devices. The device items that appears on the screen depends on the number of devices installed in the system. Click an item to start booting from the selected device.

RAID Configuration

5

This chapter provides instructions for setting up, creating, and configuring RAID sets using the available utilities.

5.1 Setting up RAID

The motherboard supports the Intel® Rapid Storage Technology enterprise Option ROM Utility with RAID 0, RAID 1, RAID 10, and RAID 5 support (for Windows OS and Linux).

5.1.1 RAID definitions

RAID 0 (Data striping) optimizes two identical hard disk drives to read and write data in parallel, interleaved stacks. Two hard disks perform the same work as a single drive but at a sustained data transfer rate, double that of a single disk alone, thus improving data access and storage. Use of two new identical hard disk drives is required for this setup.

RAID 1 (Data mirroring) copies and maintains an identical image of data from one drive to a second drive. If one drive fails, the disk array management software directs all applications to the surviving drive as it contains a complete copy of the data in the other drive. This RAID configuration provides data protection and increases fault tolerance to the entire system. Use two new drives or use an existing drive and a new drive for this setup. The new drive must be of the same size or larger than the existing drive.

RAID 10 is data striping and data mirroring combined without parity (redundancy data) having to be calculated and written. With the RAID 10 configuration you get all the benefits of both RAID 0 and RAID 1 configurations. Use four new hard disk drives or use an existing drive and three new drives for this setup.

RAID 5 stripes both data and parity information across three or more hard disk drives. Among the advantages of RAID 5 configuration include better HDD performance, fault tolerance, and higher storage capacity. The RAID 5 configuration is best suited for transaction processing, relational database applications, enterprise resource planning, and other business systems. Use a minimum of three identical hard disk drives for this setup.



If you want to boot the system from a hard disk drive included in a created RAID set, copy first the RAID driver from the support DVD to a floppy disk before you install an operating system to the selected hard disk drive.

5.1.2 Installing hard disk drives

The motherboard supports Serial ATA for RAID set configuration. For optimal performance, install identical drives of the same model and capacity when creating a disk array.

To install the SATA hard disks for RAID configuration:

1. Install the SATA hard disks into the drive bays following the instructions in the system user guide.
2. Connect a SATA signal cable to the signal connector at the back of each drive and to the SATA connector on the motherboard.
3. Connect a SATA power cable to the power connector on each drive.

5.1.3 Setting the RAID item in BIOS

You must set the RAID item in the BIOS Setup before you can create a RAID set from SATA hard disk drives attached to the SATA connectors supported by Intel® C242 chipset.

To do this:

1. Enter the BIOS Setup during POST.
2. Go to the **Chipset Menu > PCH Configuration > PCH Storage Configuration**, then press <Enter>.
3. Set **SATA Mode Selection** to **[Intel RSTe Premium With Intel Optane System Acceleration]**.
4. Press <F10> to save your changes and exit the BIOS Setup.



Refer to Chapter 4 for details on entering and navigating through the BIOS Setup.

5.2 Intel® Virtual Raid on CPU in BIOS

This feature allows you to do CPU RAID functions with Intel® CPU RSTe.

1. Enter the BIOS Setup during POST.
2. Go to the **Advanced** menu > **Intel(R) VROC SATA Controller** then press <Enter> to display the Intel® Virtual Raid on CPU menu.



Refer to Chapter 4 for details on entering and navigating through the BIOS Setup.

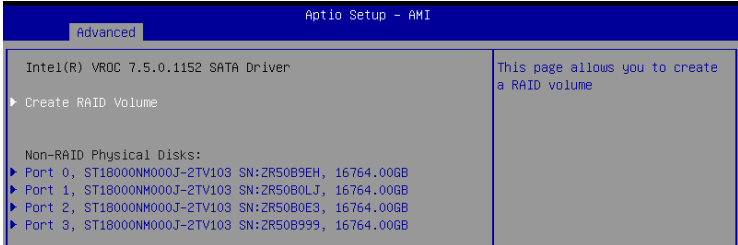

5.2.1 Creating a RAID set

To create a RAID set:

1. From the Intel® Virtual Raid on CPU menu, select **Create RAID Volume** and press <Enter>. The following screen appears:

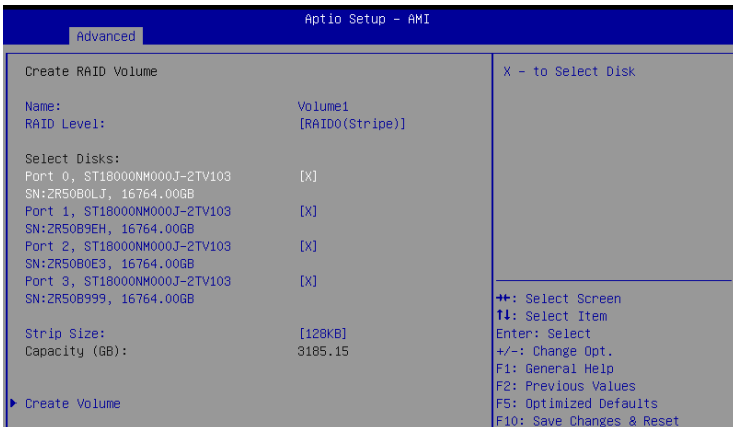

The screenshot shows the 'Advanced' menu in the Aptio Setup - AMI BIOS. The 'Create RAID Volume' screen is displayed with the following settings:

Name:	Volume1	X - to Select Disk
RAID Level:	[RAID0(Stripe)]	
Select Disks:		
Port 0, ST18000NH000J-2TV103 SN:ZR50B0LJ, 16764.00GB	[X]	
Port 1, ST18000NH000J-2TV103 SN:ZR50B9EH, 16764.00GB	[X]	
Port 2, ST18000NH000J-2TV103 SN:ZR50B0E3, 16764.00GB	[X]	
Port 3, ST18000NH000J-2TV103 SN:ZR50B999, 16764.00GB	[X]	
Strip Size:	[128KB]	++: Select Screen
Capacity (GB):	3185.15	F1: Select Item
		Enter: Select
		+/-: Change Opt.
		F1: General Help
		F2: Previous Values
		F5: Optimized Defaults
		F10: Save Changes & Reset

At the bottom left, there is a blue arrow pointing to the 'Create Volume' option.

2. When the **Name** item is selected, enter a name for the RAID set and press <Enter>.
3. When the **RAID Level** item is selected, press <Enter> to select the RAID level to create, and then press <Enter>.
4. Under **Select Disks**, press <Enter> and select **X** for the disks you want to include in the RAID set.
5. When the **Strip Size** item is selected, press <Enter> to select strip size for the RAID array (for RAID 0, 10 and 5 only), and then press <Enter>. The available strip size values range from 4 KB to 128 KB. The following are typical values:
 - RAID 0: 128 KB
 - RAID 10: 64 KB
 - RAID 5: 64 KB



We recommend a lower strip size for server systems, and a higher strip size for multimedia computer systems used mainly for audio and video editing.

7. When the **Capacity (GB)** item is selected, enter the RAID volume capacity that you want and press <Enter>. The default value indicates the maximum allowed capacity.
8. When the **Create Volume** item is selected, press <Enter> to create the RAID volume and return to the Intel® Rapid Storage Technology menu.

5.2.2 Deleting a RAID set



Be cautious when deleting a RAID set. You will lose all data on the hard disk drives when you delete a RAID set.

To delete a RAID set:

1. From the Intel® Virtual Raid on CPU menu, select the RAID volume you want to delete and press <Enter>. The following screen appears:

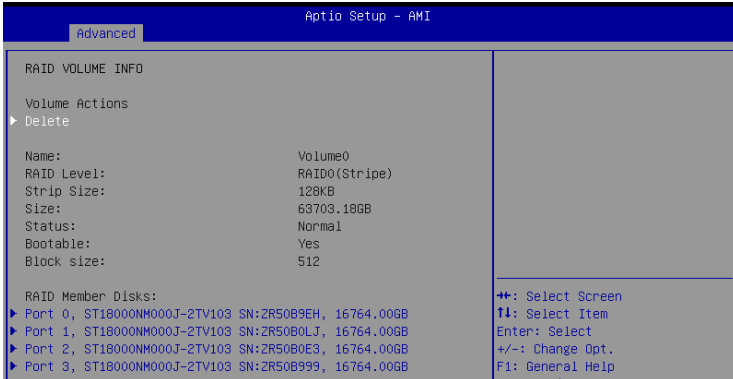

2. When the **Delete** item is selected, press <Enter>, then select **Yes** to delete the RAID volume and return to the Intel® Virtual Raid on CPU menu, or select **No** to cancel.

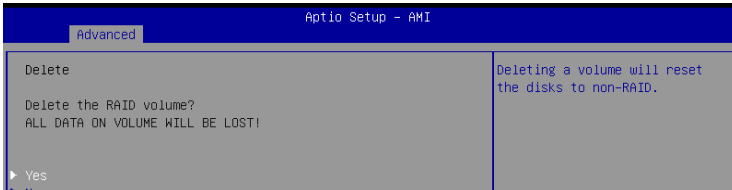

5.3 Intel® Rapid Storage Technology enterprise (Windows)

The Intel® Rapid Storage Technology enterprise allows you to create RAID 0, RAID 1, RAID 10 (RAID 1+0), and RAID 5 set(s) from Serial ATA hard disk drives that are connected to the Serial ATA connectors supported by the Southbridge.



You need to manually install the Intel® Rapid Storage Technology enterprise utility on a Windows® operating system. Please refer to the installation instructions in Chapter 6.

To enter the Intel® Rapid Storage Technology enterprise utility under Windows operating system:

1. Turn on the system and go to the windows desktop.
2. Click the **Intel(R) Virtual RAID on CPU** icon to display the main menu.

Your storage system is configured for data protection, increased performance and optimal data storage capacity. You can create additional volumes to further optimize your storage system.

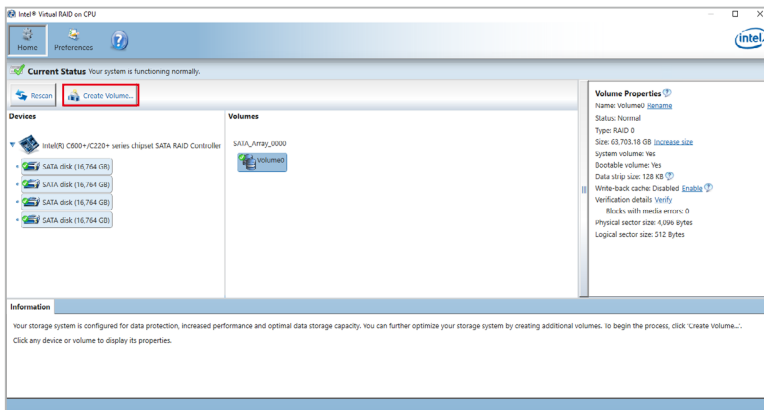

You can click **Rescan** to re-scan any attached hard disks.

5.3.1 Creating a RAID set

To create a RAID set:

1. From the utility main menu, select **Create Volume** and select volume type.
2. Click **Next**.

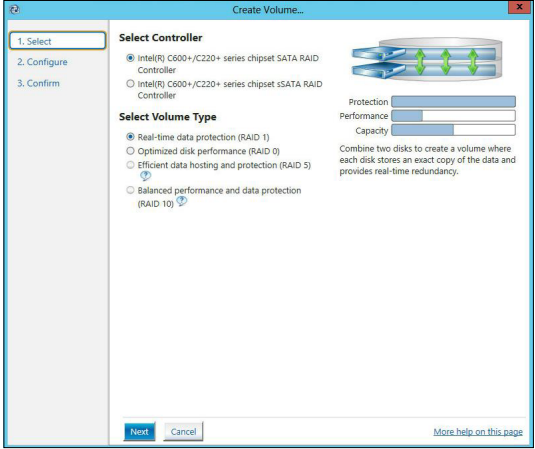

3. Enter a name for the RAID set, then select the array disks.
4. Select **Volume Size** tab, you can drag the bar to decide the volume size.
5. Click **Next**.

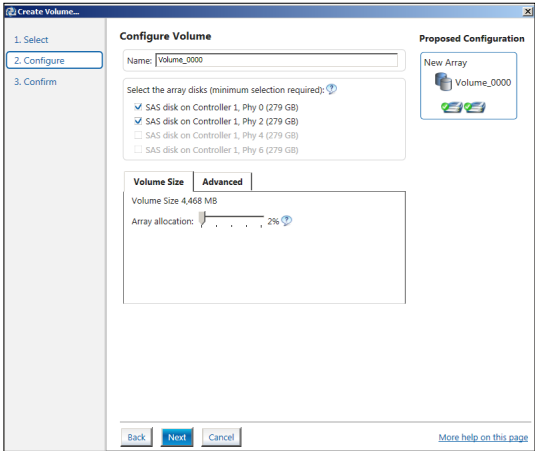

- If you do not want to keep the data on one of the selected disks, select **NO** when prompted.
- If you want to **Enable volume write-back cache** or **Initialize volume**, click **Advanced**.

6. Confirm the volume creation, then click **Create Volume** to continue.



This process could take a while depending on the number and size of the disks. You can continue using other applications during this time.

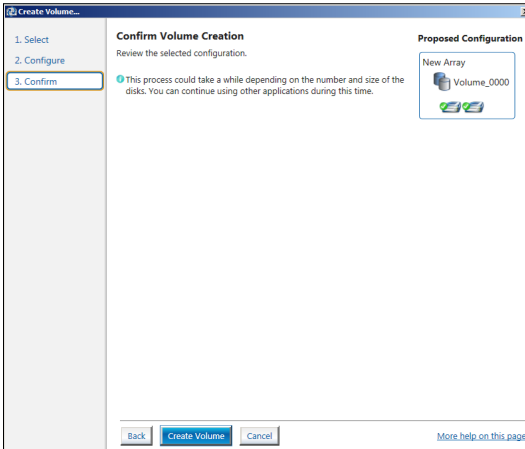

7. Wait until the process is completed, then click **OK** when prompted.

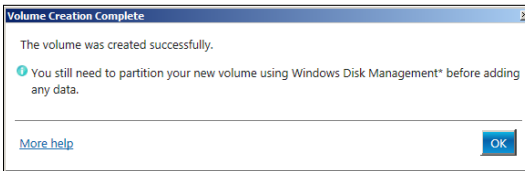

You still need to partition your new volume using Windows Disk Management before adding any data.

The RAID set is displayed in the **Volumes** list and you can change the settings in **Volume Properties**.

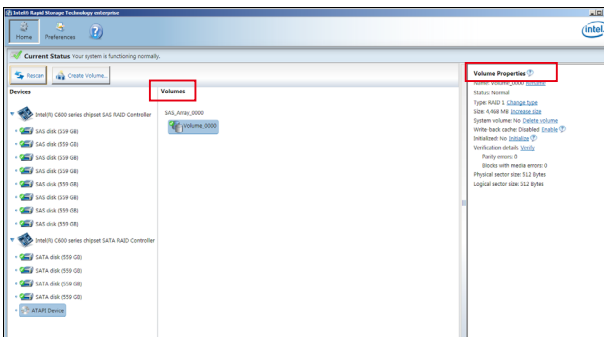

5.3.2 Changing a Volume Type

To change the volume type in **Volume Properties**:

1. Click the SATA array items you want to change in **Volumes** field.
2. From the **Volume Properties** field, select **Type:RAID 1 Change type**.

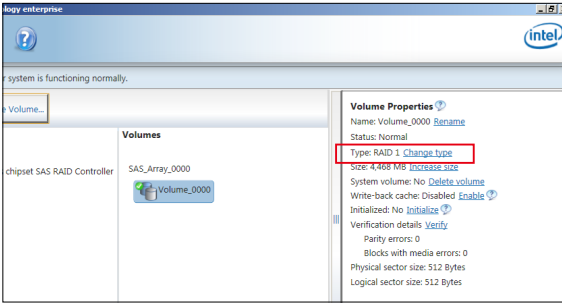

3. You can change the **Name**, **Select the new volume type**, and **Select additional disks to include in the new volume** if needed.
4. Select the **Data stripe size** for the RAID array (for RAID 0, 10 and 5 only), and click **OK**. The available stripe size values range from 4 KB to 128 KB. The following are typical values:
RAID 0: 128KB
RAID 10: 64KB
RAID 5: 64KB

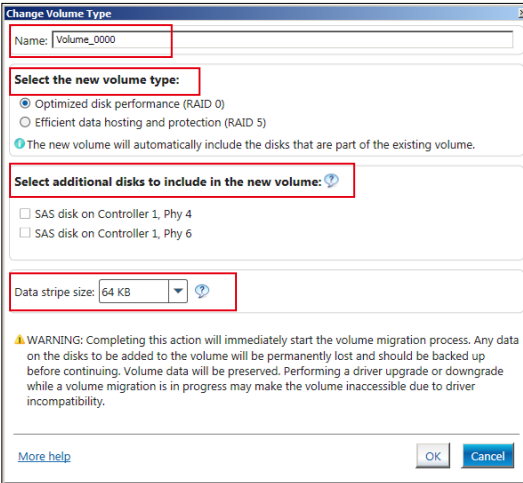

We recommend a lower stripe size for server systems, and a higher stripe size for multimedia computer systems used mainly for audio and video editing.

5.3.3 Deleting a volume



Be cautious when deleting a volume. You will lose all data on the hard disk drives. Before you proceed, ensure that you back up all your important data from your hard drives.

To delete a volume:

1. From the utility main menu, select the volume (exp. Volume_0000) in **Volumes** field you want to delete.

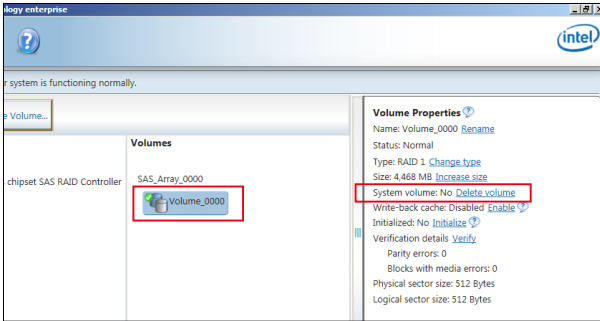

2. Select **Delete volume** in **Volume Properties** field. The following screen appears.

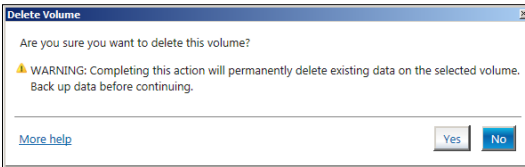

3. Click **Yes** to delete the volume and return to the utility main menu, or click **No** to return to the main menu.

5.3.4 Preferences

System Preferences

Allow you to set to show the notification area icon and show system information, warning, or errors here.

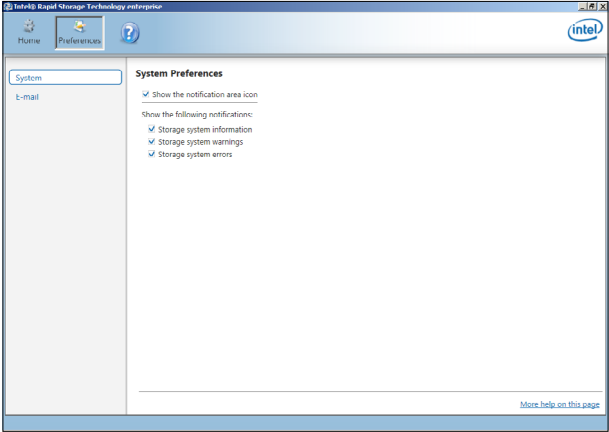

E-Mail Preferences

Allow you to set to sent e-mail of the following events:

- Storage system information
- Storage system warnings
- Storage system errors

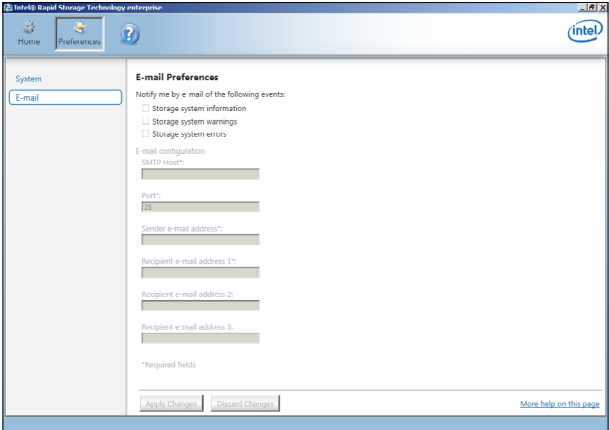

Driver Installation

6

This chapter provides the instructions for installing the necessary drivers for different system components in both Linux[®] and Windows[®] Operating Systems.

6.1 RAID driver installation

After creating the RAID sets for your server system, you are now ready to install an operating system to the independent hard disk drive or bootable array. This part provides the instructions on how to install the RAID controller drivers during OS installation.

6.1.1 Creating a USB flash drive with RAID drive

When installing Windows® Server OS, you can load the RAID driver from a USB flash drive. You can create a USB flash drive with RAID driver in Windows by copying the files from the support DVD to the USB flash drive.

To copy the RAID driver to a USB flash drive in Windows environment:

1. Place the motherboard support DVD in the optical drive.
2. Connect a USB flash drive to your system.
3. Click on the optical drive to browse the contents of the support DVD.
4. Click **Drivers > C25x INTEL RAID > Windows > Driver** and then copy the RAID driver folder to the USB flash drive.

6.1.2 Installing the RAID controller driver

During Windows® Server 2012 R2, 2016, or 2019 OS installation

To install the RAID controller driver when installing Windows® Server OS:

1. Boot the computer using the Windows® Server installation disc. Follow the onscreen instructions to start installing Windows® Server.
2. When prompted to choose a type of installation, click **Custom: Install Windows only (advanced)**.

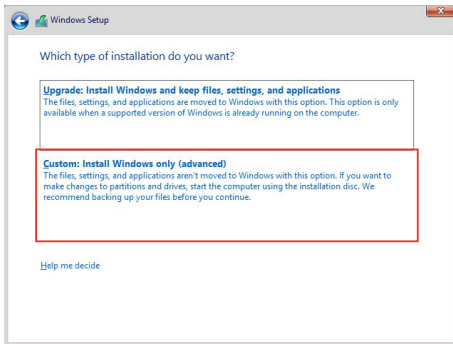

3. Click **Load Driver**.

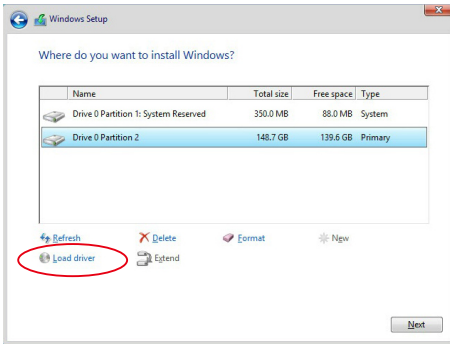

4. A message appears reminding you to insert the installation media containing the driver of the RAID controller driver (the installation media can be a CD, DVD, or USB flash drive).
- If you have only one optical drive installed in your system, eject the Windows OS installation disc and replace with the motherboard Support DVD into the optical drive.
 - Or you may connect a USB flash drive containing the RAID controller driver.

Click **Browse** to continue.

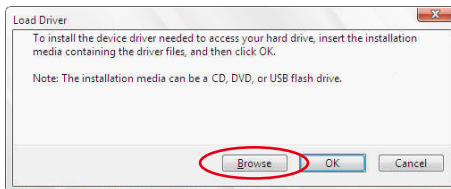

5. Locate the driver in the corresponding folder of the Support DVD or USB flash drive and then click **OK** to continue.
6. Select the RAID controller driver you need from the list and click **Next**.

7. When the system finishes loading the RAID driver,
 - Replace the motherboard Support DVD with the Windows Server installation disc.
 - Remove the USB flash drive.

Select the drive to install Windows and click **Next**.

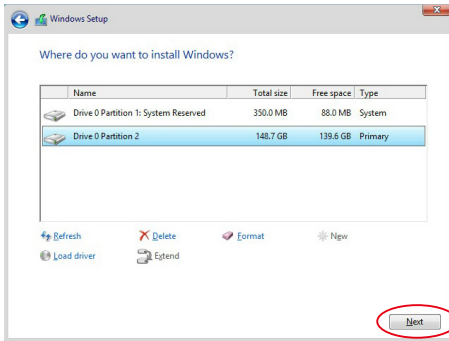

8. Setup then proceeds with the OS installation. Follow the onscreen instructions to continue.

6.2 Running the Support DVD

The support DVD that is bundled with your motherboard contains drivers, management applications, and utilities that you can install to maximize the features of your motherboard.



The contents of the support DVD are subject to change at any time without notice. Visit the ASUS website (www.asus.com) for the latest updates on software and utilities.

The main screen of the Support DVD contains the following tabs:

1. Drivers - Shows the available device drivers that the system detects.
2. Utilities - Displays the software applications and utilities that the motherboard supports.
3. Manual - Provides the link to the user guide(s).



You need an internet browser installed in your OS to view the User Guide.

4. Contact - Displays the ASUS contact information, e-mail addresses, and useful links if you need more information or technical support for your motherboard.

Appendix

This appendix includes additional information that you may refer to when configuring the motherboard.

P12R-M Series block diagram

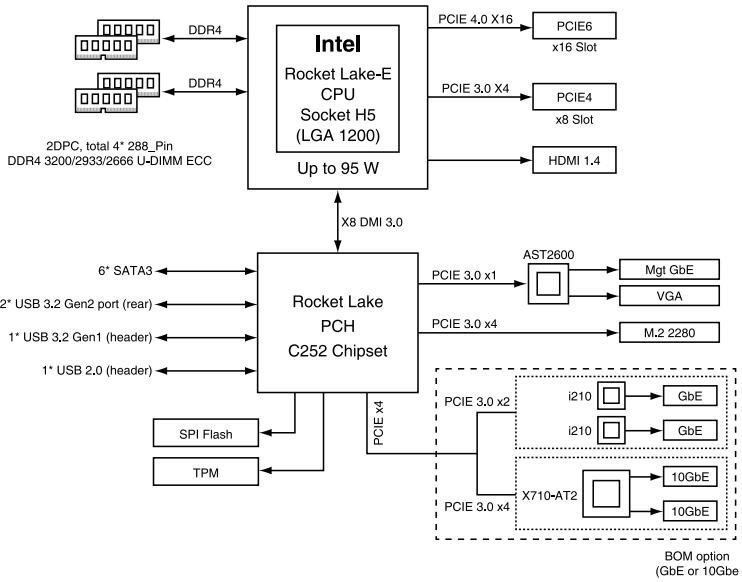

Q-Code table

Action	PHASE	POST CODE	TYPE	DESCRIPTION	
SEC Start up	Security Phase	0x1	Progress	First post code	
		0x2	Progress	Load BSP microcode	
		0x3	Progress	Perform early platform Initialization	
		0x4	Progress	Set cache as ram for PEI phase	
		0x5	Progress	Establish Stack	
		0x6	Progress	CPU Early Initialization	
Quick VGA	PEI(Pre-EFI Initialization) phase	0x10	Progress	PEI Core Entry	
		0x11	Progress	PEI cache as ram CPU initial	
		0x15	Progress	NB Initialization before installed memory	
		0x19	Progress	SB Initialization before installed memory	
		MRC Progress phase	0xB0	MRC Progress	DIMM detect
			0xB1	MRC Progress	DIMM clock Initialization
	0xB2		MRC Progress	DIMM SPD data Initialization	
	0xB3		MRC Progress	DIMM global early	
	0xB4		MRC Progress	DIMM rank detect	
	0xB5		MRC Progress	DIMM channel early	
	0xB6		MRC Progress	DIMM DDRIO Initialization	
	0xB7		MRC Progress	DIMM channel training	
	0xB8		MRC Progress	DIMM Initialization throttling	
	0xB9		MRC Progress	memory BIST	
	0xBA		MRC Progress	MEM memory Initialization	
	0xBB		MRC Progress	DIMM DDR memory map	
	0xBC		MRC Progress	RAS configuration	
	0xBD		MRC Progress	Get Margins	
	0xBE	MRC Progress	Memory SSA api Initialization		
	0xBF	MRC Progress	MRC done		
	DXE(Driver Execution Environment) phase	Quick VGA	0x32	Progress	CPU POST-Memory Initialization
			0x33	Progress	CPU Cache Initialization
			0x34	Progress	Application Processor(s) (AP) Initialization
			0x35	Progress	BSP Selection
			0x36	Progress	CPU Initialization
			0x37	Progress	Pre-memory NB Initialization
			0x3B	Progress	Pre-memory SB Initialization
			0x4F	Progress	DXE Initial Program Load(IPL)
			0x60	Progress	DXE Core Started
			0x61	Progress	DXE NVRAM Initialization
			0x62	Progress	SB run-time Initialization
			0x63	Progress	CPU DXE Initialization
			0x68	Progress	PCI HB Initialization
			0x69	Progress	NB DXE Initialization
			0x6A	Progress	NB DXE SMM Initialization
		0x70	Progress	SB DXE Initialization	
		0x71	Progress	SB DXE SMM Initialization	
		0x72	Progress	SB DEVICES Initialization	
		0x78	Progress	ACPI Module Initialization	
		0x79	Progress	CSM Initialization	
		0xD0	Progress	CPU PM Structure Initialization	
		0xD1	Progress	CPU PM CSR programming	
		0xD2	Progress	CPU PM MSR programming	
		0xD3	Progress	CPU PM PSTATE transition	
		0xD4	Progress	CPU PM driver exit	
0xD5		Progress	CPU PM On ready to boot event		

(continued on the next page)

Action	PHASE	POST CODE	TYPE	DESCRIPTION
Normal boot	BDS (Boot Device Selection) phase	0x90	Progress	BDS started
		0x91	Progress	Connect device event
		0x92	Progress	PCI Bus Enumeration
		0x93	Progress	PCI Bus Enumeration
		0x94	Progress	PCI Bus Enumeration
		0x95	Progress	PCI Bus Enumeration
		0x96	Progress	PCI Bus Enumeration
		0x97	Progress	Console output connect event
		0x98	Progress	Console input connect event
		0x99	Progress	AMI Super IO start
		0x9A	Progress	AMI USB Driver Initialization
		0x9B	Progress	AMI USB Driver Initialization
		0x9C	Progress	AMI USB Driver Initialization
		0x9D	Progress	AMI USB Driver Initialization
		0xb2	Progress	Legacy Option ROM Initialization
		0xb3	Progress	Reset system
		0xb4	Progress	USB hotplug
		0xb6	Progress	NVRAM clean up
		0xb7	Progress	NVRAM configuration reset
		0xA0	Progress	IDE, AHCI Initialization
		0xA1	Progress	IDE, AHCI Initialization
		0xA2	Progress	IDE, AHCI Initialization
		0xA3	Progress	IDE, AHCI Initialization
		0x00-0xFF	Progress	Wait BMC ready
		0xA8	Progress	BIOS Setup Utility password verify
		0xA9	Progress	BIOS Setup Utility start
		0xAB	Progress	BIOS Setup Utility input wait
		0xAD	Progress	Ready to boot event
	0xAE	Progress	Legacy boot event	
	Operating system phase	0xAA	Progress	APIC mode
		0xAC	Progress	PIC mode

Notices

Federal Communications Commission Statement

This device complies with Part 15 of the FCC Rules. Operation is subject to the following two conditions:

- This device may not cause harmful interference, and
- This device must accept any interference received including interference that may cause undesired operation.

This equipment has been tested and found to comply with the limits for a Class B digital device, pursuant to Part 15 of the FCC Rules. These limits are designed to provide reasonable protection against harmful interference in a residential installation. This equipment generates, uses and can radiate radio frequency energy and, if not installed and used in accordance with manufacturer's instructions, may cause harmful interference to radio communications. However, there is no guarantee that interference will not occur in a particular installation. If this equipment does cause harmful interference to radio or television reception, which can be determined by turning the equipment off and on, the user is encouraged to try to correct the interference by one or more of the following measures:

- Reorient or relocate the receiving antenna.
- Increase the separation between the equipment and receiver.
- Connect the equipment to an outlet on a circuit different from that to which the receiver is connected.
- Consult the dealer or an experienced radio/TV technician for help.



The use of shielded cables for connection of the monitor to the graphics card is required to assure compliance with FCC regulations. Changes or modifications to this unit not expressly approved by the party responsible for compliance could void the user's authority to operate this equipment.

Compliance Statement of Innovation, Science and Economic Development Canada (ISED)

This device complies with Innovation, Science and Economic Development Canada licence exempt RSS standard(s). Operation is subject to the following two conditions: (1) this device may not cause interference, and (2) this device must accept any interference, including interference that may cause undesired operation of the device.

CAN ICES-003(B)/NMB-003(B)

Déclaration de conformité de Innovation, Sciences et Développement économique Canada (ISED)

Le présent appareil est conforme aux CNR d'Innovation, Sciences et Développement économique Canada applicables aux appareils radio exempts de licence. L'exploitation est autorisée aux deux conditions suivantes : (1) l'appareil ne doit pas produire de brouillage, et (2) l'utilisateur de l'appareil doit accepter tout brouillage radioélectrique subi, même si le brouillage est susceptible d'en compromettre le fonctionnement.

CAN ICES-003(B)/NMB-003(B)

Australia statement notice

From 1 January 2012 updated warranties apply to all ASUS products, consistent with the Australian Consumer Law. For the latest product warranty details please visit <https://www.asus.com/support>. Our goods come with guarantees that cannot be excluded under the Australian Consumer Law. You are entitled to a replacement or refund for a major failure and compensation for any other reasonably foreseeable loss or damage. You are also entitled to have the goods repaired or replaced if the goods fail to be of acceptable quality and the failure does not amount to a major failure.

If you require assistance please call ASUS Customer Service 1300 2787 88 or visit us at <https://www.asus.com/support>

Declaration of compliance for product environmental regulation

ASUS follows the green design concept to design and manufacture our products, and makes sure that each stage of the product life cycle of ASUS product is in line with global environmental regulations. In addition, ASUS disclose the relevant information based on regulation requirements.

Please refer to <http://csr.asus.com/Compliance.htm> for information disclosure based on regulation requirements ASUS is complied with:

EU REACH and Article 33

Complying with the REACH (Registration, Evaluation, Authorization, and Restriction of Chemicals) regulatory framework, we publish the chemical substances in our products at ASUS REACH website at <http://csr.asus.com/english/REACH.htm>.

EU RoHS

This product complies with the EU RoHS Directive. For more details, see <http://csr.asus.com/english/article.aspx?id=35>

India RoHS

This product complies with the “India E-Waste (Management) Rules, 2016” and prohibits use of lead, mercury, hexavalent chromium, polybrominated biphenyls (PBBs) and polybrominated diphenyl ethers (PBDEs) in concentrations exceeding 0.1% by weight in homogenous materials and 0.01% by weight in homogenous materials for cadmium, except for the exemptions listed in Schedule II of the Rule.

Vietnam RoHS

ASUS products sold in Vietnam, on or after September 23, 2011, meet the requirements of the Vietnam Circular 30/2011/TT-BCT.

Các sản phẩm ASUS bán tại Việt Nam, vào ngày 23 tháng 9 năm 2011 trở về sau, đều phải đáp ứng các yêu cầu của Thông tư 30/2011/TT-BCT của Việt Nam.

Turkey RoHS

AEEE Yönetmeliğine Uygundur

ASUS Recycling/Takeback Services

ASUS recycling and takeback programs come from our commitment to the highest standards for protecting our environment. We believe in providing solutions for you to be able to responsibly recycle our products, batteries, other components as well as the packaging materials. Please go to <http://csr.asus.com/english/Takeback.htm> for detailed recycling information in different regions.



DO NOT throw the motherboard in municipal waste. This product has been designed to enable proper reuse of parts and recycling. This symbol of the crossed out wheeled bin indicates that the product (electrical and electronic equipment) should not be placed in municipal waste. Check local regulations for disposal of electronic products.



DO NOT throw the mercury-containing button cell battery in municipal waste. This symbol of the crossed out wheeled bin indicates that the battery should not be placed in municipal waste.

Japan statement notice

This product cannot be directly connected to the Internet (including public wireless LAN) of a telecom carrier (mobile network companies, landline network companies, Internet providers, etc.). When connecting this product to the Internet, be sure to connect it through a router or switch.

Japan JATE

本製品は電気通信事業者（移動通信会社、固定通信会社、インターネットプロバイダ等）の通信回線（公衆無線LANを含む）に直接接続することができません。本製品をインターネットに接続する場合は、必ずルーター等を経由し接続してください。

Simplified UKCA Declaration of Conformity

ASUSTeK Computer Inc. hereby declares that this device is in compliance with the essential requirements and other relevant provisions of related Regulations. Full text of UKCA declaration of conformity is available at: www.asus.com/support

Simplified EU Declaration of Conformity

English ASUSTeK Computer Inc. hereby declares that this device is in compliance with the essential requirements and other relevant provisions of related Directives. Full text of EU declaration of conformity is available at: www.asus.com/support

Français ASUSTeK Computer Inc. déclare par la présente que cet appareil est conforme aux critères essentiels et autres clauses pertinentes des directives concernées. La déclaration de conformité de l'UE peut être téléchargée à partir du site Internet suivant : www.asus.com/support

Deutsch ASUSTeK Computer Inc. erklärt hiermit, dass dieses Gerät mit den wesentlichen Anforderungen und anderen relevanten Bestimmungen der zugehörigen Richtlinien übereinstimmt. Der gesamte Text der EU-Konformitätserklärung ist verfügbar unter: www.asus.com/support

Italiano ASUSTeK Computer Inc. con la presente dichiara che questo dispositivo è conforme ai requisiti essenziali e alle altre disposizioni pertinenti con le direttive correlate. Il testo completo della dichiarazione di conformità UE è disponibile all'indirizzo: www.asus.com/support

Русский Компания ASUS заявляет, что это устройство соответствует основным требованиям и другим соответствующим условиям соответствующих директив. Подробную информацию, пожалуйста, смотрите на www.asus.com/support

Български С настоящото ASUSTeK Computer Inc. декларира, че това устройство е в съответствие със съществените изисквания и другите приложими постановления на свързаните директиви. Пълният текст на декларацията за съответствие на ЕС е достъпна на адрес: www.asus.com/support

Hrvatski ASUSTeK Computer Inc. ovim izjavljuje da je ovaj uređaj sukladan s bitnim zahtjevima i ostalim odgovarajućim odredbama vezanih direktiva. Cijeli tekst EU izvje o sukladnosti dostupan je na: www.asus.com/support

Čeština Společnost ASUSTeK Computer Inc. tímto prohlašuje, že toto zařízení splňuje základní požadavky a další příslušná ustanovení souvisejících směrnic. Plné znění prohlášení o shodě EU je k dispozici na adrese: www.asus.com/support

Dansk ASUSTeK Computer Inc. erklærer hermed, at denne enhed er i overensstemmelse med hovedkravene og andre relevante bestemmelser i de relaterede direktiver. Hele EU-overensstemmelseserklæringen kan findes på: www.asus.com/support

Nederlands ASUSTeK Computer Inc. verklaart hierbij dat dit apparaat voldoet aan de essentiële vereisten en andere relevante bepalingen van de verwante richtlijnen. De volledige tekst van de EU-verklaring van conformiteit is beschikbaar op: www.asus.com/support

Eesti Käesolevaga kinnitab ASUSTeK Computer Inc, et see seade vastab asjakohaste direktiivide oluliste nõuetele ja teistele asjassepuutuvatele sätetele. EL vastavusdeklaratsiooni täielik tekst on saadaval järgmisel aadressil: www.asus.com/support

Suomi ASUSTeK Computer Inc. ilmoittaa täten, että tämä laite on asiaankuuluvien direktiivien olennaisten vaatimusten ja muiden tätä koskevien säädösten mukainen. EU-yhdenmukaisuusilmoituksen koko teksti on luettavissa osoitteessa: www.asus.com/support

Ελληνικά Με το παρόν, η AsusTek Computer Inc. δηλώνει ότι αυτή η συσκευή συμμορφώνεται με τις θεμελιώδεις απαιτήσεις και άλλες σχετικές διατάξεις των Οδηγίων της ΕΕ. Το πλήρες κείμενο της δηλώσης συμβατότητας είναι διαθέσιμο στη διεύθυνση: www.asus.com/support

Magyar Az ASUSTeK Computer Inc. ezennel kijelenti, hogy ez az eszköz megfelel a kapcsolódó Irányelvek lényeges követelményeinek és egyéb vonatkozó rendelkezéseinek. Az EU megfeleléségi nyilatkozat teljes szövege innen letölthető: www.asus.com/support

Latviski ASUSTeK Computer Inc. ar šo paziņo, ka šī ierīce atbilst saistīto Direktīvu būtiskajām prasībām un citiem citiem saistošajiem nosacījumiem. Pilns ES atbilstības paziņojuma teksts pieejams šeit: www.asus.com/support

Lietuvių „ASUSTeK Computer Inc.“ šiuo tvirtina, kad šis įrenginys atitinka pagrindinius reikalavimus ir kitas svarbias susijusių direktyvų nuostatas. Visą ES atitikties deklaracijos tekstą galima rasti: www.asus.com/support

Norsk ASUSTeK Computer Inc. erklærer herved at denne enheten er i samsvar med hovedsaklige krav og andre relevante forskrifter i relaterte direktiver. Fullstendig tekst for EU-samsvarserklæringen finnes på: www.asus.com/support

Polski Firma ASUSTeK Computer Inc. niniejszym oświadcza, że urządzenie to jest zgodne z zasadniczymi wymogami i innymi właściwymi postanowieniami powiązanych dyrektyw. Pełny tekst deklaracji zgodności UE jest dostępny pod adresem: www.asus.com/support

Português A ASUSTeK Computer Inc. declara que este dispositivo está em conformidade com os requisitos essenciais e outras disposições relevantes das Diretivas relacionadas. Texto integral da declaração da UE disponível em: www.asus.com/support

Română ASUSTeK Computer Inc. declară că acest dispozitiv se conformează cerințelor esențiale și altor prevederi relevante ale directivei conexe. Textul complet al declarației de conformitate a Uniunii Europene se găsește la: www.asus.com/support

Srpski ASUSTeK Computer Inc. ovim izjavljuje da je ovaj uređaj u saglasnosti sa osnovnim zahtevima i drugim relevantnim odredbama povezanih Direktiva. Pun tekst EU deklaracije o usaglašenosti je dostupan da adresi: www.asus.com/support

Slovensky Spoločnosť ASUSTeK Computer Inc. týmto vyhlasuje, že toto zariadenie vyhovuje základným požiadavkám a ostatým príslušným ustanoveniam príslušných smerníc. Celý text vyhlásenia o zhode pre štáty EÚ je dostupný na adrese: www.asus.com/support

Slovenščina ASUSTeK Computer Inc. izjavlja, da je ta naprava skladna z bistvenimi zahtevami in drugimi ustreznimi določbami povezanih direktiv. Celotno besedilo EU-izjave o skladnosti je na voljo na spletnem mestu: www.asus.com/support

Español Por la presente, ASUSTeK Computer Inc. declara que este dispositivo cumple los requisitos básicos y otras disposiciones pertinentes de las directivas relacionadas. El texto completo de la declaración de la UE de conformidad está disponible en: www.asus.com/support

Svenska ASUSTeK Computer Inc. förklarar härmed att denna enhet överensstämmer med de grundläggande kraven och andra relevanta föreskrifter i relaterade direktiv. Fulltext av EU-försäkran om överensstämmelse finns på: www.asus.com/support

Українська ASUSTeK Computer Inc. заявляє, що цей пристрій відповідає основним вимогам та іншим відповідним положенням відповідних Директив. Повний текст декларації відповідності стандартам ЄС доступний на: www.asus.com/support

Türkçe AsusTek Computer Inc., bu aygıtın temel gereksinimlerle ve ilişkili Yönergelerin diğer ilgili koşullarıyla uyumlu olduğunu beyan eder. AB uygunluk bildiriminin tam metni şu adreste bulunabilir: www.asus.com/support

Bosanski ASUSTeK Computer Inc. ovim izjavljuje da je ovaj uređaj usklađen sa bitnim zahtjevima i ostalim odgovarajućim odredbama vezanih direktiva. Cijeli tekst EU izjave o usklađenosti dostupan je na: www.asus.com/support

Service and Support

Visit our multi-language website at <https://www.asus.com/support>.



FCC COMPLIANCE INFORMATION

Per FCC Part 2 Section 2.1077



Responsible Party: Asus Computer International
Address: 48720 Kato Rd, Fremont, CA 94538
Phone/Fax No: (510)739-3777/(510)608-4555

hereby declares that the product

Product Name : Motherboard
Model Number : P12R-M;P12R-M/10G-2T

compliance statement:

This device complies with part 15 of the FCC Rules. Operation is subject to the following two conditions: (1) This device may not cause harmful interference, and (2) this device must accept any interference received, including interference that may cause undesired operation.

Ver. 180620