

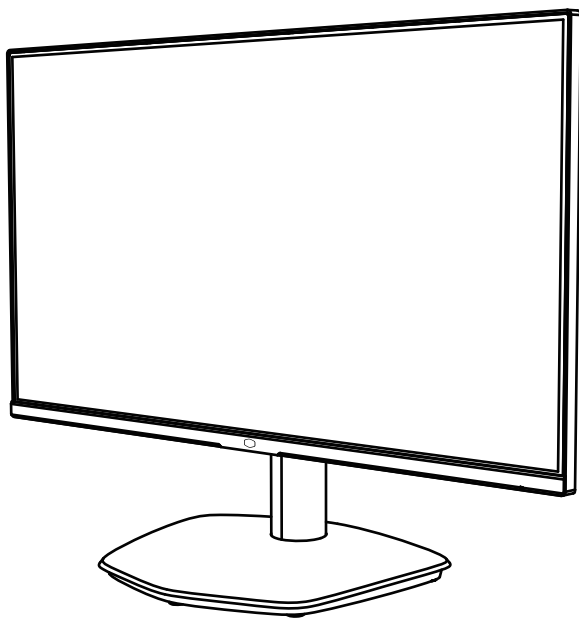

GM238-FFS

Cooler Master 23.8" Gaming Monitor

# User Manual



# Table of Contents

Requirements and Safety Notice.....	1
Important Safety Instructions.....	3
Package Contents .....	4
Installing the Monitor Stand and Base.....	5
Adjusting the Monitor.....	7
Wall Mount Installation Instructions .....	8
External Control Buttons.....	9
Main Menu.....	10
[Input Select].....	10
[Picture Setting] .....	10
[Gaming Setup].....	11
[Color Adjustment] .....	12
[Advanced Setting] .....	12
[Setup Menu] .....	14
Specifications .....	15
Supported Timing .....	16
[PC Timing].....	16
[Video Timing].....	19
Product Outline Dimensions .....	20

# Requirements and Safety Notice

## FCC Safety Notice

This product has been tested and determined to be meeting the limits for a Class B digital device and in compliance with Part 15 of the FCC Regulations. These requirements are set to reasonably protect the home installation environment from hazardous interference. This product will generate, use and emit radio frequency energy. Failure to install and use it as instructed may cause hazardous interference to radio communication. However, we cannot guarantee zero interference for certain installation methods. If this product has caused hazardous interference to radio or TV reception (turn on or turn off this product to for confirmation), the user may try to make adjustment with the following methods:

- Re-adjust the angle and position of the reception antenna.
- Increase the separation between the device and receiver.
- Do not use the power sockets of the device and receiver together.
- If assistance is needed, contact the distributor or a professional radio/TV technician.

### CE Compliance Statement

Cooler Master Technology Inc. hereby declares that the monitor conforms to the following key standards and other related provisions:

EMC Directive 2014/30/EU, Low Voltage Directive 2014/35/EU, RoHS Directive 2011/65/EU and Directive 2009/125/EC establishing a framework for the setting of eco-design requirements for energy-related products.

### Remarks:

To prevent damage of the monitor, do not lift the monitor from the support base.

### Remarks: Shielded cables

To comply with the EMC requirements, a shielded cable must be used for connection between this product and any other computer device.

### Remarks:

The monitor is exclusively used in the video and image display of information acquired from electronic devices.

### Remarks: Peripherals

Only a peripheral device (I/O device, terminal, printer, etc.) that has been certified and met the Class B limits can be sold together with this product.

If this product is used together with any other uncertified peripheral device, it may cause interference to radio and TV reception.

### Warning

Any change or modification not approved by the original manufacturer may lead to the user losing the right to operate this product. Such authorization is given by the Federal Communications Commission.

### Requirements for Use

This product meets the limits under Part 15 of the FCC Regulations. Operation is subject to the following two conditions: (1) this product may not cause harmful interference, and (2) this product must accept any signal interference received, including interference that may cause undesired operation.

The following local Manufacturer/Importer is responsible for this declaration.

<p><b>Product Name:</b> LCD Monitor <b>Model No:</b> GM238-FFS <b>Company Name:</b> North America - CMI USA, Inc. <b>Address:</b> 1 N Indian Hill Blvd Suite 200, Claremont, CA 91711, USA <b>Contact:</b> Cooler Master Representative <b>Phone:</b> +1-888-624-5099</p>
---

### Remarks: Canadian users

This Class B digital device complies with Canadian ICES-003 specifications.

Remarque à l'intention des utilisateurs canadiens

Cet appareil numérique de la classe B est conforme à la norme NMB-003 du Canada

### Disposal of Waste Equipment by Home Users in EU



If this symbol appears on a product and its package, it indicates that the product cannot be disposed of together with other household waste. You have to deliver the waste equipment to a designated recycling center for recycling of waste electrical and electronic equipment. Proper sorting and recycling of resources during the disposal of waste equipment is helpful for protecting natural resources and ensuring that resource recycling can protect human health and environment. For detailed information about recycling centers where waste equipment is disposed of, contact the local municipal office, cleaning service or the store where the purchased product is found.

# 电子电气产品有害物质限制使用标识要求

本产品有害物质的名称及含量标识如下表：

部件名称	有害物质					
	铅 (Pb)	汞 (Hg)	镉 (Cd)	六价铬 (Cr (VI))	多溴联苯 (PBB)	多溴联苯醚 (PBDE)
外壳	○	○	○	○	○	○
电路板组件*	×	○	○	○	○	○
电源线/适配器	×	○	○	○	○	○
外部信号连接线	×	○	○	○	○	○
液晶面板	×	○	○	○	○	○

本表格依据 SJ/T 11364 的规定编制。

\*：电路板组件包括印刷电路板及其构成的零部件，如电阻、电容、集成电路、连接器等

○：表示该有害物质在该部件所有均质材料中的含量均在 GB/T26572 规定的限量要求以下。

×：表示该有害物质至少在该部件的某一均质材料中的含量超出 GB/T26572 规定的限量要求。

# 限用物質含有情況標示聲明書

單元 Unit	限用物質及其化學符號 Restricted substances and its chemical symbols					
	鉛 Lead (Pb)	汞 Mercury (Hg)	鎘 Cadmium (Cd)	六價鉻 Hexavalent chromium (Cr <sup>+6</sup> )	多溴聯苯 Polybrominated biphenyls (PBB)	多溴二苯醚 Polybrominated diphenyl ethers (PBDE)
支架/外殼	○	○	○	○	○	○
印刷電路板	—	○	○	○	○	○
玻璃面板	—	○	○	○	○	○
電纜/電線/連接線	—	○	○	○	○	○
電源設備/外接電源供應器	—	○	○	○	○	○

備考1. “超出0.1 wt %” 及 “超出0.01 wt %” 係指限用物質之百分比含量超出百分比含量基準值。

備考2. “○” 係指該項限用物質之百分比含量未超出百分比含量基準值。

備考3. “—” 係指該項限用物質為排除項目。

# Important Safety Instructions

Please read the following instructions carefully.

1. To clean the LCD monitor screen:
  - Turn off the LCD monitor and unplug the power cord.
  - Spray a non-solvent cleaning solution onto a rag and clean the screen gently.
2. Do not place the LCD monitor near a window. Exposing the monitor to rain, moisture or sunlight can severely damage it.
3. Do not apply pressure to the LCD screen. Excessive pressure may cause permanent damage to the display.
4. Do not remove the cover or other things to repair the device yourself.  
An authorized technician should perform servicing of any nature
5. Store the LCD monitor in a room with a temperature of -20 °C to 60 °C (-4 °F to 140 °F).  
Storing the LCD monitor outside this range may result in permanent damage.
6. Immediately unplug your monitor and call an authorized technician if any of the following circumstances occur:
  - Monitor to PC signal cable is frayed or damaged.
  - Liquid spills onto the LCD monitor or the monitor is exposed to rain.
  - The LCD monitor or case is damaged.

# Package Contents

---

A



Monitor

B

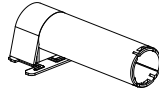

Stand

C

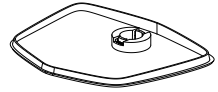

Base

---

D

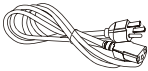

Power cord (Optional)

E



HDMI cable (Optional)

F



DP cable (Optional)

---

G

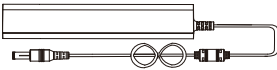

Adapter

# Installing the Monitor Stand and Base

1

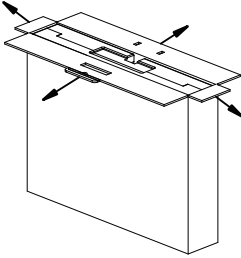

2

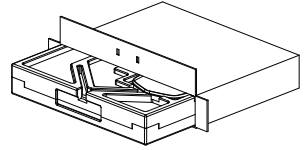

3

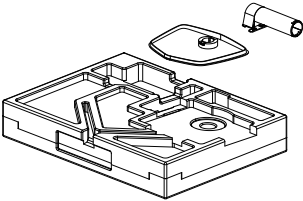

4

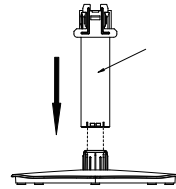

5

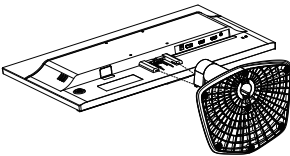

6

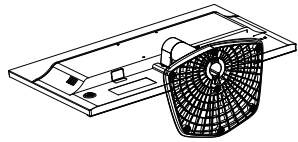

7

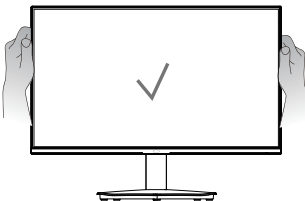

8

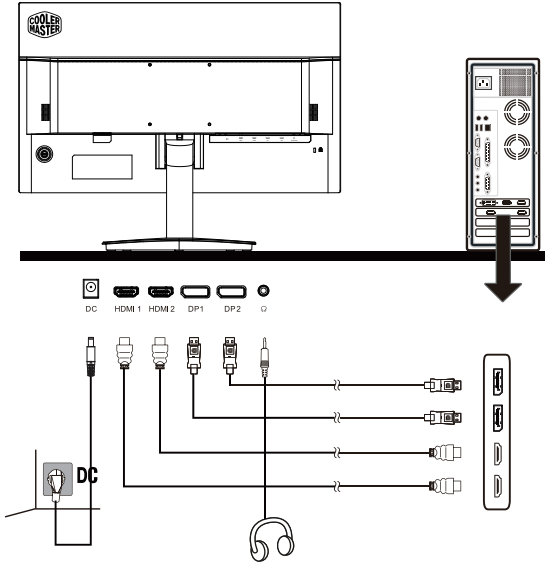

9

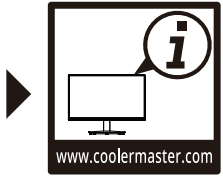
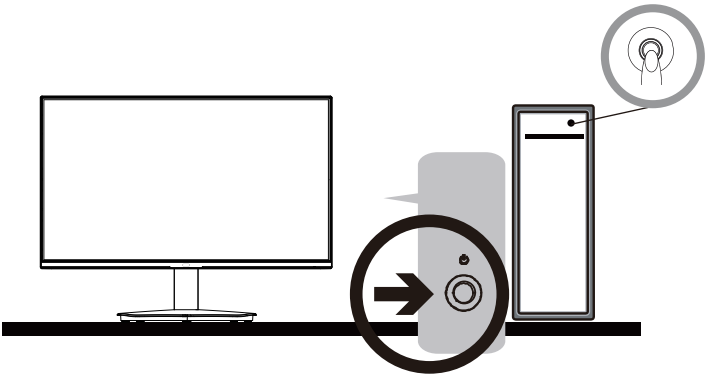



# Adjusting the Monitor

- For the best results, it is recommended to look directly at the front of the monitor and make any adjusts as necessary.
- Ensure that the monitor is mounted upright on the stand base.
- When adjusting the monitor viewing angles, avoid touching the screen and hold the stand in order to prevent it from falling over.

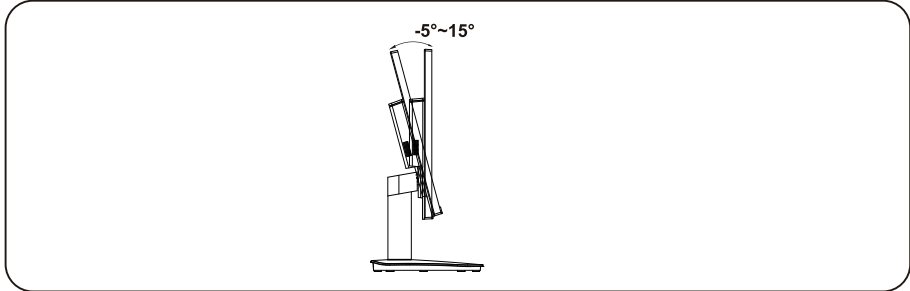

# Wall Mount Installation Instructions

1

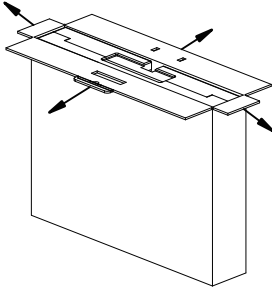

2

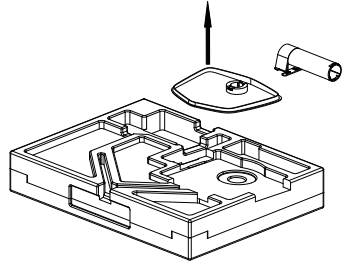

3

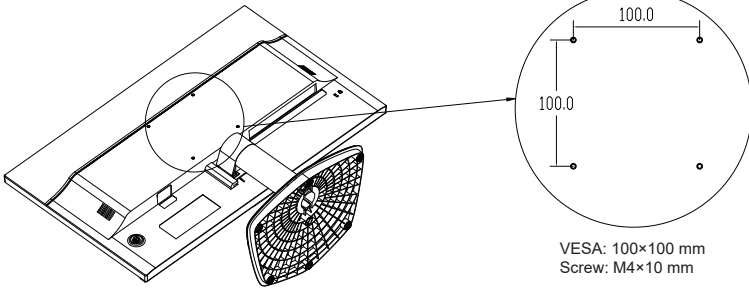

4

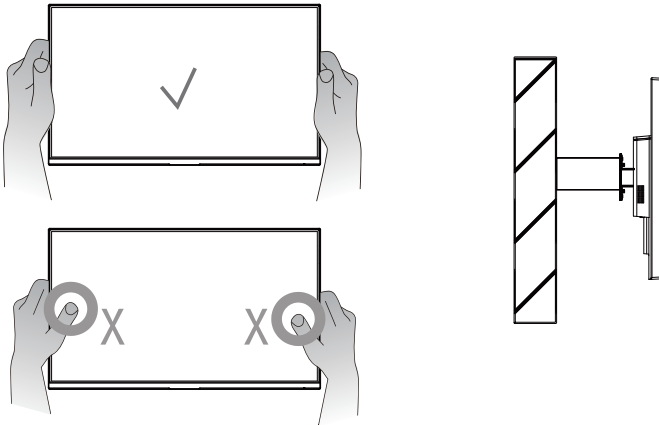

# External Control Buttons

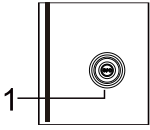

## ① Menu/Navi/OK button

Short press to turn on the monitor and Long press to turn off.

When the OSD menu is activated, pull up/down/left/right the button to adjust the settings you need.

When finished, you can pull the Button Back to return to the previous level or use the Button Exit to close the OSD menu.

Remarks: Power indicator;

Green = On;

Orange = Power saving.

The OSD Menu and OSD Quick-Menu Symbol explanations and their functional uses are stated below.

Remarks: The following content is for reference only.The actual product specifications may vary.



Confirm: Enter the sub-menu pointed by the cursor or edit the selected menu item.



Exit: Close the OSD menu.



Back: Return to the previous menu or exit edit mode.



Up: Move the cursor up.



Down: Move the cursor down.



Left: Move the cursor to the left.



Right: Move the cursor to the right.



Increase: Increase the value.



Decrease: Decrease the value.

# Main Menu

## [Input Select]

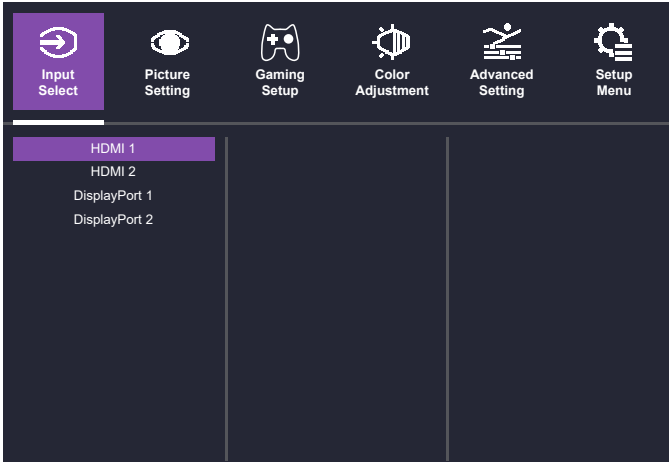

- Enter the Input Select menu to switch the input signal.
  - **HDMI 1, 2:** Maximum input signal 1920×1080@144Hz.
  - **DP 1, 2:** Maximum input signal 1920×1080@144Hz.

## [Picture Setting]

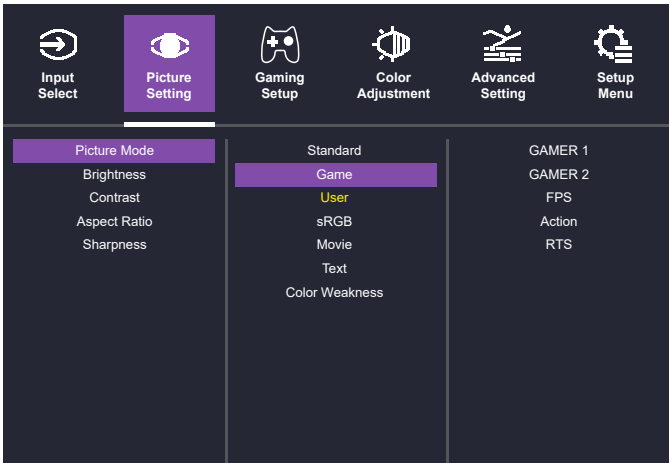

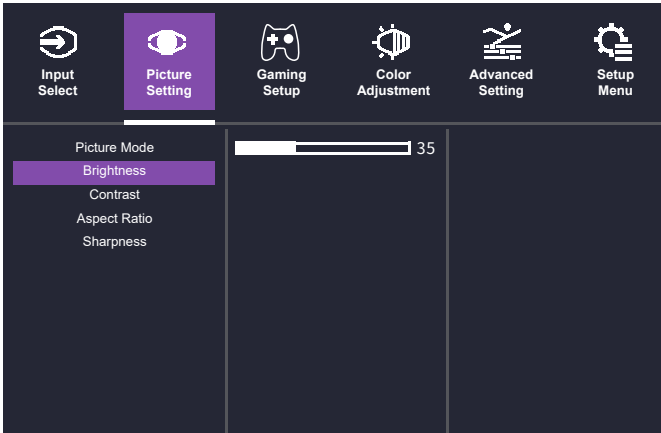

- Enter the Picture Setting menu to adjust the picture mode.
  - **Picture Mode:** Experience different picture modes.
  - **Brightness:** Adjust the backlight brightness from 0 and 100.
  - **Contrast:** Adjust the contrast from 0 and 100.
  - **Aspect Ratio:** Adjust the aspect ratio of the screen.
  - **Sharpness:** Adjust the sharpness from 0 and 100.

### [Gaming Setup]

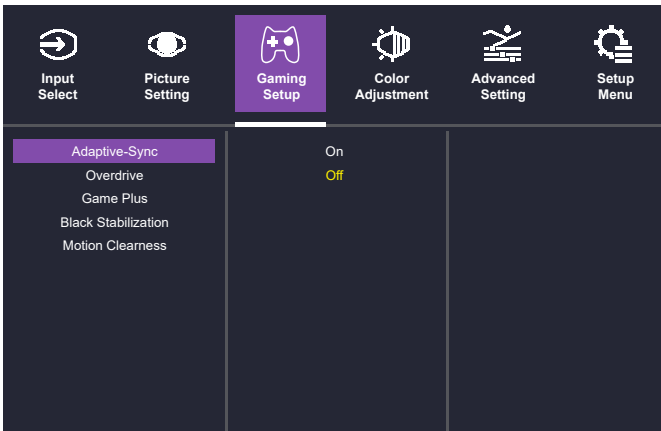

- Enter the Game Setup menu to adjust the game mode.
  - **Adaptive-Sync:** Turn it on or off.
  - **Overdrive:** Select the Off, Normal, Advanced, Ultrafast, or Dynamic mode to disable or accelerate the response time.
  - **Game Plus:** Use game assist features such as timers and frame rate prompts.
  - **Black Stabilization:** Illuminate dark areas without overexposing brighter areas. The value ranges from 0 to 100.
  - **Motion Clearness:** Turn it on when the refresh rate is greater than 75 Hz.

## [Color Adjustment]

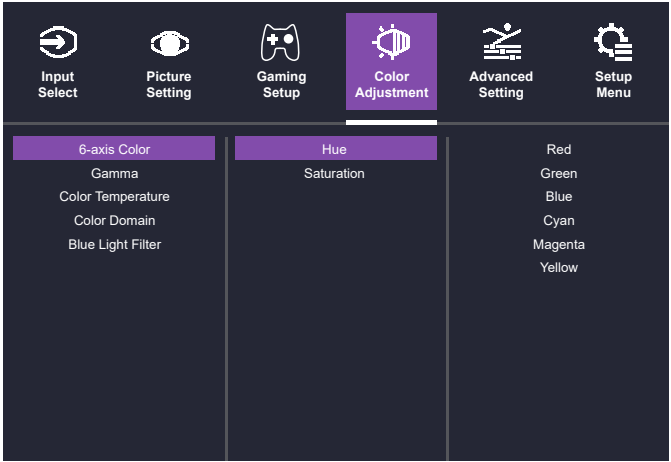

- Enter the Color Adjustment menu to adjust the color mode.
  - **6-axis Color:** Adjust the hue and saturation.
  - **Gamma:** Turn it on in User Mode under Image Mode. Set the gamma curve to 1.8, 2.0, 2.2, 2.4, or 2.6.
  - **Color Temperature:** Select Bluish, Cool, Native, Warm or User Color. Adjust the value of Red, Green, and Blue in User Mode from 0 and 100.
  - **Color Domain:** Select Auto Mode, RGB Mode, or YUV Mode.
  - **Blue Light Filter:** Protect your eyes using low blue light technology to reduce blue light emission from the monitor. The value ranges from 0 and 100.

## [Advanced Setting]

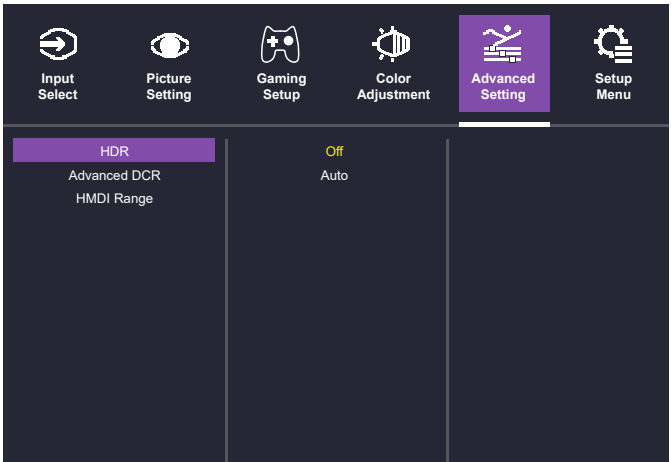

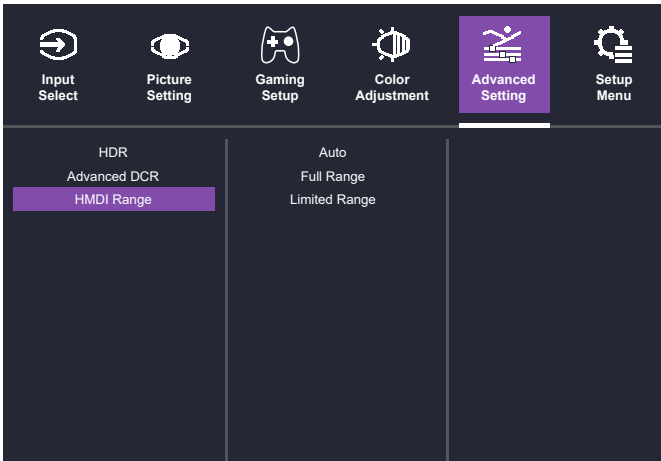
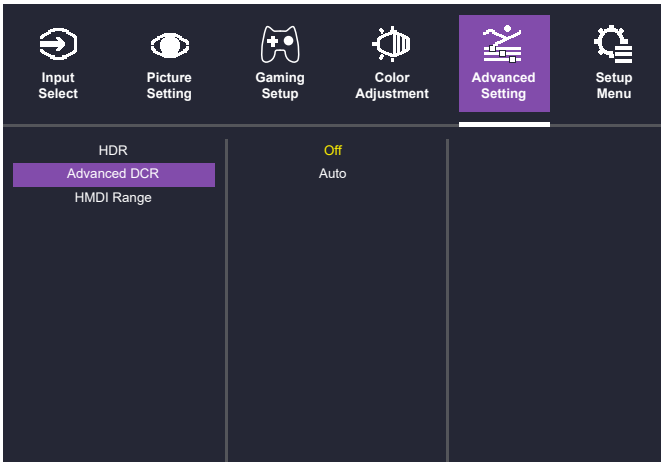

- Enter the Advanced Setting menu to select the advanced mode.
  - **HDR:** Turn it off or allow it adjust automatically.
  - **Advanced DCR:** Turn it off or allow it automatically detect the input signal brightness and backlight brightness to improve picture performance.
  - **HDMI Range:** Select Auto, Full Range, or Limited Range.



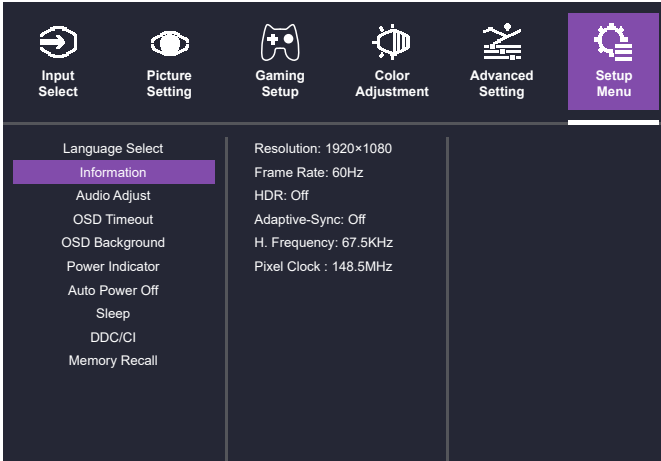
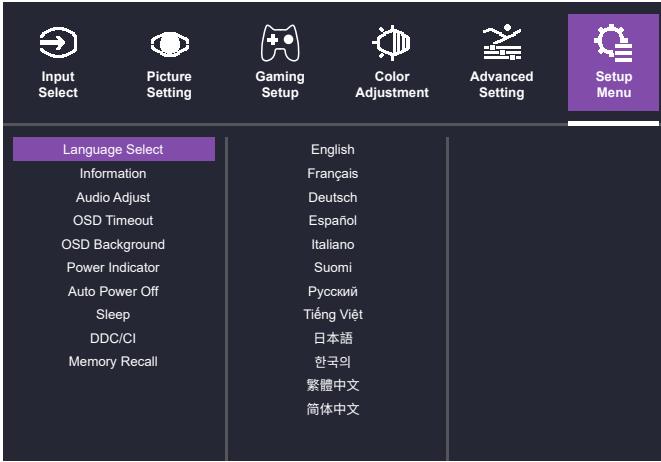





## [Setup Menu]



- Enter the Setup Menu to select your preferred settings.
  - **Language Select:** Set the language to English, French, German, Spanish, Italian, Finnish, Russian, Vietnamese, Japanese, Korean, Traditional Chinese, or Simplified Chinese.
  - **Information:** View basic information about the device such as Resolution, Frame Rate, HDR, Adaptive-Sync, H. Frequency, and Pixel Clock.
  - **Audio Adjust:** Select Mute or adjust the volume from 0 and 100.
  - **OSD Timeout:** Set the timeout to 5, 15, 30, or 60 seconds.
  - **OSD Background:** Turn it on or off.
  - **Power Indicator:** Turn it on or off.
  - **Auto Power Off:** Turn it on or off.
  - **Sleep:** Select the idle time before the monitor enters Sleep mode. The value can be 30, 45, 60, or 120 minutes.
  - **DDC/CI:** Turn it on or off.
  - **Memory Recall:** Restore the settings to default values.



# Specifications

LCD panel	Size	23.8"
	Pixel pitch	0.2745 (H) × 0.2745 (V) mm
	Brightness	250 nits (Typ.)
	Contrast	1000:1 (Typ.)
	Viewing angle	178°(Horizontal) 178°(Vertical)
	Response time	0.5 ms**
Display colors		16.7 million colors
Maximum display frequency (Resolution H * V/Fv)		1920×1080@144Hz (DP & HDMI)
Power consumption	Power On	18.3 W***
	Standby	≤ 0.5 W
	Power off	≤ 0.3 W
Input/output connector		HDMI×2 DP×2 Earphone jack×1
Input video signal		HDMI signal (HDMI models only) DP signal (DP models only)
Adapter		12 V = 4.5 A
Environmental conditions		Operating temperature: 0°C to 40°C Storage temperature: -20°C to 60°C Operating humidity: 20% to 85%
Monitor dimensions (W×D×H)		540.04×211.78×417.59 mm (with arm/base) 540.04×42×319.59 mm (without arm/base)
Box dimensions (W×D×H)		620×115×475 mm
Weight (Net)		3.05 kg/Unit (with arm/base) 2.79 kg/Unit (without arm/base)
Machine specifications		Tilt: -5°~15°
Compliance		
        		
<p>The terms HDMI, HDMI High-Definition Multimedia Interface, HDMI Trade Dress and the HDMI Logos are trademarks or registered trademarks of HDMI Licensing Administrator, Inc.</p>		

\*Specifications are subject to change without notice.

\*\*The screen may flicker and other uncomfortable phenomena when the Motion Clearness function is enabled.

\*\*\*Measure a screen brightness of 200 nits without audio/USB/Card reader connection.

If you have any question regarding use of the monitor, please visit:

<https://www.coolermaster.com/warranty>

# Supported Timing

## [PC Timing]

Mode	Resolution	H. Frequency (KHz)	Frame Rate (Hz)	Pixel Clock (MHz)	Port			
					HDMI1 Input	HDMI2 Input	DP1 Input	DP2 Input
VGA	640×480@59Hz	31.463	59.9286	25.17	○	○	○	○
	640×480@60Hz	31.5	60	25.2	○	○	○	○
	640×480@75Hz	37.5	75	31.5	○	○	○	○
	640×480@100Hz	112.5	100	297	○	○	×	×
		112.5	100	234	×	×	○	○
	640×480@119Hz	134.864	119.879	296.7	○	○	○	○
	640×480@120Hz	134.864	119.879	296.7	○	○	○	○
	640×480@144Hz	159.985	144.001	326.37	○	○	×	×
		160.13	144.002	333.07	×	×	○	○
	720×480@59Hz	31.469	59.9401	27	○	○	○	○
	720×480@60Hz	31.492	59.9845	27.02	○	○	○	○
	720×480@100Hz	112.5	100	297	○	○	×	×
		112.5	100	234	×	×	○	○
	720×480@119Hz	134.864	119.879	296.7	○	○	○	○
	720×480@120Hz	134.864	119.879	296.7	○	○	○	○
	720×480@144Hz	159.985	144.001	326.37	○	○	×	×
		160.13	144.002	333.07	×	×	○	○
	720×576@50Hz	31.25	50	27	○	○	×	×
	720×576@59Hz	67.432	59.9394	148.35	○	○	×	×
	720×576@60Hz	37.879	60.3165	40	○	○	×	×
	720×576@75Hz	46.875	75	49.5	○	○	×	×
	720×576@100Hz	112.5	100	297	○	○	×	×
	720×576@119Hz	134.864	119.879	296.7	○	○	×	×
	720×576@120Hz	134.864	119.879	296.7	○	○	×	×
720×576@144Hz	159.985	144.001	326.37	○	○	×	×	
SVGA	800×600@59Hz	67.432	59.9394	148.35	○	○	○	○
	800×600@60Hz	37.879	60.3165	40	○	○	○	○
	800×600@75Hz	46.875	75	49.5	○	○	○	○
	800×600@100Hz	112.5	100	297	○	○	×	×
		112.5	100	234	×	×	○	○
	800×600@119Hz	134.864	119.879	296.7	○	○	○	○
	800×600@120Hz	134.864	119.879	296.7	○	○	○	○
	800×600@144Hz	159.985	144.001	326.37	○	○	×	×
160.13		144.002	333.07	×	×	○	○	

Mode	Resolution	H. Frequency (KHz)	Frame Rate (Hz)	Pixel Clock (MHz)	Port			
					HDMI1 Input	HDMI2 Input	DP1 Input	DP2 Input
VESA	1152×864@59Hz	67.432	59.9394	148.35	○	○	○	○
	1152×864@60Hz	53.783	59.9586	81.75	○	○	×	×
		67.432	59.9394	148.35	×	×	○	○
	1152×864@75Hz	67.5	75	108	×	×	○	○
	1152×864@100Hz	112.5	100	297	○	○	×	×
		112.5	100	234	×	×	○	○
	1152×864@119Hz	134.864	119.879	296.7	○	○	○	○
	1152×864@120Hz	134.864	119.879	296.7	○	○	○	○
	1152×864@144Hz	159.985	144.001	326.37	○	○	×	×
		160.13	144.002	333.07	×	×	○	○
	1280×720@50Hz	37.5	50	74.25	○	○	×	×
	1280×720@59Hz	44.952	59.9354	74.17	○	○	○	○
	1280×720@60Hz	45	60	74.25	○	○	○	○
	1280×720@100Hz	112.5	100	297	○	○	×	×
		112.5	100	234	×	×	○	○
	1280×720@119Hz	134.864	119.879	296.7	○	○	○	○
1280×720@120Hz	134.864	119.879	296.7	○	○	○	○	
1280×720@144Hz	159.985	144.001	326.37	○	○	×	×	
	160.13	144.002	333.07	×	×	○	○	
XGA	1024×768@59Hz	67.432	59.9394	148.35	○	○	○	○
	1024×768@60Hz	48.363	60.0038	65	○	○	○	○
	1024×768@75Hz	60.023	75.0286	78.75	○	○	○	○
	1024×768@100Hz	112.5	100	297	○	○	×	×
		112.5	100	234	×	×	○	○
	1024×768@119Hz	134.864	119.879	296.7	○	○	○	○
	1024×768@120Hz	134.864	119.879	296.7	○	○	○	○
1024×768@144Hz	159.985	144.001	326.37	○	○	×	×	
	160.13	144.002	333.07	×	×	○	○	
SXGA	1280×1024@59Hz	67.432	59.9394	148.35	○	○	○	○
	1280×1024@60Hz	63.981	60.0197	108	○	○	○	○
	1280×1024@75Hz	79.976	75.0247	135	○	○	○	○
	1280×1024@100Hz	112.5	100	297	○	○	×	×
		112.5	100	234	×	×	○	○
	1280×1024@119Hz	134.864	119.879	296.7	○	○	○	○
	1280×1024@120Hz	134.864	119.879	296.7	○	○	○	○
	1280×1024@144Hz	159.985	144.001	326.37	○	○	×	×
		160.13	144.002	333.07	×	×	○	○
	1366×768@59Hz	67.432	59.9394	148.35	○	○	○	○
1366×768@60Hz	55.935	59.8874	106.5	○	○	○	○	

Mode	Resolution	H. Frequency (KHz)	Frame Rate (Hz)	Pixel Clock (MHz)	Port			
					HDMI1 Input	HDMI2 Input	DP1 Input	DP2 Input
SXGA	1366×768@100Hz	112.5	100	297	○	○	×	×
		112.5	100	234	×	×	○	○
	1366×768@119Hz	134.864	119.879	296.7	○	○	○	○
	1366×768@120Hz	134.864	119.879	296.7	○	○	○	○
	1366×768@144Hz	159.985	144.001	326.37	○	○	×	×
		160.13	144.002	333.07	×	×	○	○
WXGA	1280×800@59Hz	67.432	59.9394	148.35	×	×	○	○
	1280×800@60Hz	49.702	59.8103	83.5	×	×	○	○
	1280×800@100Hz	112.5	100	234	×	×	○	○
	1280×800@119Hz	134.864	119.879	296.7	×	×	○	○
	1280×800@120Hz	134.864	119.879	296.7	×	×	○	○
	1280×800@144Hz	160.13	144.002	333.07	×	×	○	○
WXGA+	1440×900@59Hz	67.432	59.9394	148.35	○	○	○	○
	1440×900@60Hz	55.935	59.8874	106.50	○	○	○	○
	1440×900@100Hz	112.5	100	297	○	○	×	×
		112.5	100	234	×	×	○	○
	1440×900@119Hz	134.864	119.879	296.7	○	○	○	○
	1440×900@120Hz	134.864	119.879	296.7	○	○	○	○
	1440×900@144Hz	159.985	144.001	326.37	○	○	×	×
		160.13	144.002	333.07	×	×	○	○
	1600×900@59Hz	67.432	59.9394	148.35	○	○	○	○
	1600×900@60Hz	60	60	108	○	○	○	○
	1600×900@100Hz	112.5	100	297	○	○	×	×
		112.5	100	234	×	×	○	○
	1600×900@119Hz	134.864	119.879	296.7	○	○	○	○
	1600×900@120Hz	134.864	119.879	296.7	○	○	○	○
	1600×900@144Hz	159.985	144.001	326.37	○	○	×	×
		160.13	144.002	333.07	×	×	○	○
WSXGA+	1680×1050@50Hz	56.25	50	148.5	○	○	×	×
	1680×1050@59Hz	67.432	59.9394	148.35	○	○	○	○
	1680×1050@60Hz	67.5	60	148.5	○	○	×	×
		65.29	59.9543	146.25	×	×	○	○
	1680×1050@100Hz	112.5	100	297	○	○	×	×
		112.5	100	234	×	×	○	○
	1680×1050@119Hz	134.864	119.879	296.7	○	○	○	○
	1680×1050@120Hz	135	120	297	○	○	×	×
		134.864	119.879	296.7	×	×	○	○
	1680×1050@144Hz	159.985	144.001	326.37	○	○	×	×
		160.13	144.002	333.07	×	×	○	○

Mode	Resolution	H. Frequency (KHz)	Frame Rate (Hz)	Pixel Clock (MHz)	Port			
					HDMI1 Input	HDMI2 Input	DP1 Input	DP2 Input
FHD	1920×1080@50Hz	56.25	50	148.5	○	○	○	○
	1920×1080@59Hz	67.432	59.9394	148.35	○	○	○	○
	1920×1080@60Hz	67.5	60	148.5	○	○	○	○
	1920×1080@100Hz	112.5	100	297	○	○	×	×
		112.5	100	234	×	×	○	○
	1920×1080@119Hz	134.864	119.879	296.7	○	○	○	○
	1920×1080@120Hz	135	120	297	○	○	×	×
		134.402	120.002	274.18	×	×	○	○
	1920×1080@144Hz	159.985	144.001	326.37	○	○	×	×
		160.13	144.002	333.07	×	×	○	○

## [Video Timing]

Video ID Code	Formats	Aspect Ratio	Field Rate (Hz)	Vertical Scanning Frequency (kHz)	Horizontal Scanning Frequency (kHz)	Pixel Clock (MHz)	H-Total	V-Total
1	640x480p	4:3	59.94	31.469	59.94	25.175	800	525
			60	31.500	60.00	25.200	800	525
2	720x480p	4:3	60	31.469	59.94	27.000	858	525
4	1280x720p	16:9	59.94	44.955	59.94	74.176	1650	750
			60	45.000	60.00	74.250	1650	750
14	1440x480p	4:3	60	31.469	60	54.000	1716	525
16	1920x1080p	16:9	59.94	67.433	59.94	148.352	2200	1125
			60	67.500	60.00	148.500	2200	1125
31	1920x1080p	16:9	50	56.250	50.00	148.500	2640	1125
63	1920x1080p	16:9	120	135	119.88/120	297	2200	1125
64	1920x1080p	16:9	100	112.5	100	297	2640	1125

# Product Outline Dimensions

