



AMD X670/B650 Series

Motherboard

Software/BIOS Setup Guide

Version 1.1

Published October 2022

Copyright©2022 ASRock INC. All rights reserved.

Version 1.1

Published October 2022

Copyright©2022 ASRock INC. All rights reserved.

Copyright Notice:

No part of this documentation may be reproduced, transcribed, transmitted, or translated in any language, in any form or by any means, except duplication of documentation by the purchaser for backup purpose, without written consent of ASRock Inc.

Products and corporate names appearing in this documentation may or may not be registered trademarks or copyrights of their respective companies, and are used only for identification or explanation and to the owners' benefit, without intent to infringe.

Disclaimer:

Specifications and information contained in this documentation are furnished for informational use only and subject to change without notice, and should not be constructed as a commitment by ASRock. ASRock assumes no responsibility for any errors or omissions that may appear in this documentation.

With respect to the contents of this documentation, ASRock does not provide warranty of any kind, either expressed or implied, including but not limited to the implied warranties or conditions of merchantability or fitness for a particular purpose.

In no event shall ASRock, its directors, officers, employees, or agents be liable for any indirect, special, incidental, or consequential damages (including damages for loss of profits, loss of business, loss of data, interruption of business and the like), even if ASRock has been advised of the possibility of such damages arising from any defect or error in the documentation or product.

Contact Information:

If you need to contact ASRock or want to know more about ASRock, you're welcome to visit ASRock's website at <http://www.asrock.com>; or you may contact your dealer for further information. For technical questions, please submit a support request form at <https://event.asrock.com/tsd.asp>

ASRock Incorporation

e-mail: info@asrock.com.tw

ASRock EUROPE B.V.

e-mail: sales@asrock.nl

ASRock America, Inc.

e-mail: sales@asrockamerica.com

Contents

| | |
|---|----------|
| Chapter 1 Introduction | 1 |
| Chapter 2 Software and Utilities Operation | 2 |
| 2.1 Auto Driver Installer (ADI) | 2 |
| 2.1.1 Installing Drivers for the First Time | 2 |
| 2.1.2 Updating Drivers | 6 |
| 2.2 ASRock Live Update & APP Shop | 7 |
| 2.2.1 Installing ASRock Live Update & APP Shop | 7 |
| 2.2.2 UI Overview | 8 |
| 2.2.3 Apps | 9 |
| 2.2.4 BIOS & Drivers | 12 |
| 2.2.5 Setting | 13 |
| 2.3 ASRock Motherboard Utility (A-Tuning) | 14 |
| 2.3.1 Installing ASRock Motherboard Utility (A-Tuning) | 14 |
| 2.3.2 Using ASRock Motherboard Utility (A-Tuning) | 14 |
| 2.4 ASRock Motherboard Utility (Phantom Gaming Tuning) | 17 |
| 2.4.1 Installing ASRock Motherboard Utility (Phantom Gaming Tuning) | 17 |
| 2.4.2 Using ASRock Motherboard Utility (Phantom Gaming Tuning) | 17 |
| 2.5 ASRock Polychrome SYNC | 20 |
| 2.5.1 Connecting the LED Strip | 20 |
| 2.5.2 Connecting the Addressable RGB LED Strip | 21 |
| 2.5.3 Installing ASRock Polychrome SYNC Utility | 22 |

| | | |
|-----|---------------|----|
| 2.6 | Nahimic Audio | 23 |
|-----|---------------|----|

Chapter 3 UEFI SETUP UTILITY 25

| | | |
|-------|---|----|
| 3.1 | Introduction | 25 |
| 3.1.1 | Entering BIOS Setup | 25 |
| 3.1.2 | UEFI Menu Bar | 26 |
| 3.1.3 | Navigation Keys | 27 |
| 3.2 | Main Screen | 28 |
| 3.3 | OC Tweaker Screen | 29 |
| 3.4 | Advanced Screen | 40 |
| 3.4.1 | CPU Configuration | 41 |
| 3.4.2 | PCI Configuration | 42 |
| 3.4.3 | Onboard Devices Configuration | 43 |
| 3.4.4 | Storage Configuration | 46 |
| 3.4.5 | ACPI Configuration | 47 |
| 3.4.6 | Trusted Computing | 49 |
| 3.4.7 | AMD CBS | 51 |
| 3.4.8 | AMD PBS | 63 |
| 3.4.9 | AMD Overclocking | 66 |
| 3.5 | Tool | 67 |
| 3.6 | Hardware Health Event Monitoring Screen | 69 |
| 3.7 | Security Screen | 75 |
| 3.8 | Boot Screen | 79 |
| 3.9 | Exit Screen | 81 |

Chapter 1 Introduction

This user guide is a complete setup guide for all AMD X670 and B650 motherboard series. The screenshots in this manual are for reference only. Settings and options may vary due to the motherboard you purchased.

In this documentation, Chapter 1 gives an overview of the setup guide. Chapter 2 contains the operation guide of the software and utilities. Chapter 3 contains the configuration guide of the BIOS setup.

Software Setup Guide

- Auto Driver Installer (ADI)
- ASRock Live Update & APP Shop
- ASRock Motherboard Utility (A-Tuning)
- ASRock Motherboard Utility (Phantom Gaming Tuning)
- ASRock Polychrome SYNC
- Nahimic Audio

BIOS Setup Guide

- UEFI Setup Utility



Because the motherboard specifications and the software might be updated, the content of this documentation will be subject to change without notice. In case any modifications of this documentation occur, the updated version will be available on ASRock's website without further notice. If you require technical support related to this motherboard, please visit our website for specific information about the model you are using. ASRock website <http://www.asrock.com>.

Chapter 2 Software and Utilities Operation

2.1 Auto Driver Installer (ADI)

Optical drive or driver DVD is no longer needed for driver installation. ASRock motherboard already has its Ethernet driver prepacked in BIOS ROM. When you finish installing the operation system, simply use the Auto Driver Installer to download and install all necessary drivers automatically.

2.1.1 Installing Drivers for the First Time

Follow the instructions to install all necessary drivers via the Auto Driver Installer. Please note that the Internet access is required during the following procedures.

Step 1

After you install the Windows OS, connect your computer to the Internet.

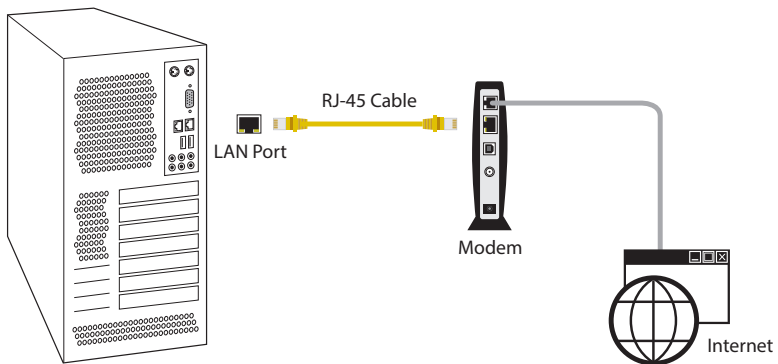

Step 2

Boot into the system, and a notification will pop up in the lower right corner of your screen saying, "Do you want to one-step-install the latest drivers simply from ASRock Auto Driver Installer?".

Select "Yes" to install Auto Driver Installer.

Select "No" to skip the installation.



1. The Auto Driver Installer will automatically pop up for users to install drivers only when the "Auto Driver Installer" item under the "Tool" menu in the BIOS is set to [Enabled]. The item is enabled by default; therefore, for the first-time users, there is no need to change the setting in the BIOS.
2. An available Internet connection is a prerequisite for using the Auto Driver Installer. If you boot into the system without Internet, the Auto Driver Installer won't appear. Now connect your computer to the Internet, wait a few seconds, and then the Auto Driver Installer will pop up.
3. If you select "No" in Step 2 and skip the installation, the Auto Driver Installer will be removed. If you would like to run the application again, please enable the "Auto Driver Installer" item in the BIOS setting.

Step 3

When it's completed, you will see the Auto Driver Installer icon on your desktop and then the Auto Driver Installer appears.



Step 4

The Auto Driver Installer panel lists all available drivers that your motherboard supports. Select one or more drivers to be installed.

Click "Select All" to select all items.

Click "Unselect All" to remove all of your selections.

Click "Update" to start downloading and installing drivers.

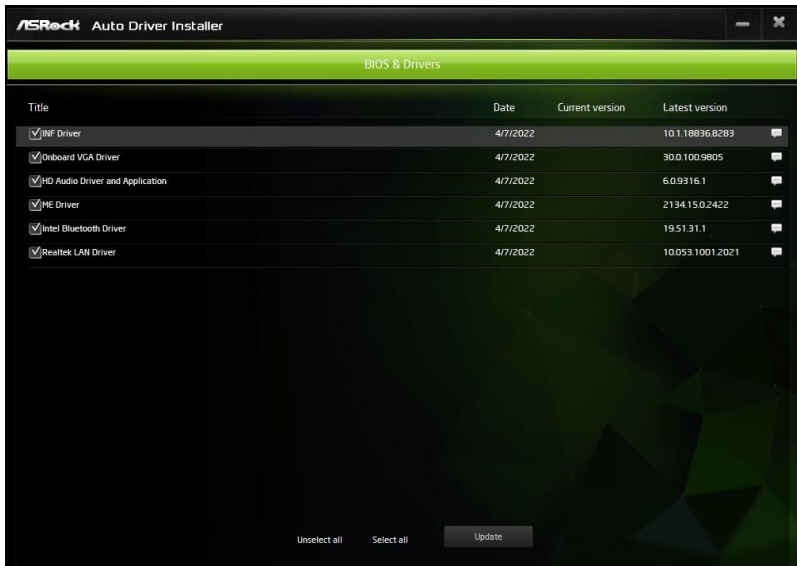

If there are no drivers to be installed, click "Finish" to exit. If you would like to run the application again, please enable the "Auto Driver Installer" item in the BIOS setting.

Step 5

A messages pops up saying, "**During installation, your system may reboot and continue installing remaining item(s)**".

Click "Yes" to continue.

Click "No" to exit.

**Step 6**

Once all drivers are successfully installed, a message pops up saying, "**Installation has been successfully completed! For further drivers and utilities, please visit ASRock's website.**"

Click "Ok" to complete the procedure.

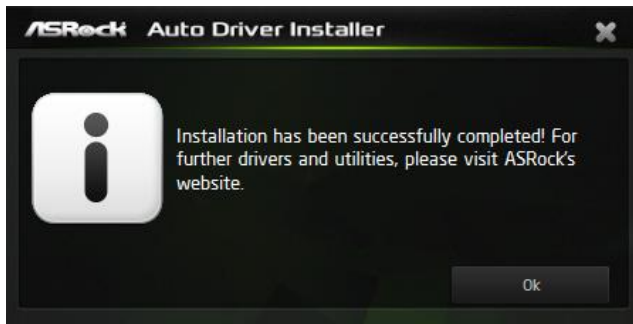

When driver installation is completed, the Auto Driver Installer tool will be uninstalled automatically from your computer.



After driver installation, the Auto Driver Installer will be removed. If you would like to run the application again, please go to the "Tool" menu in the BIOS setting, and set the "Auto Driver Installer" item to [Enabled].

2.1.2 Updating Drivers

Updating drivers ensures that your system work well without any issue. To update drivers, please go to ASRock' website (<https://www.asrock.com>) and select "Support" > "Latest Drivers Update".

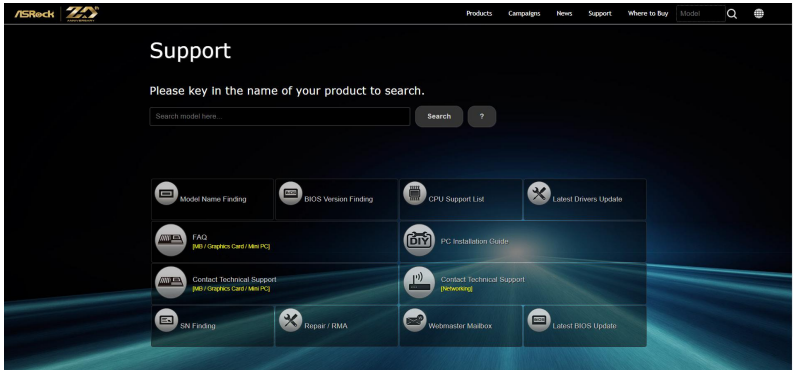

2.2 ASRock Live Update & APP Shop

The ASRock Live Update & APP Shop is an online store for purchasing and downloading software applications for your ASRock computer. You can quickly and easily install various apps and support utilities. With ASRock Live Update & APP Shop, you can optimize your system and keep your motherboard up to date simply with a few clicks.

2.2.1 Installing ASRock Live Update & APP Shop

Please download the ASRock Live Update & APP Shop utility from the ASRock's website: "<https://www.asrock.com>".

Go to the product page of your motherboard, select "Support" > "Download" to download the APP Shop.

The screenshot shows the ASRock website's support page. The 'Support' tab is selected, and the 'Download' section is active. A dropdown menu shows 'Windows 11 64bit'. Below is a table of available software utilities.

| Description | OS | Size | Date | Download |
|---|-------------------|---------|------------|--------------------|
| Realtek high definition audio driver ver:92311_UAD_WHQL_Nahmic | Windows® 11 64bit | 35.5MB | 2021/10/12 | 🇬🇧 Global 🇨🇳 China |
| AMD chipset driver ver:3.10.22.706 | Windows® 11 64bit | 50.33MB | 2021/11/30 | 🇬🇧 Global 🇨🇳 China |
| Killer Lan driver ver:3.0.1606 | Windows® 11 64bit | 38.8MB | 2021/10/8 | 🇬🇧 Global 🇨🇳 China |
| AMD RAIDxpert2 utility ver:9.2.0.158 | Windows® 11 64bit | 95.4MB | 2021/5/31 | 🇬🇧 Global 🇨🇳 China |
| SATA Floppy Image_CC ver:9.3.0.296 | Windows® 11 64bit | 361KB | 2022/2/8 | 🇬🇧 Global 🇨🇳 China |
| SATA Floppy Image_DID ver:9.3.0.296 | Windows® 11 64bit | 361KB | 2022/2/8 | 🇬🇧 Global 🇨🇳 China |
| NVMe_DID Supported AMD processors: <small>(Renoir) - AMD Ryzen™ 3000 Series Desktop Processors with Radeon™ Graphics (Cezanne) - AMD Ryzen™ 4000 Series Desktop Processors with Radeon™ Graphics</small> | Windows® 11 64bit | 361KB | 2022/2/8 | 🇬🇧 Global 🇨🇳 China |
| VGA driver ver:21.30.02.210727a_0827 | Windows® 11 64bit | 587MB | 2021/10/8 | 🇬🇧 Global 🇨🇳 China |
| ASRock Motherboard Utility ver:3.0.466 | Windows® 11 64bit | 59.40MB | 2022/5/17 | 🇬🇧 Global 🇨🇳 China |
| APP Shop ver:1.0.02 | Windows® 11 64bit | 3.91MB | 2021/5/31 | 🇬🇧 Global 🇨🇳 China |
| Nahmic3 utility ver:210913_APO4 | Windows® 11 64bit | 85.3MB | 2021/11/8 | 🇬🇧 Global 🇨🇳 China |
| Norton Security ver:22.21.5 | Windows® 11 64bit | 232MB | 2021/10/8 | 🇬🇧 Global 🇨🇳 China |
| Restart to UEFI ver:1.0.9 | Windows® 11 64bit | 1.01MB | 2021/11/8 | 🇬🇧 Global 🇨🇳 China |
| Beta ASRock Motherboard Utility ver:3.0.441 | Windows® 11 64bit | 59.31MB | 2021/12/14 | 🇬🇧 Global 🇨🇳 China |

After installation, double-click  on your desktop to access ASRock Live Update & APP Shop utility.

**You need to be connected to the Internet to download apps from the ASRock Live Update & APP Shop.*

2.2.2 UI Overview

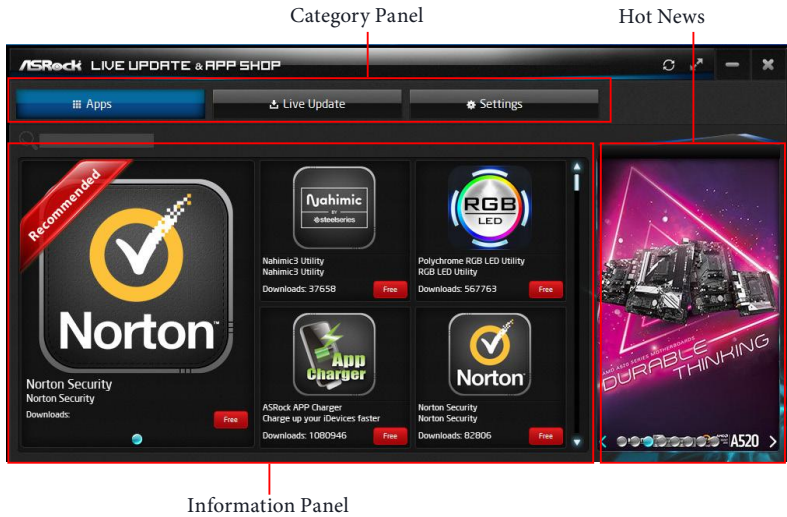

Category Panel: The category panel contains several category tabs or buttons that when selected the information panel below displays the relative information.

Information Panel: The information panel in the center displays data about the currently selected category and allows users to perform job-related tasks.

Hot News: The hot news section displays the various latest news. Click on the image to visit the website of the selected news and know more.

2.2.3 Apps

When the "Apps" tab is selected, you will see all the available apps on screen for you to download.

Installing an App

Step 1

Find the app you want to install.

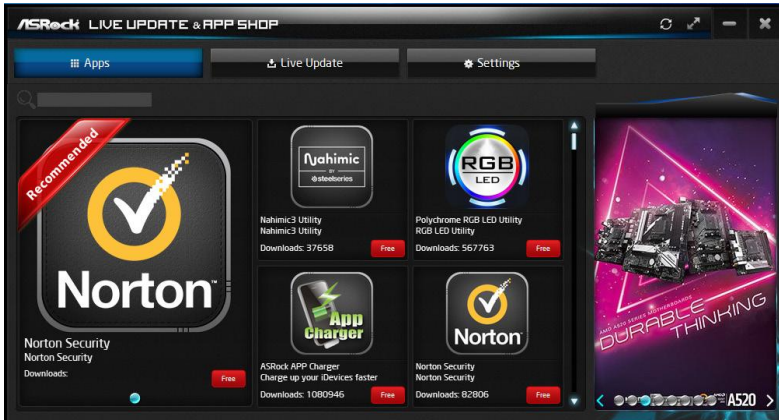

The most recommended app appears on the left side of the screen. The other various apps are shown on the right. Please scroll up and down to see more apps listed.

You can check the price of the app and whether you have already installed it or not.



- The red icon displays the price or "Free" if the app is free of charge.



- The green "Installed" icon means the app is installed on your computer.

Step 2

Click on the app icon to see more details about the selected app.

Step 3

If you want to install the app, click on the red icon **Free** to start downloading.



Step 4

When installation completes, you can find the green "Installed" icon appears on the upper right corner.

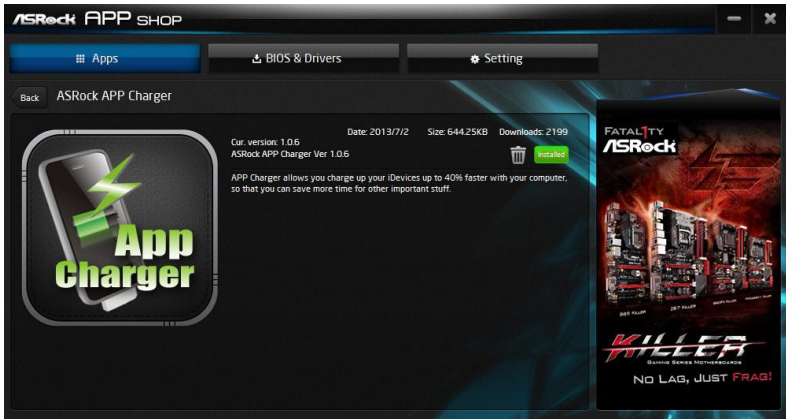

To uninstall it, simply click on the trash can icon .
*The trash icon may not appear for certain apps.

Upgrading an App

You can only upgrade the apps you have already installed. When there is an available new version for your app, you will find the mark of "New Version" appears below the installed app icon.



Step 1

Click on the app icon to see more details.

Step 2

Click on the yellow icon  to start upgrading.

2.2.4 BIOS & Drivers

Installing BIOS or Drivers

When the "BIOS & Drivers" tab is selected, you will see a list of recommended or critical updates for the BIOS or drivers. Please update them all soon.



Step 1

Please check the item information before update. Click on ⓘ to see more details.

Step 2

Click to select one or more items you want to update.

Step 3

Click Update to start the update process.

2.2.5 Setting

In the "Setting" page, you can change the language, select the server location, and determine if you want to automatically run the ASRock Live Update & APP Shop on Windows startup.

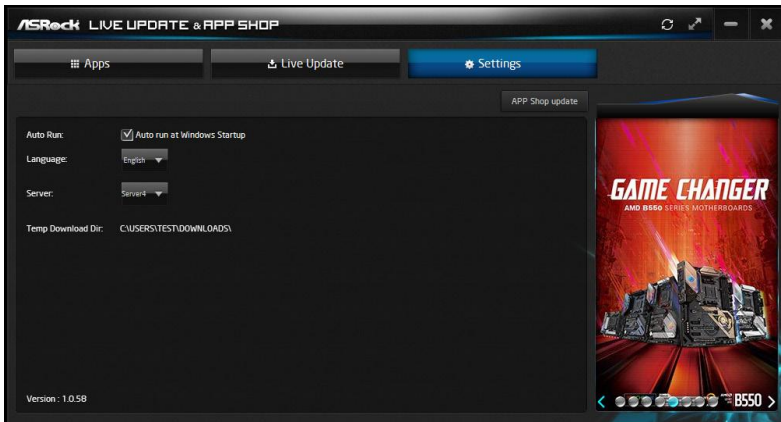

2.3 ASRock Motherboard Utility (A-Tuning)

ASRock Motherboard Utility (A-Tuning) is ASRock's multi purpose software suite with a new interface, more new features and improved utilities.

2.3.1 Installing ASRock Motherboard Utility (A-Tuning)

ASRock Motherboard Utility (A-Tuning) can be downloaded from ASRock Live Update & APP Shop.

You can also download the utility from the ASRock's website: "<https://www.asrock.com>". Go to the product page of your motherboard, select "Support" > "Download" to download "ASRock Motherboard Utility".

After the installation, you will find the icon "ASRock Motherboard Utility (A-Tuning)" on your desktop. Double-click the "ASRock Motherboard Utility (A-Tuning)" icon , ASRock Motherboard Utility (A-Tuning) main menu will pop up.

2.3.2 Using ASRock Motherboard Utility (A-Tuning)

There are five sections in ASRock Motherboard Utility (A-Tuning) main menu: Operation Mode, OC Tweaker, System Info, FAN-Tastic Tuning and Settings.

Operation Mode

Choose an operation mode for your computer.

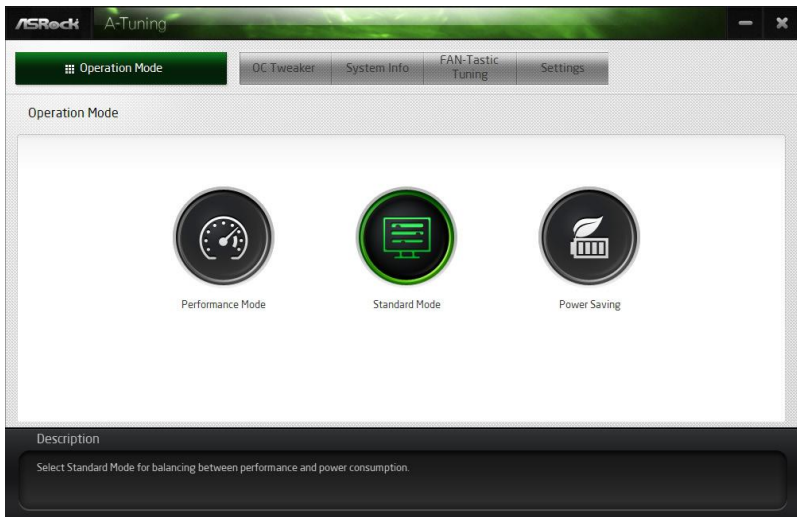

OC Tweaker

Configurations for overclocking the system.

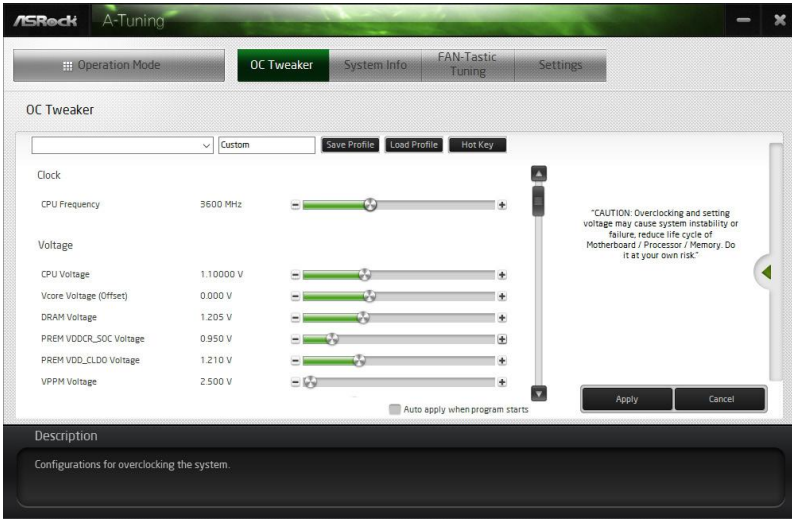

System Info

View information about the system.

*The System Browser tab may not appear for certain models.

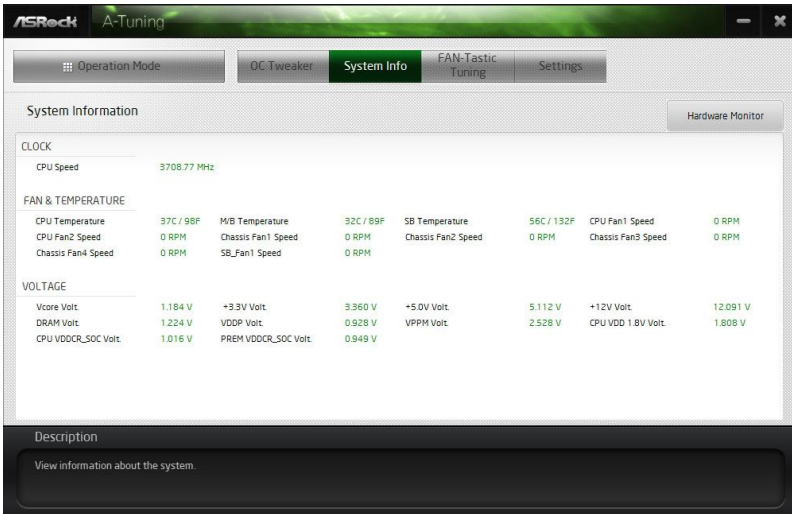

FAN-Tastic Tuning

Configure up to five different fan speeds using the graph. The fans will automatically shift to the next speed level when the assigned temperature is met.

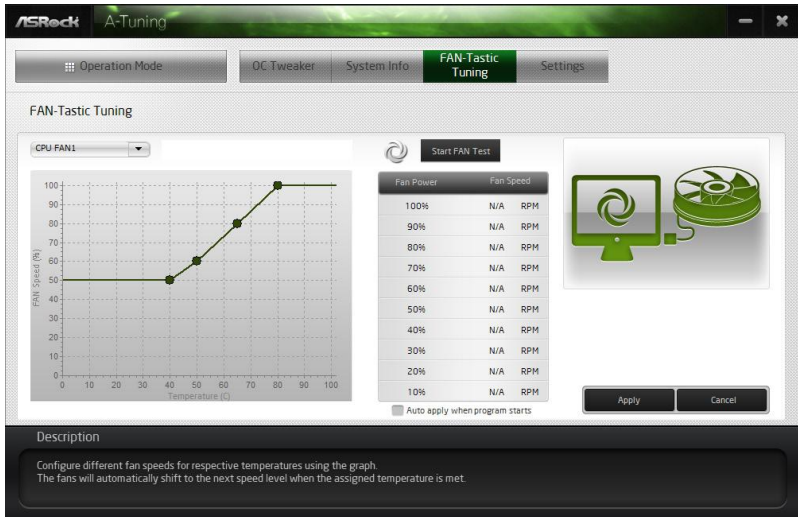

The screenshot shows the ASRock A-Tuning software interface. The 'FAN-Tastic Tuning' tab is active. On the left, a graph plots 'FAN Speed (%)' on the y-axis (0 to 100) against 'Temperature (°C)' on the x-axis (0 to 100). A green line with circular markers shows a step-wise increase in fan speed as temperature rises. To the right of the graph is a 'Start FAN Test' button and a table with columns for 'Fan Power' and 'Fan Speed'. Below the table is a 'Start FAN Test' button and an 'Apply' button. A 'Description' box at the bottom explains the graph's function.

| Fan Power | Fan Speed |
|-----------|-----------|
| 100% | N/A RPM |
| 90% | N/A RPM |
| 80% | N/A RPM |
| 70% | N/A RPM |
| 60% | N/A RPM |
| 50% | N/A RPM |
| 40% | N/A RPM |
| 30% | N/A RPM |
| 20% | N/A RPM |
| 10% | N/A RPM |

Auto apply when program starts

Apply **Cancel**

Description
Configure different fan speeds for respective temperatures using the graph.
The fans will automatically shift to the next speed level when the assigned temperature is met.

Settings

Configure ASRock ASRock Motherboard Utility (A-Tuning). Click to select "Auto run at Windows Startup" if you want ASRock Motherboard Utility (A-Tuning) to be launched when you start up the Windows operating system.

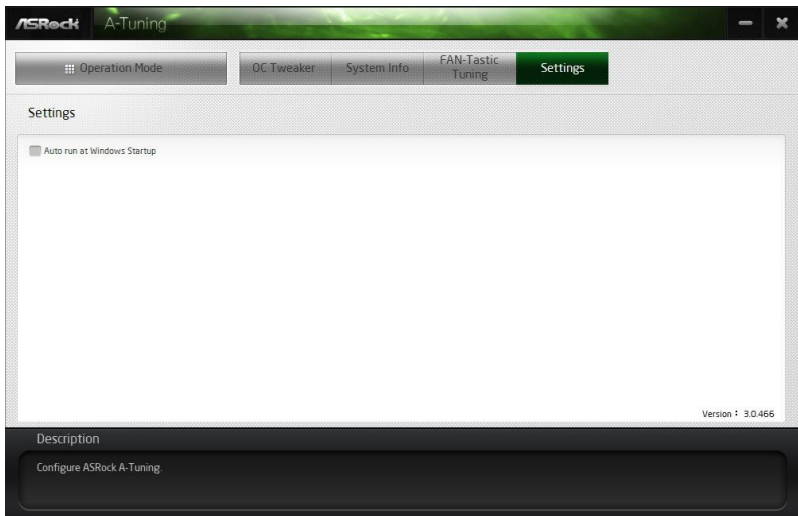

The screenshot shows the ASRock A-Tuning software interface with the 'Settings' tab active. A single checkbox labeled 'Auto run at Windows Startup' is visible and is currently unchecked. At the bottom right, the version number 'Version 1.3.0.466' is displayed. A 'Description' box at the bottom explains the window's purpose.

Auto run at Windows Startup

Version 1.3.0.466

Description
Configure ASRock A-Tuning.

2.4 ASRock Motherboard Utility (Phantom Gaming Tuning)

ASRock Motherboard Utility (Phantom Gaming Tuning) is ASRock's multi purpose software suite with a new interface, more new features and improved utilities.

2.4.1 Installing ASRock Motherboard Utility (Phantom Gaming Tuning)

ASRock Motherboard Utility (Phantom Gaming Tuning) can be downloaded from ASRock Live Update & APP Shop.

You can also download the utility from the ASRock's website: "<https://www.asrock.com>". Go to the product page of your motherboard, select "Support" > "Download" to download "ASRock Motherboard Utility".

After the installation, you will find the icon "Phantom Gaming Tuning" on your desktop. Double-click the "Phantom Gaming Tuning"  icon, Phantom Gaming Tuning main menu will pop up.

2.4.2 Using ASRock Motherboard Utility (Phantom Gaming Tuning)

There are five sections in ASRock Motherboard Utility (Phantom Gaming Tuning) main menu: Operation Mode, OC Tweaker, System Info, FAN-Tastic Tuning and Settings.

Operation Mode

Choose an operation mode for your computer.

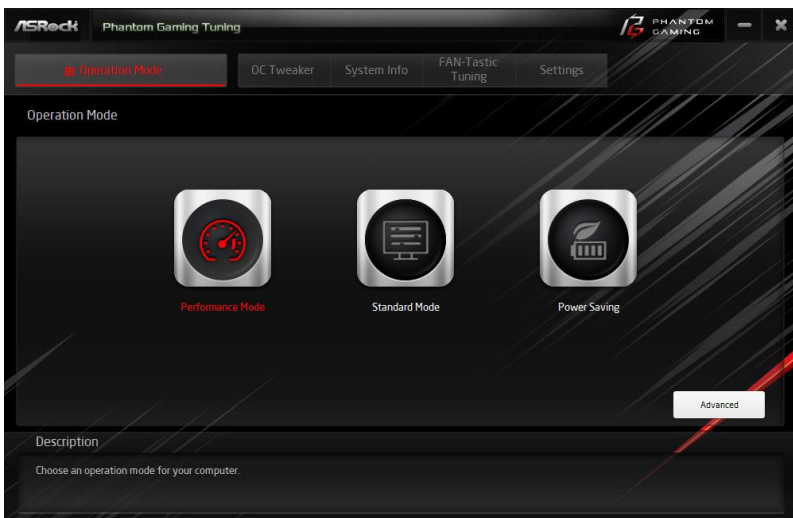

OC Tweaker

Configurations for overlocking the system.



System Info

View information about the system.

*The System Browser tab may not appear for certain models.

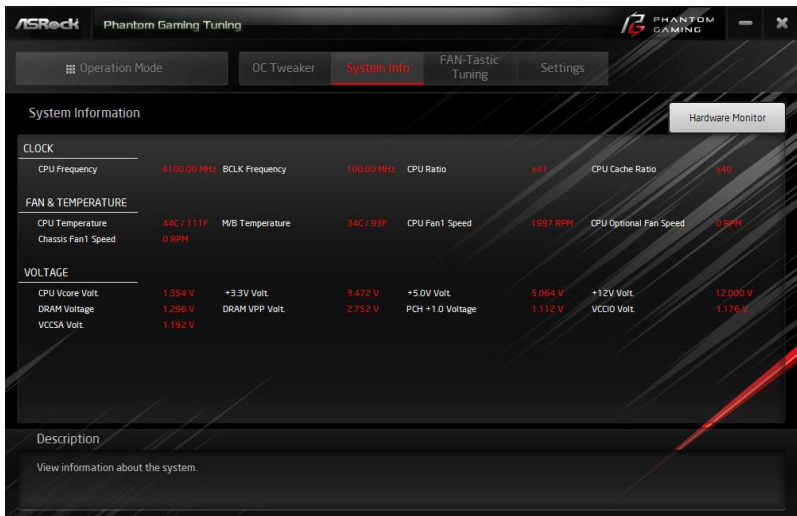

FAN-Tastic Tuning

Configure up to five different fan speeds using the graph. The fans will automatically shift to the next speed level when the assigned temperature is met.

The screenshot displays the 'FAN-Tastic Tuning' window in ASRock Phantom Gaming Tuning. The interface includes a menu bar with 'Operation Mode', 'OC Tweaker', 'System Info', 'FAN-Tastic Tuning', and 'Settings'. The main area features a graph titled 'FAN-Tastic Tuning' with a dropdown for 'CHASSIS FAN1' and radio buttons for 'Cpu Temp.' and 'M/B Temp.'. The graph plots 'FAN Speed (%)' on the y-axis (0-100) against 'Temperature (C)' on the x-axis (0-100). A red line shows a step-like increase in fan speed as temperature rises. To the right, a 'Start FAN Test' button is present, along with a table of fan settings and an 'Auto apply when program starts' checkbox. A 'Description' box at the bottom explains the graph's function.

| Fan Power | Fan Speed |
|-----------|-----------|
| 100% | N/A RPM |
| 90% | N/A RPM |
| 80% | N/A RPM |
| 70% | N/A RPM |
| 60% | N/A RPM |
| 50% | N/A RPM |
| 40% | N/A RPM |
| 30% | N/A RPM |
| 20% | N/A RPM |
| 10% | N/A RPM |

Auto apply when program starts

Description
Configure different fan speeds for respective temperatures using the graph. The fans will automatically shift to the next speed level when the assigned temperature is met.

Settings

Configure ASRock Phantom Gaming Tuning. Click to select "Auto run at Windows Startup" if you want Phantom Gaming Tuning to be launched when you start up the Windows operating system.

The screenshot shows the 'Settings' window in ASRock Phantom Gaming Tuning. The 'Settings' tab is selected in the menu bar. The main area contains a single checkbox labeled 'Auto run at Windows Startup', which is checked. At the bottom, a 'Description' box states 'Configure ASRock Phantom Gaming'. The version number 'Version: 3.0.230' is visible in the bottom right corner.

Auto run at Windows Startup

Description
Configure ASRock Phantom Gaming

Version: 3.0.230

2.5 ASRock Polychrome SYNC

ASRock Polychrome SYNC is a lighting control utility specifically designed for unique individuals with sophisticated tastes to build their own stylish colorful lighting system. Simply by connecting the LED strip, you can customize various lighting schemes and patterns, including Static, Breathing, Strobe, Cycling, Music, Wave and more.

2.5.1 Connecting the LED Strip

Connect your RGB LED strip to the **RGB LED Header** on the motherboard.

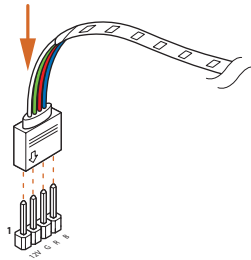

RGB LED Header



1. Never install the RGB LED cable in the wrong orientation; otherwise, the cable may be damaged.
2. Before installing or removing your RGB LED cable, please power off your system and unplug the power cord from the power supply. Failure to do so may cause damages to motherboard components.



1. Please note that the RGB LED strips do not come with the package.
2. The RGB LED header supports standard 5050 RGB LED strip (12V/G/R/B), with a maximum power rating of 3A (12V) and length within 2 meters.

2.5.2 Connecting the Addressable RGB LED Strip

Connect your Addressable RGB LED strip to the **Addressable LED Header** on the motherboard.

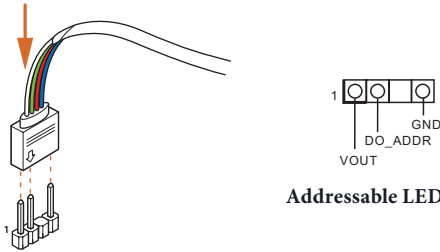

Addressable LED Header



1. Never install the RGB LED cable in the wrong orientation; otherwise, the cable may be damaged.
2. Before installing or removing your RGB LED cable, please power off your system and unplug the power cord from the power supply. Failure to do so may cause damages to motherboard components.



1. Please note that the RGB LED strips do not come with the package.
2. The RGB LED header supports WS2812B addressable RGB LED strip (5V/Data/GND), with a maximum power rating of 3A (5V) and length within 2 meters.

2.5.3 Installing ASRock Polychrome SYNC Utility

After connecting the required LED strips, download the ASRock Polychrome SYNC Utility from the ASRock Live Update & APP Shop. You can also download the utility from the ASRock's website: "<https://www.asrock.com>". Go to the product page of your motherboard, select "Support" > "Download" to download the ASRock Polychrome RGB.

Now you can adjust the RGB LED color through this utility and start coloring your PC style your way!

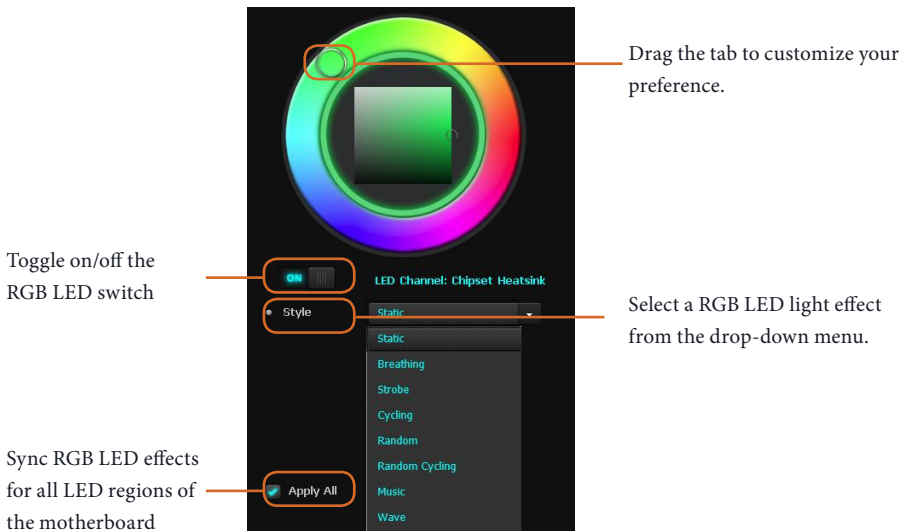

2.6 Nahimic Audio

Nahimic audio software provides an incredible high definition sound technology which boosts the audio and voice performance of your system. Nahimic Audio interface is composed of four tabs: Audio, Microphone, Sound Tracker and Settings.

Download this utility from the ASRock Live Update & APP Shop. You can also download the utility from the ASRock's website: "<https://www.asrock.com>". Go to the product page of your motherboard, select "Support" > "Download" to download the Nahimic utility.

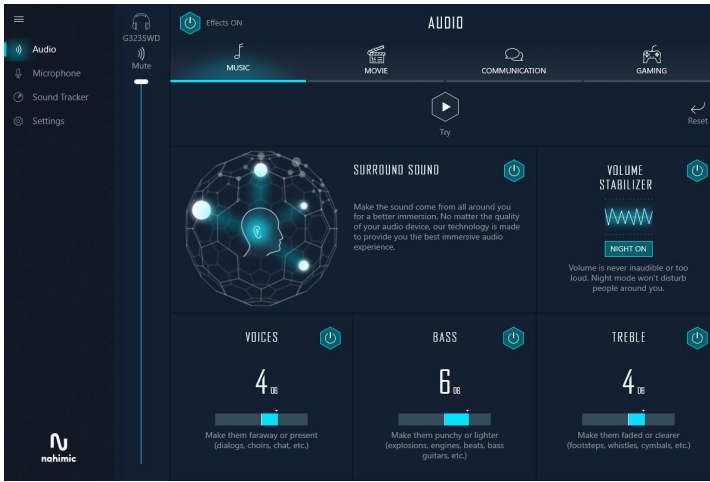

There are four functions in Nahimic audio:

| No. | Function | Description |
|-----|---------------|--|
| 1 | Audio | From this tab, you can mute the current audio device, choose between four factory audio profiles, turn all audio effects on/off, restores the current profile to its default settings and access Surround Sound and various features. |
| 2 | Microphone | From this tab, you can mute the current mic device, choose between two factory mic profiles, turn/off all microphone effects, restore the current profile to its default settings, and access Static Noise Suppression and various features. |
| 3 | Sound Tracker | The Sound Tracker provides a visual indication localizing the sources of the sounds while in a game. These are represented by dynamic segments pointing the direction of the sounds: the more opaque they are, the stronger the sounds are. |

-
- 4** Settings From this tab, you can access all settings and information of the software.

Chapter 3 UEFI SETUP UTILITY

3.1 Introduction

ASRock UEFI (Unified Extensible Firmware Interface) is a BIOS utility which offers tweak-friendly options in an advanced viewing interface. The UEFI system works with a USB mouse and offers users a faster, sleeker experience.

This BIOS utility can perform the Power-On Self-Test (POST) during system startup, record hardware parameters of the system, load operating system, and so on. The battery on the motherboard supplies the power needed to the CMOS when the system power is turned off, and the values configured in the UEFI utility are kept in the CMOS.

Please note that inadequate BIOS settings may cause system instability, malfunction or boot failure. We strongly recommend that you do not alter the UEFI default configurations or change the settings only with the assistance of a trained service person.

If the system becomes unstable or fails to boot after you change the setting, try to clear the CMOS values and reset the board to default values. See your motherboard manual for instructions.

3.1.1 Entering BIOS Setup

You may run the UEFI SETUP UTILITY by pressing <F2> or right after you power on the computer; otherwise, the Power-On-Self-Test (POST) will continue with its test routines. If you wish to enter the UEFI SETUP UTILITY after POST, restart the system by pressing <Ctl> + <Alt> + <Delete>, or by pressing the reset button on the system chassis. You may also restart by turning the system off and then back on.

This setup guide explains how to use the UEFI SETUP UTILITY to configure all the supported system. The screenshots in this manual are for reference only. UEFI Settings and options may vary owing to different BIOS release versions or CPU installed. Please refer to the actual BIOS version of the motherboard you purchased for detailed screens, settings and options.

3.1.2 UEFI Menu Bar

The top of the screen has a menu bar with the following selections:

| | |
|--------------------|---|
| Main | For setting system time/date information |
| OC Tweaker | For overclocking configurations |
| Advanced | For advanced system configurations |
| Tool | Useful tools |
| H/W Monitor | Displays current hardware status |
| Security | For security settings |
| Boot | For configuring boot settings and boot priority |
| Exit | Exit the current screen or the UEFI Setup Utility |



Because the UEFI software is constantly being updated, the following UEFI setup screens and descriptions for reference purpose only, and may vary from the latest BIOS and do not exactly match what you see on your screen.



Please realize that there is a certain risk involved with overclocking, including adjusting the setting in the BIOS, applying Untied Overclocking Technology, or using third-party overclocking tools. Overclocking may affect your system's stability, or even cause damage to the components and devices of your system. It should be done at your own risk and expense. We are not responsible for possible damage caused by overclocking.

3.1.3 Navigation Keys

Use <←> key or <→> key to choose among the selections on the menu bar, and use <↑> key or <↓> key to move the cursor up or down to select items, then press <Enter> to get into the sub screen. You can also use the mouse to click your required item.

Please check the following table for the descriptions of each navigation key.

| Navigation Key(s) | Description |
|-------------------|--|
| + / - | To change option for the selected items |
| <Tab> | Switch to next function |
| <PGUP> | Go to the previous page |
| <PGDN> | Go to the next page |
| <HOME> | Go to the top of the screen |
| <END> | Go to the bottom of the screen |
| <F1> | To display the General Help Screen |
| <F7> | Discard changes and exit the SETUP UTILITY |
| <F9> | Load optimal default values for all the settings |
| <F10> | Save changes and exit the SETUP UTILITY |
| <F12> | Print screen |
| <ESC> | Jump to the Exit Screen or exit the current screen |

3.2 Main Screen

When you enter the UEFI SETUP UTILITY, the Main screen will appear and display the system overview.

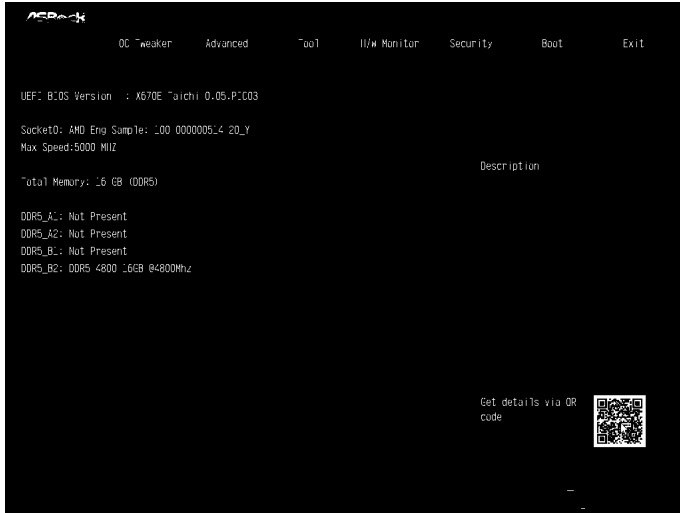

Because the UEFI software is constantly being updated, the following UEFI setup screens and descriptions are for reference purpose only, and they may not exactly match what you see on your screen. Options may also vary depending on the features of your motherboard.

3.3 OC Tweaker Screen

In the OC Tweaker screen, you can set up overclocking features.



BCLK Configuration

Press [Enter] to configure BCLK options.

BCLK Frequency

The CPU speed is determined by the CPU Ratio multiplied with the BCLK. Increasing the BCLK will increase the internal CPU clock speed but also affect the clock speed of other components.

BCLK SSC Mode

Allows you to select the BCLK Spread Spectrum Mode.

Configuration options: [Auto] [Disabled] [Down Spreading 0.10%] [Down Spreading 0.25%] [Down Spreading 0.50%] [Center Spreading 0.10%] [Center Spreading 0.25%] [Center Spreading 0.50%]

BCLK Frequency F0D1

The CPU speed is determined by the CPU Ratio multiplied with the BCLK. Increasing the BCLK will increase the internal CPU clock speed but also affect the clock speed of other components.

F0D1 SSD Mode

Allows you to select the BCLK Spread Spectrum Mode.

Configuration options: [Auto] [Disabled] [Down Spreading 0.10%] [Down Spreading 0.25%] [Down Spreading 0.50%] [Center Spreading 0.10%] [Center Spreading 0.25%] [Center Spreading 0.50%]

Spectrum Spreading Share

When two SSC engines have the same modulation frequency, setting this bit to 1 will align the phase of F0D1 SSC to F0D0 SSC.

Configuration options: [Auto] [Disabled] [Enabled]

CPU Overclocking

Allows you to configure CPU overclocking settings.

[Auto] Select this item to apply the default BCLK Delay setting.

[Customize] Select this item to customize BCLK Delay setting.

DRAM Frequency

If [Auto] is selected, the motherboard will detect the memory module(s) inserted and assign the appropriate frequency automatically.

DRAM Profile

Loads XMP settings to overclock the DDR5 memory and perform beyond standard specifications.

DRAM Timing Configuration

Allows you to configure DRAM Timing.

CAS# Latency (tCL)

The time between sending a column address to the memory and the beginning of the data in response.

RAS# to CAS# Delay to Read (tRCDRD)

The number of clock cycles required between the opening of a row of memory and accessing columns within it.

Row Precharge Time (tRP)

The number of clock cycles required between the issuing of the precharge command and opening the next row.

RAS# Active Time (tRAS)

The number of clock cycles required between a bank active command and issuing the precharge command.

RAS# Cycle Time (tRC)

The number of memory clock cycles from activate command to another activate command.

Write Recovery Time (tWR)

The amount of delay that must elapse after the completion of a valid write operation, before an active bank can be precharged.

Refresh Cycle Time (tRFC1)

Specifies the Refresh Recovery Delay Time.

Refresh Cycle Time (tRFC2)

Specifies the Refresh Recovery Delay Time.

Refresh Cycle Time (tRFCsb)

Specifies the Refresh Recovery Delay Time.

Read to Precharge (tRTP)

The number of clocks that are inserted between a read command to a row pre-charge command to the same rank.

RAS to RAS Delay (tRRD_L)

The number of clocks between two rows activated in different banks of the same rank.

RAS to RAS Delay (tRRD_S)

The number of clocks between two rows activated in different banks of the same rank.

Four Activate Window (tFAW)

Specifies the time window in which four activates are allowed the same rank.

Write to Read Delay (tWTR_L)

The number of clocks between the last valid write operation and the next read command to the same internal bank.

Write to Read Delay (tWTR_L)

The number of clocks between the last valid write operation and the next read command to the same internal bank.

TrdrdScL

The minimum number of cycles from the last clock of virtual CAS of the first read-burst operation to the clock in which CAS is asserted for a following read-burst operation in the same chipselect in the same bank group.

TrdrdSc

The minimum number of cycles from the last clock of virtual CAS of the first read-burst operation to the clock in which CAS is asserted for a following read-burst operation in the same chipselect.

TrdrdSd

The minimum number of cycles from the last clock of virtual CAS of the first read-burst operation to the clock in which CAS is asserted for a following read-burst operation in the same DIMM.

TrdrdDd

The minimum number of cycles from the last clock of virtual CAS of the first read-burst operation to the clock in which CAS is asserted for a following read-burst operation in a different DIMM.

TwrrwrScL

The minimum number of cycles from the last clock of virtual CAS of a first write-burst operation to the clock in which CAS is asserted for a following write-burst operation in the same bank group.

TwrrwrSc

The minimum number of cycles from the last clock of virtual CAS of the first write-burst operation to the clock in which CAS is asserted for a following write-burst operation in the same chipselect.

TwrrwrSd

The minimum number of cycles from the last clock of virtual CAS of the first write-burst operation to the clock in which CAS is asserted for a following write-burst operation in the same DIMM.

TwrrwrDd

The minimum number of cycles from the last clock of virtual CAS of the first write-burst operation to the clock in which CAS is asserted for a following write-burst operation in a different DIMM.

Twrrd

The minimum number of cycles from the last clock of virtual CAS of the first write-burst operation to the clock in which CAS is asserted for a following read-burst operation.

Trdwr

The minimum number of cycles from the last clock of virtual CAS of the first read-burst operation to the clock in which CAS is asserted for a following write-burst operation.

DRAM Bus Control Configuration

Press [Enter] to configure DRAM Bus Control options.

Power Down Enable

Allows you to enable or disable DDR5 power down mode.

Configuration options: [Auto] [Disabled] [Enabled]

Dram ODT impedance RTT_NOM_RD

Allows you to specify the Dram ODT impedance RTT_NOM_RD.

Configuration options: [Auto] [RTT_OFF] [RZQ (240)] [RZQ/2 (120)] [RZQ/3 (80)] [RZQ/6 (60)] [RZQ/5 (48)] [RZQ/6 (40)] [RZQ/7 (34)]

Dram ODT impedance RTT_NOM_WR

Allows you to specify the Dram ODT impedance RTT_NOM_WR.

Configuration options: [Auto] [RTT_OFF] [RZQ (240)] [RZQ/2 (120)] [RZQ/3 (80)] [RZQ/6 (60)] [RZQ/5 (48)] [RZQ/6 (40)] [RZQ/7 (34)]

Dram ODT impedance RTT_WR

Allows you to specify the Dram ODT impedance RTT_WR.

Configuration options: [Auto] [RTT_OFF] [RZQ (240)] [RZQ/2 (120)] [RZQ/3 (80)] [RZQ/6 (60)] [RZQ/5 (48)] [RZQ/6 (40)] [RZQ/7 (34)]

Dram ODT impedance RTT_PARK

Allows you to specify the Dram ODT impedance RTT_PARK.

Configuration options: [Auto] [RTT_OFF] [RZQ (240)] [RZQ/2 (120)] [RZQ/3 (80)] [RZQ/6 (60)] [RZQ/5 (48)] [RZQ/6 (40)] [RZQ/7 (34)]

Dram ODT impedance DQS_RTT_PARK

Allows you to specify the Dram ODT impedance DQS_RTT_PARK.

Configuration options: [Auto] [RTT_OFF] [RZQ (240)] [RZQ/2 (120)] [RZQ/3 (80)]

[RZQ/6 (60)] [RZQ/5 (48)] [RZQ/6 (40)] [RZQ/7 (34)]

Dram DQ drive strengths

Allows you to select the Dram Pull-up and Pull-Down Driver Impedance for all DQ and DMI IOs.

[Auto] Select this item to apply the default setting.

Processor ODT impedance

Allows you to specify the Processor ODT impedance.

[Auto] Select this item to apply the default setting.

Processor DQ drive strengths

Allows you to specify the Processor DQ drive strengths.

[Auto] Select this item to apply the default setting.

Processor CA drive strengths

Allows you to specify the Processor CA drive strengths.

[Auto] Select this item to apply the default setting.

Infinity Fabric Frequency and Dividers

AMD Overclocking Setup Set Infinity Fabric frequency (FCLK).

[Auto] FCLK = MCLK.

[Manual] FCLK must be less than or equal to MCLK for the best performance in most cases. Latency penalties are incurred if FCLK and MCLK are mismatched, but sufficiently high MCLK can negate or overcome this penalty.

UCLK DIV1 MODE

Allows you to set UCLK DIV mode.

VDDG CCD Voltage

VDDG CCD represents voltage for the data portion of the Infinity Fabric. It is derived from the CPU SoC/Uncore Voltage (VDD_SOC). VDDG can approach but not exceed VDD_SOC.

VDDG IOD Voltage

VDDG IOD represents voltage for the data portion of the Infinity Fabric. It is derived from the CPU SoC/Uncore Voltage (VDD_SOC). VDDG can approach but not exceed VDD_SOC.

VDDP Voltage

VDDP is a voltage for the DDR bus signaling (PHY), and it is derived from your DRAM Voltage (VDDIO_Mem). As a result, VDDP voltage can approach but not exceed your DRAM Voltage.

SoC/Uncore OC Voltage(VID)

Allows you to specify the SoC/Uncore voltage (VDD_SOC) to support memory and Infinity Fabric overclocking. VDD_SOC also determines the GPU voltage on processors with integrated graphics.

VDD Misc Voltage

Allows you to configure the PCIe, DP Phy, PLL, ClkGen, and Pmux Supply.

DRAM VDDIO Voltage

Use this item to configure the VDDIO Voltage.

Seperate DRAM VDDIO Voltage Control

Allows you to configure the Seperate DRAM VDDIO Voltage control setting.

DRAM VPP Voltage

Allows you to configure the VPP Voltage supportewd by PMIC at DRAM side.

[Auto] Select this item to apply the default setting.

External Voltage Settings

Press [Enter] to configure the voltage options.

VDDCR_CPU Voltage

Input voltage for the processor by the external voltage regulator.

[Auto]

Select this item to apply the default VDDCR_CPU voltage setting.

[Offset Mode]

This mode allows you to configure the VDDCR_CPU voltage offset value.

[Fixed Mode]

This mode allows you to set a fixed VDDCR_CPU voltage value.

VDDCR_CPU Load-Line Calibration

Load-Line is defined by Intel VRM Spec and affects the CPU power voltage. CPU Load-Line Calibration helps prevent CPU voltage droop when the system is under heavy loading.

Higher load-line (Level 1 or Disable) calibration gets higher voltage and good overclocking performance but increases the CPU and VRM thermal.

Configuration options: [Auto] [Level1]-[Level5]

VDDCR_CPU Auto Phase

Allows you to configure VDDCR_CPU Auto Phase.

[Enabled] Select this item to enable VDDCR_CPU Auto Phase support.

[Disabled] Select this item to disable VDDCR_CPU Auto Phase support.

VDDCR_CPU Over Voltage Protection

Allows you to configure VDDCR_CPU Over Voltage Protection.

[Enabled] Select this item to enable VDDCR_CPU Over Voltage Protection.

[Disabled] Select this item to disable VDDCR_CPU Over Voltage Protection.

VDDCR_CPU Over Current Protection

Allows you to configure VDDCR_CPU Over Current Protection.

[Enabled] Select this item to enable VDDCR_CPU Over Current Protection support.

[Disabled] Select this item to disable VDDCR_CPU Over Current Protection support.

VDDCR_CPU VR_HOT

Allows you to configure VDDCR_CPU VR_HOT.

VDDCR_CPU OTP Mode

[Enabled] Select this item to enable VDDCR_CPU OTP Mode.

[Disabled] Select this item to disable VDDCR_CPU OTP Mode.

VDDCR_CPU OTP Temperature

Allows you to configure VDDCR_CPU OTP Temperature.

VDDCR_SOC Voltage

Input voltage for the processor by the external voltage regulator.

[Auto]

Select this item to apply the default VDDCR_SOC voltage setting.

[Offset Mode]

This mode allows you to configure the VDDCR_SOC voltage offset value.

[Fixed Mode]

This mode allows you to set a fixed VDDCR_SOC voltage value.

VDDCR_SOC Load-Line Calibration

VDDCR_SOC Load-Line Calibration helps prevent CPU voltage droop when the system is under heavy load.

Configuration options: [Auto] [Level1]-[Level5]

VDDCR_SOC Auto Phase

Allows you to configure VDDCR_SOC Auto Phase.

[Enabled] Select this item to enable VDDCR_SOC Auto Phase support.

[Disabled] Select this item to disable VDDCR_SOC Auto Phase support.

VDDCR_SOC VR_HOT

Allows you to configure VDDCR_SOC VR_HOT.

VDDCR_SOC OTP Mode

[Enabled] Select this item to enable VDDCR_SOC OTP Mode.

[Disabled] Select this item to disable VDDCR_SOC OTP Mode.

VDDCR_SOC OTP Temperature

Allows you to configure VDDCR_SOC OTP Temperature.

VDD_MISC Voltage

Input voltage for the processor by the external voltage regulator.

[Auto]

Select this item to apply the default VDDCR_MISC voltage setting.

[Offset Mode]

This mode allows you to configure the VDDCR_MISC voltage offset value.

[Fixed Mode]

This mode allows you to set a fixed VDDCR_MISC voltage value.

VDD_MISC Load-Line Calibration

VDD_MISC Load-Line Calibration helps prevent CPU voltage droop when the system is under heavy load.

Configuration options: [Auto] [Level 1]-[Level 5]

VDD_MISC Auto Phase

Allows you to configure VDD_MISC Auto Phase.

[Enabled] Select this item to enable VDD_MISC Auto Phase support.

[Disabled] Select this item to disable VDD_MISC Auto Phase support.

VDD_MISC Over Voltage Protection

Allows you to configure VDD_MISC Over Voltage Protection.

[Enabled] Select this item to enable VDD_MISC Over Voltage Protection.

[Disabled] Select this item to disable VDD_MISC Over Voltage Protection.

VDD_MISC Over Current Protection

Allows you to configure VDD_MISC Over Current Protection.

[Enabled] Select this item to enable VDD_MISC Over Current Protection.

[Disabled] Select this item to disable VDD_MISC Over Current Protection.

VDD_MISC VR_HOT

Allows you to configure VDD_MISC VR_HOT.

VDD_MISC OTP Mode

[Enabled] Select this item to enable VDD_MISC OTP Mode.

[Disabled] Select this item to disable VDD_MISC OTP Mode.

VDD_MISC OTP Temperature

Allows you to configure VDD_MISC OTP Temperature.

VDD_MISC Voltage

Allows you to configure the voltage for the VDD_MISC Voltage.

[Auto]

Select this item to apply the default VDD_MISC voltage setting.

[Offset Mode]

This mode allows you to configure the VDD_MISC voltage offset value.

[Fixed Mode]

This mode allows you to set a fixed VDD_MISC voltage value.

1.8VSB Voltage

Allows you to configure the voltage for the 1.8VSB Voltage.

[Auto] Select this item to apply the default setting.

+1.05V_RUN Voltage

Allows you to configure the voltage for the +1.05V_RUN Voltage.

[Auto] Select this item to apply the default setting.

+1.05V_ALW Voltage

Allows you to configure the voltage for the +1.05V_ALW Voltage.

[Auto] Select this item to apply the default setting.

Save User Default

Type a profile name and press enter to save your settings as user default.

Load User Default

Loads previously saved user defaults.

Save User UEFI Setup Profile to Disk

Saves current UEFI settings as an user default profile to disk.

Load User UEFI Setup Profile to Disk

Loads previously saved user defaults from the disk.

3.4 Advanced Screen

In this section, you may set the configurations for the following items: CPU Configuration, PCI Configuration, Onboard Devices Configuration, Storage Configuration, ACPI Configuration, Trusted Computing, AMD CBS, AMD PBS and AMD Overclocking.



Setting wrong values in this section may cause the system to malfunction.

Active Page on Entry

Allows you to select the default page when entering the UEFI setup utility.

Configuration options: [Main] [OC Tweaker] [Advanced] [Tool] [H/W Monitor] [Security] [Boot] [Exit]

Full HD UEFI BIOS

[Auto]

When [Auto] is selected, the resolution will be set to 1920 x 1080 if the monitor supports Full HD resolution. If the monitor does not support Full HD resolution, then the resolution will be set to 1024 x 768.

[Disabled]

When [Disabled] is selected, the resolution will be set to 1024 x 768 directly.

3.4.1 CPU Configuration

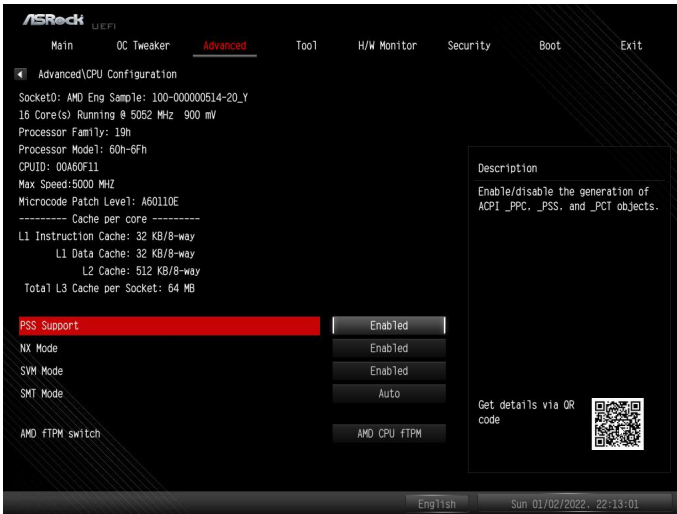

PSS Support

Allows you to enable or disable the generation of ACPI_PPC, _PSS, and _PCT objects.

NX Mode

Allows you to enable or disable No-execute page protection function.

SVM Mode

When this is set to [Enabled], a VMM (Virtual Machine Architecture) can utilize the additional hardware capabilities provided by AMD-V. The default value is [Enabled]. Configuration options: [Enabled] and [Disabled].

SMT Mode

This item can be used to disable symmetric multithreading. To re-enable SMT, a power cycle is needed after selecting [Auto].

Warning: S3 is not supported on systems where SMT is disabled.

AMD fTPM Switch

Use this to enable or disable AMD CPU fTPM.

Configuration options: [AMD CPU fTPM] [Route to SPI TPM] [Disabled]

3.4.2 PCI Configuration



Above 4G Decoding

Globally enables or disables 64-bit capable devices to be decoded in Above 4G Address Space (only if the system supports 64-bit PCI Decoding).

Re-Size BAR Support

If system has Resizable BAR capable PCIe Devices, this option enables or disables Resizable BAR Support.

Above 4GB MMIO Limit

Allows you to select Above 4GB MMIO Limit to 38~43 bits limit. This option works only when "Above 4G decoding" is enabled.

Configuration options: [40bit (1TB)] [41bit (2TB)] [42bit (4TB)] [43bit (8TB)]

SR-IOV Support

If system has SR-IOV capable PCIe Devices, this option enables or disables Single Root IO Virtualization Support.

3.4.3 Onboard Devices Configuration

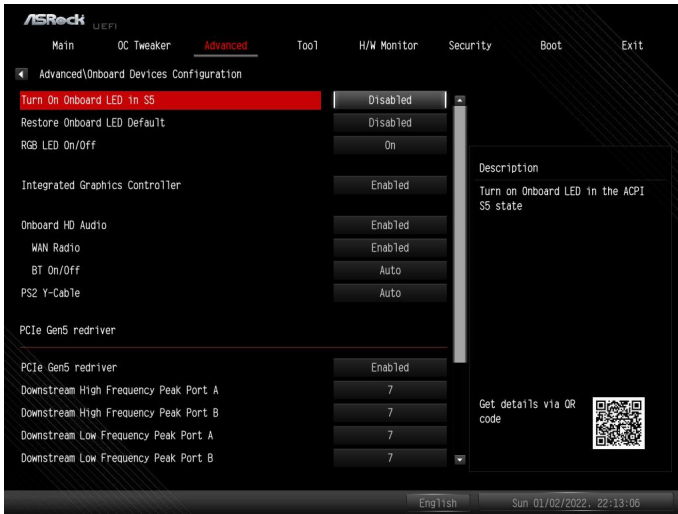

Turn On Onboard LED in S5

Allows you to turn on/off the LED in the ACPI S5 state.

[Disabled] Select this item to turn off the LED in the ACPI S5 state.

[Enabled] Select this item to turn on the LED in the ACPI S5 state.

Restore Onboard LED Default

Allows you to restore Onboard LED default value.

[Disabled] Select this item to not to restore Onboard LED default value.

[Apply] Select this item to restore Onboard LED default value.

RGB LED On/Off

Allows you to enable or disable the RGB LED.

[On] Select this item to enable the RGB LED.

[Off] Select this item to disable the RGB LED.

Integrated Graphics Controller

Allows you to enable or disable integrated graphics controller. When it is set to [Customize], the UMA Frame buffer Size option below appears and is allowed to be

configured.

Configuration options: [Disabled] [Enabled] [Customize]

UMA Frame buffer Size

Disable CSM to get frame buffer size more than 2GB. Configure the size of memory that is allocated to the integrated graphics processor when the system boots up.

[Auto] BIOS will configure this setting automatically.

Onboard HD Audio

Allows you to enable or disable onboard HD audio.

WAN Radio

Allows you to configure the WiFi module's connectivity.

BT On/Off

Allows you to enable or disable the bluetooth.

Configuration options: [Auto] [Disabled] [Enabled]

PS2 Y-Cable

Enable the PS2 Y-Cable or set this option to Auto.

PCIe Gen5 redriver

Allows you to enable or disable the PCIe Gen5 redriver.

Downstream High Frequency Peak Port A

Allows you to configure the Downstream High Frequency Peak Port A settings.

Downstream High Frequency Peak Port B

Allows you to configure the Downstream High Frequency Peak Port B settings.

Downstream Low Frequency Peak Port A

Allows you to configure the Downstream Low Frequency Peak Port A settings.

Downstream Low Frequency Peak Port B

Allows you to configure the Downstream Low Frequency Peak Port B settings.

Upstream High Frequency Peak Port A

Allows you to configure the Upstream High Frequency Peak Port A settings.

Upstream High Frequency Peak Port B

Allows you to configure the Upstream High Frequency Peak Port B settings.

Upstream Low Frequency Peak Port A

Allows you to configure the Upstream Low Frequency Peak Port A settings.

Upstream Low Frequency Peak Port B

Allows you to configure the Upstream Low Frequency Peak Port B settings.

Driver Swing

Allows you to configure the Driver Swing settings.

Configuration options: [Auto] [600 mVppd] [640 mVppd] [670 mVppd] [700 mVppd]

Flat Gain

Allows you to configure the Flat Gain settings.

Configuration options: [Auto] [-2.5 dB] [-1.5 dB] [-0.5 dB] [0.5 dB]

3.4.4 Storage Configuration



SATA Mode

This item allows you to select the SATA type.

[AHCI] Select this item to support new features that improve performance.

[RAID] Select this item to combine multiple disk drives into a logical unit.

NVMe Configuration

The item only appears when there is a NVMe M.2 device installed on the motherboard.

Press [Enter] to view NVMe controller and Drive information.

3.4.5 ACPI Configuration



Suspend to RAM

It is recommended to select auto for ACPI S3 power saving.

Configuration options: [Disabled] [Auto]

Restore on AC/Power Loss

Allows you to select the power state after a power failure.

[Power Off] Select this item and the power will remain off when the power recovers.

[Power On] Select this item and the system will start to boot up when the power recovers.

Configuration options: [Power On] [Power Off]

Deep Sleep

Allows you to configure deep sleep mode for power saving when the computer is shut down. We recommend disabling Deep Sleep for better system compatibility and stability.

Configuration options: [Disabled] [Enabled in S5] [Enabled in S4 & S5]

PS/2 Keyboard S4/S5 Wakeup Support

The item allows the system to be waked up by a PS/2 Keyboard in S4/S5.

PCIE Devices Power On

[Enabled] Select this item to allow the system to be waked up by a PCIE device and enable wake on LAN.

[Disabled] Select this item to disallow the system to be waked up by a PCIE device and disable wake on LAN.

RTC Alarm Power On

[Enabled]

Select this item to allow the system to be waked up by the real time clock alarm.

[Disabled]

Select this item to disallow the system to be waked up by the real time clock alarm.

[By OS]

Select this item to let it be handled by your operating system.

3.4.6 Trusted Computing



NOTE: Options vary depending on the version of your connected TPM module.

Security Device Support

Allows you to enable or disable BIOS support for security device. O.S. will not show Security Device. TCG EFI protocol and INT1A interface will not be available.

Active PCR banks

This item displays active PCR Banks.

Available PCR Banks

This item displays available PCR Banks.

SHA256 PCR Bank

Allows you to enable or disable SHA256 PCR Bank.

SHA384 PCR Bank

Allows you to enable or disable SHA384 PCR Bank.

Pending Operation

Allows you to schedule an Operation for the Security Device.

NOTE: Your computer will reboot during restart in order to change State of the Device.

Configuration options: [None] [TPM Clear]

Platform Hierarchy

Allows you to enable or disable Platform Hierarchy.

Storage Hierarchy

Allows you to enable or disable Storage Hierarchy.

Endorsement Hierarchy

Allows you to enable or disable Endorsement Hierarchy.

Physical Presence Spec version

Allows you to select this item to tell OS to support PPI spec version 1.2 or 1.3. Please note that some HCK tests might not support version 1.3.

Configuration options: [1.2] [1.3]

Device Select

Use this item to select the TPM device to be supported.

[TPM 1.2] Select this item to restrict support to TPM 1.2 devices.

[TPM 2.0] Select this item to restrict support to TPM 2.0 devices.

[Auto] Select this item to support both TPM 1.2 and 2.0 devices, with the default set to TPM 2.0 devices. If TPM 2.0 devices are not found, TPM 1.2 devices will be enumerated.

3.4.7 AMD CBS



CPU Common Options

Press [Enter] to configure CPU Common options.

Thread Enablement

Press [Enter] to configure Thread Enablement options.

SMT Control

The item can be used to disable symmetric multithreading. To re-enable SMT, a POWER CYCLE is needed after selecting the "Auto" option.

Performance

Press [Enter] to configure Performance options.

Prefetcher Settings

Press [Enter] to configure Prefetcher Settings.

L1 Stream HW Prefetcher

Allows you to enable or disable L1 Stream HW Prefetcher.
Configuration options: [Auto] [Disabled] [Enabled]

L2 Stream HW Prefetcher

Allows you to enable or disable L2 Stream HW Prefetcher.
Configuration options: [Auto] [Disabled] [Enabled]

L1 Stride Prefetcher

Uses memory access history of individual instructions to fetch additional lines when each access is a constant distance from the previous.

Configuration options: [Auto] [Disabled] [Enabled]

L1 Region Prefetcher

Uses memory access history to fetch additional lines when the data access for a given instruction tends to be followed by other data accesses.

Configuration options: [Auto] [Disabled] [Enabled]

L2 Up/Down Prefetcher

Uses memory access history to determine whether to fetch the next or previous line for all memory accesses.

Configuration options: [Auto] [Disabled] [Enabled]

Core Watchdog

Press [Enter] to configure Core Watchdog options.

Core Watchdog Timer Enable

Allows you to enable or disable CPU Watchdog Timer.

Configuration options: [Auto] [Disabled] [Enabled]

Platform First Error Handling

Allows you to enable or disable PFEH, cloak individual banks, and mask deferred error interrupts from each bank.

Configuration options: [Auto] [Disabled] [Enabled]

Core Performance Boost

[Disabled] Select this item to disable CPB.

[Auto] BIOS will configure this setting automatically.

Global C-state Control

Allows you to control IO based C-state generation and DF C-state.

Configuration options: [Auto] [Disabled] [Enabled]

Opcache Control

Allows you to enable or disable the Opcache.

Configuration options: [Auto] [Disabled] [Enabled]

Streaming Stores Control

Allows you to enable or disable the streaming stores functionality.

Configuration options: [Auto] [Disabled] [Enabled]

Local APIC Mode

Allows you to select local APIC operation modes.

Configuration options: [Auto] [Compatibility] [xAPIC] [x2APIC]

ACPI_CST C1 Declaration

Allows you to determine whether or not to declare the C1 state to the OS.

Configuration options: [Auto] [Disabled] [Enabled]

MCA error thrash enable

Allows you to enable or disable MCA error thresholding.

Configuration options: [Auto] [Disabled] [Enabled]

SMU and PSP Debug Mode

When this option is enabled, uncorrected errors detected by the PSP FW or SMU FW that should cause a cold reset, will hang and not reset the system.

Configuration options: [Auto] [Disabled] [Enabled]

PPIN Opt-in

Allows you to enable or disable the PPIN feature.

Configuration options: [Auto] [Disabled] [Enabled]

Fast Short REP MOVSB

[Enabled] This is set to 1 as default.

[Disabled] This can be set to zero for analysis purposes as long as OS supports it.

Configuration options: [Disabled] [Enabled]

Enhanced REP MOVSB/STOSB

[Enabled] This is set to 1 as default.

[Disabled] This can be set to zero for analysis purposes as long as OS supports it.

Configuration options: [Disabled] [Enabled]

REP-MOV/STOS Streaming

Allows REP-MOV/STOS to use non-caching streaming stores for large sizes.

Configuration options: [Disabled] [Enabled]

Power Supply Idle Control

Allows you to configure Power Supply Idle Control.

Configuration options: [Auto] [Low Current Idle] [Typical Current Idle]

Xtring7 Workaround

This workaround is only applicable for Rev A. For Rev A, by default (Auto), the Bronze workaround is applied. Bronze workaround: DbReq and PDM function as expected; breakpoint redirect capability is compromised. Silver workaground: DbReq, PDM, and breakpoint redirect function as expected; SCAN capability is compromised. For Rev B, no workaround is applied and changing the selection for this option will not result in any change.

Configuration options: [Auto] [No Workaround] [Bronze Workaround] [Silver Workaround]

SNP Memory (RMP Table) Coverage

Use this item to configure the SNP Memory (RMP Table) Coverage. When [Enabled] is selected, the ENTIRE system memory is covered.

Configuration options: [Auto] [Disabled] [Enabled] [Custom]

SMEE

The item controls secure memory encryption enable.

Configuration options: [Auto] [Disabled] [Enabled]

Action on BIST Failure

The item allows you to select the action to take when a CCD BIST failure is detected.

Configuration options: [Auto] [Do nothing] [Down-CCD]

DF Common Options

Press [Enter] to configure DF Common options.

Memory Addressing

Press [Enter] to configure Memory Addressing options.

Memory interleaving

The item allows for disabling memory channel interleaving.

Memory interleaving size

The item controls the memory interleaving size. The valid values are AUTO, 256 bytes, 1 Kbytes or 2Kbytes. This determines the starting address of the interleave (bit 8, 9, 10 or 11).

DRAM map inversion

Inverting the map will cause the highest memory channels to get assigned the lowest addresses in the system.

Location of private memory regions

The item controls whether or not the private memory regions (PSP, SMU and CC6) are at the top of DRAM, at the top of 1st DRAM pair or distributed. Note that distributed requires memory on all dies. Note that it will always be at the top of DRAM if some dies don't have memory regardless of this option's setting.

Configuration options: [Auto] [Distributed] [Consolidated] [Consolidated to 1st DRAM pair]

Disable DF to external downstream IP Sync Flood Propagation

The item allows you to disable Error propagation to UMC or any downstream slaves eg. ECH. Use this to avoid reset in failure scenario.

Disable DF sync flood propagation

The item allows you to disable propagation from PIE to other DF components and eventually to SDP ports.

Configuration options: [Auto] [Sync flood disabled] [Sync flood enabled]

Freeze DF module queues on error

The item allows you to enable freezing of all DF queues on error and also forces a sync flood on HWA even if MCAs are disabled.

DR Cstates

When DF Cstate feature is enabled, FW programs the registers required to enable this feature. For auto option, it means this option will be synchronized with Global C State.

PSP error injection support

[True] Select this item to enable error injection.

[False] Select this item to disable error injection.

UMC Common Options

Press [Enter] to configure UMC Common options.

DDR Options

Press [Enter] to configure DDR Options.

DDR Timing Configuration

Press [Enter] to adjust DDR Timing configuration.

DDR Controller Configuration

Press [Enter] to adjust DDR Controller configuration.

DDR Power Options

Press [Enter] to configure DDR Power options.

Power Down Enable

Allows you to enable or disable DDR power down mode.

DDR RAS

Press [Enter] to configure DDR RAS options.

Disable Memory Error Injection

[True] Select this item to enable Memory Error Injection.

[False] Select this item to disable Memory Error Injection.

[Auto] Select this item to apply the default setting.

DDR ECC Configuration

Press [Enter] to adjust DDR ECC Configuration.

ECC

Allows you to enable or disable ECC. Auto will set ECC to be enabled.

Configuration options: [Auto] [Disabled] [Enabled]

DDR Security

Press [Enter] to configure DDR Security options.

TSME

Allows you to configure TSME setting.

Configuration options: [Auto] [Disabled] [Enabled]

Data Scramble

Allows you to configure Data Scramble setting.

Configuration options: [Auto] [Disabled] [Enabled]

DDR Addressing Options

Press [Enter] to configure DDR Addressing Options.

Chipselect Interleaving

Interleaves memory blocks across the DRAM chip selected for node 0.

Configuration options: [Auto] [Disabled]

Address Hash Bank

Allows you to enable or disable bank address hashing.

Configuration options: [Auto] [Disabled] [Enabled]

Address Hash CS

Allows you to enable or disable CS address hashing.

Configuration options: [Auto] [Disabled] [Enabled]

BankSwapMode

Allows you to configure BankSwapMode.

Configuration options: [Auto] [Disabled] [Swap APU]

DDR Training Options

Press [Enter] to configure DDR Training Options.

DFE Read Training

The item performs 2D Read Training with DFE on.

Configuration options: [Auto] [Disabled] [Enabled]

DRAM PDA Enumerate ID Programming Mode

Allows you to configure DRAM PDA Enumerate ID Programming Mode.

Configuration options: [Auto] [Sequential PDA enumeration mode] [Legacy PDA enumeration mode]

DDR Memory MBIST

Press [Enter] to configure DDR Memory MBIST.

MBIST Enable

Allows you to enable or disable Memory MBIST.

Configuration options: [Auto] [Disabled] [Enabled]

MBIST Test Mode

Allows you to select MBIST Test Mode - Interface Mode (Tests Single and Multiple CS transactions and Basic Connectivity) or Data Eye Mode (Measure Volage vs. Timing).

Configuration options: [Auto] [Interface Mode] [Data Eye Mode] [Both]

MBIST Aggressors

Allows you to enable or disable MBIST aggressor test.

Configuration options: [Auto] [Disabled] [Enabled]

MBIST Per Bit Slave Die Reporting

When it is enabled, it reports 2D Data Eye Results in ABL Log for each DQ, Chipselect and Channel.

Configuration options: [Auto] [Disabled] [Enabled]

DDR Data Eye

Press [Enter] to configure DDR Data Eye options.

Pattern Select

Allows you to configure Pattern Select.

Configuration options: [PRBS] [SSO] [Both]

Pattern Length

This token helps to determine the pattern length. The possible options are N=3...12.

Aggressor Channel

This helps to read the aggressors channels. If it is enabled, you can read from one or more than one aggressor channel.

Configuration options: [Disabled] [1 Aggressor Channel] [3 Aggressor Channels] [7 Aggressor Channels]

DDR Memory Features

Press [Enter] to configure DDR Memory Features.

Memory Context Restore

Allows you to configure the mermoy context restore mode. When it is enabled, DRAM re-retaining is avoided if possible and the POST latency is minimized.

Configuration options: [Auto] [Disabled] [Enabled]

NBIO Common Options

Press [Enter] to configure NBIO Common options.

IOMMU

Allows you to enable or disable IOMMU.

Configuration options: [Auto] [Disabled] [Enabled]

PCIe ARI Support

Allows you to enable or disable PCIe ARI Support.

Configuration options: [Auto] [Disabled] [Enabled]

PCIe ARI Enumeration

Allows you to enable or disable ARI Forwarding for each downstream port.

Configuration options: [Auto] [Disabled] [Enabled]

PSPP Policy

Allows you to enable or disable PSPP Policy.

Configuration options: [Auto] [Disabled] [Enabled]

GFX Configuration

Press [Enter] to configure GFX Configuration.

iGPU Configuration

Allows you to select the UMA mode.

Configuration options: [Auto] [iGPU Disabled] [UMA_SPECIFIED] [UMA_AUTO]
[UMA_GAME_OPTIMIZED]

UMA Version

Allows you to select UMA Version.

[Legacy] Select this item for UMA Legacy Version.

[Non-Legacy] Select this item for UMA Non Legacy Version.

[Auto] Select this item for Hybrid Secure.

GPU Host Translation Cache

Allows you to enable or disable GPU Host Translation Cache.

Configuration options: [Auto] [Disabled] [Enabled]

Audio Configuration

Press [Enter] to configure Audio Configuration.

Configuration options: [Auto] [Disabled] [Enabled]

NB Azalia

Allows you to enable or disable HD Audio controller.

Configuration options: [Auto] [Disabled] [Enabled]

Audio IOs

Allows you to configure Audio IOs controls.

PCIe loopback Mode

Allows you to enable or disable PCIe loopback Mode.

Configuration options: [Auto] [Disabled] [Enabled]

FCH Common Options

Press [Enter] to configure FCH Common options.

USB Configuration Options

Press [Enter] to configure USB Configuration Options.

USB0 controller enable

Allows you to enable or disable USB0 controller.

USB1 controller enable

Allows you to enable or disable USB1 controller.

USB2 controller enable

Allows you to enable or disable USB2 controller.

USB0 2.0 port enable

Press [Enter] to configure USB0 2.0 port enable options.

USB0 2.0 port 0

Allows you to enable or disable USB0 2.0 port 0.

USB0 2.0 port 1

Allows you to enable or disable USB0 2.0 port 1.

USB1 2.0 port enable

Press [Enter] to configure USB1 2.0 port enable options.

USB1 2.0 port 0

Allows you to enable or disable USB1 2.0 port 0.

USB1 2.0 port 1

Allows you to enable or disable USB1 2.0 port 1.

USB2 2.0 port enable

Press [Enter] to configure USB2 2.0 port enable options.

USB2 2.0 port 0

Allows you to enable or disable USB2 2.0 port 0.

USB0 3.1 port enable

Press [Enter] to configure USB0 3.1 port enable options.

USB0 3.1 port 0

Allows you to enable or disable USB0 3.1 port 0.

USB0 3.1 port 1

Allows you to enable or disable USB0 3.1 port 1.

USB1 3.1 port enable

Press [Enter] to configure USB1 3.1 port enable options.

USB1 3.1 port 0

Allows you to enable or disable USB1 3.1 port 0.

USB1 3.1 port 1

Allows you to enable or disable USB1 3.1 port 1.

FCH Spread Spectrum

Allows you to select whether or not enable the Spread Spectrum Feature.

SMU Common Options

Press [Enter] to configure SMU Common Options.

TDP Control

[Auto] Select this item to use the default sustained power limit.

[Manual] Select this item to set customized sustained power limit.

PPT Control

[Auto] Select this item to use the default PPT Limits.

[Manual] Select this item to set customized PPT Limits.

Thermal Control

[Auto] Select this item to use the default TctlMax.

[Manual] Select this item to set customized TctlMax.

TDC Control

[Auto] Select this item to use the default TDC limits.

[Manual] Select this item to set customized TDC limits.

EDC Control

[Auto] Select this item to use the default EDC limits.

[Manual] Select this item to set customized EDC limits.

PROCHOT Control

[Auto] Select this item to use the default PROCHOT deassertion ramp time.

[Manual] Select this item to set customized PROCHOT deassertion ramp time.

VDDP Voltage Control

[Auto] Select this item to use the default VDDP voltage.

[Manual] Select this item to set customized VDDP voltage.

Infinity Fabric Frequency and Dividers

Allows you to set Infinity Fabric Frequency and Dividers.

[Auto] BIOS will configure this setting automatically.

FEATURE FCLK DPM

Allows you to enable or disable FEATURE FCLK DPM.

Configuration options: [Auto] [Disabled] [Enabled]

SyncFifo Mode Override

Allows you to enable or disable SyncFifo Mode Override. When it is set to [Auto], SyncFifo Mode is disabled.

Configuration options: [Auto] [Disabled] [Enabled]

Soc Miscellaneous Control

Press [Enter] to configure Soc Miscellaneous Control.

ABL Console Out Control

[Enabled] Select this item to enable ConsoleOut Function for ABL.

[Disabled] Select this item to disable ConsoleOut Function for ABL.

PROM21 Chipset Common Options

Press [Enter] to configure Chipset Common options.

PROM21 Chipset PCIe Port Configuration Options

Press [Enter] to configure PROM21 Chipset PCIe Port Configuration Options.

PROM21 Chipset SATA Configuration Options

Press [Enter] to configure PROM21 Chipset SATA Configuration Options.

PROM21 Chipset USB Configuration Options

Press [Enter] to configure PROM21 Chipset USB Configuration Options.

PROM21L.1/3 USB Port Configuration Options

Press [Enter] to configure PROM21L.1/3 USB Port Configuration Options.

PROM21 Chipset SI Configuration Options

Press [Enter] to configure PROM21 Chipset SI Configuration Options.

Secondary PROM21 Chipset PCIe Port Configuration Options

Press [Enter] to configure PROM21 Chipset PCIe Port Configuration Options.

Secondary PROM21 Chipset SATA Configuration Options

Press [Enter] to configure PROM21 Chipset SATA Configuration Options.

Secondary PROM21 Chipset USB Configuration Options

Press [Enter] to configure PROM21 Chipset USB Configuration Options.

Secondary PROM21L.1/3 USB Port Configuration Options

Press [Enter] to configure PROM21L.1/3 USB Port Configuration Options.

Secondary PROM21 Chipset SI Configuration Options

Press [Enter] to configure PROM21 Chipset SI Configuration Options.

PROM21 Chipset Revision

Allows you to configure PROM21 Chipset Revision setting.

Configuration options: [Auto] [A1] [A2]

Dual PROM21 port number/disable

Allows you to set downstream port number for the second PROM21.

Configuration options: [Auto] [Disable] [Port 0] [Port 4] [Port 8]

3.4.8 AMD PBS

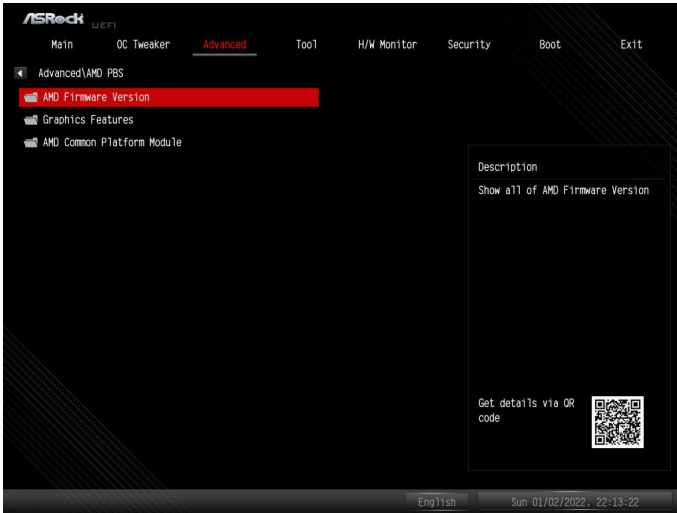

AMD Firmware Version

Press [Enter] to view information of all AMD Firmware versions.

Graphics Features

Press [Enter] to configure Graphics Features - HG, DGPU Features, and BOMACO.

Primary Video Adaptor

Allows you to select Internal/External Graphics. Default setting is [Int Graphics (IGD)].

Configuration options: [Int Graphics (IGD)] [Ext Graphics (PEG)]

AMD Common Platform Module

Press [Enter] to configure AMB Common Platform Module options. BIOS procedure library is designed to aid AMD customers to quickly implement AMD platform technology into their products.

PCIe/GFX Lane Configuration

Allows you to configure J10 Slot PCIe Lanes.

Configuration options: [Auto] [x8x8] [x8x4x4] [x4x4x4x4]

PCIe/GFX Lane Configuration

Allows you to configure PCIe x16 Link Speed.

Configuration options: [Auto] [Gen1]-[Gen5]

M.2_1 Link Speed

Allows you to configure M.2_1 Link Speed.

Configuration options: [Auto] [Gen1]-[Gen5]

Chipset Link Speed

Allows you to configure Chipset Link Speed.

Configuration options: [Auto] [Gen1]-[Gen4]

UCSI Support

[Enable] Select this item to enable UCSI (USB Type-C Connector System Software Interface).

[Disable] Select this item to disable UCSI (USB Type-C Connector System Software Interface).

External CLK Control

Allows you to configure External CLK Control.

Configuration options: [Auto] [eCLK0, GPP0-PCIe, GPP0-CPU] [eCLK1, GPP0-PCIe, GPP1-CPU]

Note: Switch APU clocks source mapping will get stuck immediately (post code: B0005A5A). Manully press cold reset button to bypass the stuck.

NVMe RAID mode

Allows you to enable or disable NVMe RAID mode. Please set the "PCIe/GFX Lanes Configuration" item according to the RAID configuration.

Configuration options: [Disabled] [Enabled]

Adjust VddcrVddfull Mode

Allows you to configure VddcrVddfull mode.

Configuration options: [Auto] [Manual]

Adjust VddcrSocfull Mode

Allows you to configure VddcrSocfull mode.

Configuration options: [Auto] [Manual]

Thunderbolt Support

[Enable] Select this item to enable the Thunderbolt support.

[Disable] Select this item to disable the Thunderbolt support.

Security Level

Allows you to select the Security Level.

Configuration options: [No Security] [User Authorization] [Secure Connect]

[Display Port only]

Debug Print In ASL

[Enabled] Select this item to enable Debug Print In ASL.

[Disabled] Select this item to disable Debug Print In ASL.

3.4.9 AMD Overclocking

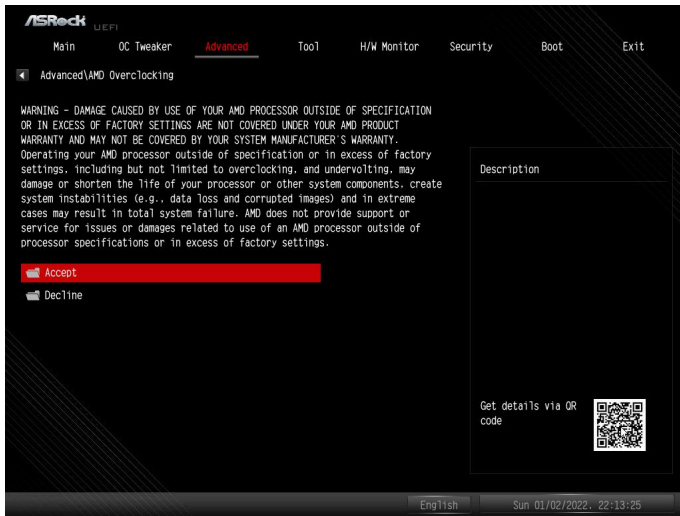

The AMD Overclocking menu accesses options for configuring CPU frequency and voltage.

3.5 Tool

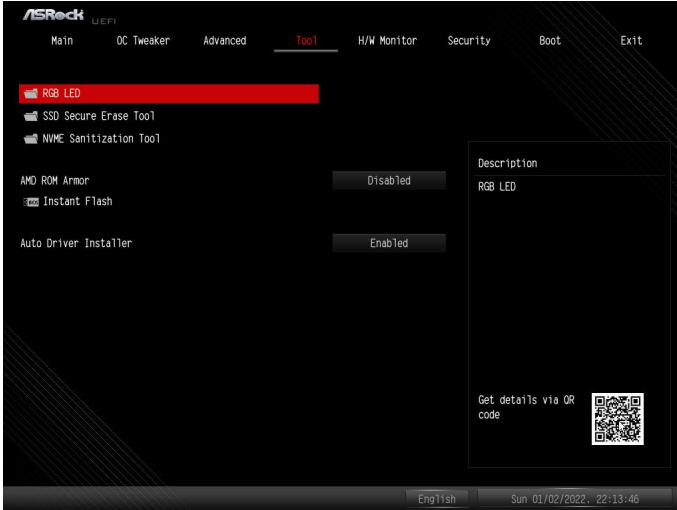

RGB LED

Press [Enter] configure RGB LED options.

RGB LED Mode

Allows you to configure LED Mode.

Configuration options: [Off] [Static] [Breathing] [Strobe] [Cycling] [Wave] [Spring] [Stack] [Cram] [Scan] [Neon] [Water] [Rainbow]

Speed

Allows you to configure LED speed, in a range from 0 to 255.

Brightness

Allows you to configure LED brightness, in a range from 0 to 255.

SSD Secure Erase Tool

Use this tool to securely erase SSD. This tool only lists the SSDs that support the Secure Erase function.

NVME Sanitization Tool

After you Sanitize SSD, all user data will be permanently destroyed on the SSD and cannot be recovered.

AMD ROM Armor

Allows you to enable or diable AMD ROM Armor support.

Instant Flash

Allows you to save UEFI files in your USB storage device and run Instant Flash to update your UEFI.

Auto Driver Installer

Allows you to download and install all necessary drivers automatically.

[Enabled] Select this item to enable the Auto Driver Installer tool. When it is enabled, after entering to Windows with available Internet access, the Auto Driver Installer tool will appear automatically.

[Disabled] Select this item to disable the Auto Driver Installer tool.

3.6 Hardware Health Event Monitoring Screen

This section allows you to monitor the status of the hardware on your system, including the parameters of the CPU temperature, motherboard temperature, fan speed and voltage.

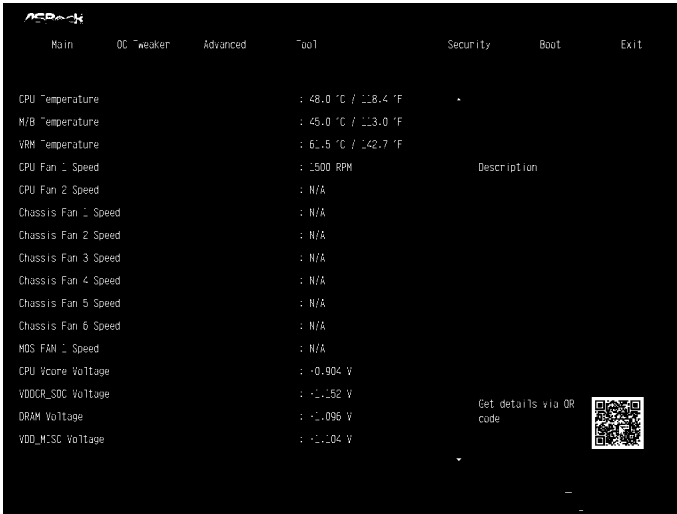

NOTE: Options vary depending on the features of your motherboard.

CPU_FAN1 Setting

Allows you to select a fan mode for CPU Fan 1, or choose [Customize] to set 5 CPU temperatures and assign a respective fan speed for each temperature.

Configuration options:

[Customize] [Silent Mode] [Standard Mode] [Performance Mode] [Full Speed]

CPU_FAN2/WP Switch

Allows you to select CPU Water Pump mode.

CPU Fan 2 Control Mode

Allows you to select PWM mode or DC mode for CPU Fan 2.

[Auto] Select this mode to detect the type of installed fan and automatically switch the control modes.

[DC Mode] Select this mode for 3-pin fan.

[PWM Mode] Select this mode for 4-pin fan.

CPU Fan 2 Setting

Allows you to select a fan mode for CPU Fan 2, or choose [Customize] to set 5 CPU temperatures and assign a respective fan speed for each temperature.

Configuration options:

[Customize] [Silent Mode] [Standard Mode] [Performance Mode] [Full Speed]

CPU Fan 2 Temp Source

Allows you to select a fan temperature source for CPU Fan.

[Monitor M/B] Select this item to set motherboard as the fan temperature source.

[Monitor CPU] Select this item to set CPU as the fan temperature source.

CHA_FAN1/WP Switch

Allows you to select CHA_FAN1 or Water Pump mode.

Chassis Fan 1 Control Mode

Allows you to select PWM mode or DC mode for Chassis Fan 1.

[Auto] Select this mode to detect the type of installed fan and automatically switch the control modes.

[DC Mode] Select this mode for 3-pin fan.

[PWM Mode] Select this mode for 4-pin fan.

Chassis Fan 1 Setting

Allows you to select a fan mode for Chassis Fan 1, or choose [Customize] to set 5 CPU temperatures and assign a respective fan speed for each temperature.

Configuration options:

[Customize] [Silent Mode] [Standard Mode] [Performance Mode] [Full Speed]

Chassis Fan 1 Temp Source

Allows you to select a fan temperature source for Chassis Fan 1.

[Monitor M/B] Select this item to set motherboard as the fan temperature source.

[Monitor CPU] Select this item to set CPU as the fan temperature source.

CHA_FAN2/WP Switch

Allows you to select CHA_FAN2 or Water Pump mode.

Chassis Fan 2 Control Mode

Allows you to select PWM mode or DC mode for Chassis Fan 2.

[Auto] Select this mode to detect the type of installed fan and automatically switch the control modes.

[DC Mode] Select this mode for 3-pin fan.

[PWM Mode] Select this mode for 4-pin fan.

Chassis Fan 2 Setting

Allows you to select a fan mode for Chassis Fan 2, or choose [Customize] to set 5 CPU temperatures and assign a respective fan speed for each temperature.

Configuration options:

[Customize] [Silent Mode] [Standard Mode] [Performance Mode] [Full Speed]

Chassis Fan 2 Temp Source

Allows you to select a fan temperature source for Chassis Fan 2.

[Monitor M/B] Select this item to set motherboard as the fan temperature source.

[Monitor CPU] Select this item to set CPU as the fan temperature source.

CHA_FAN3/WP Switch

Allows you to select CHA_FAN3 or Water Pump mode.

Chassis Fan 3 Control Mode

Allows you to select PWM mode or DC mode for Chassis Fan 3.

[Auto] Select this mode to detect the type of installed fan and automatically switch the control modes.

[DC Mode] Select this mode for 3-pin fan.

[PWM Mode] Select this mode for 4-pin fan.

Chassis Fan 3 Setting

Allows you to select a fan mode for Chassis Fan 3, or choose [Customize] to set 5 CPU temperatures and assign a respective fan speed for each temperature.

Configuration options:

[Customize] [Silent Mode] [Standard Mode] [Performance Mode] [Full Speed]

Chassis Fan 3 Temp Source

Allows you to select a fan temperature source for Chassis Fan 3.

[Monitor M/B] Select this item to set motherboard as the fan temperature source.

[Monitor CPU] Select this item to set CPU as the fan temperature source.

CHA_FAN4/WP Switch

Allows you to select CHA_FAN4 or Water Pump mode.

Chassis Fan 4 Control Mode

Allows you to select PWM mode or DC mode for Chassis Fan 4.

[Auto] Select this mode to detect the type of installed fan and automatically switch the control modes.

[DC Mode] Select this mode for 3-pin fan.

[PWM Mode] Select this mode for 4-pin fan.

Chassis Fan 4 Setting

Allows you to select a fan mode for Chassis Fan 4, or choose [Customize] to set 5 CPU temperatures and assign a respective fan speed for each temperature.

Configuration options:

[Customize] [Silent Mode] [Standard Mode] [Performance Mode] [Full Speed]

CHA_FAN5/WP Switch

Allows you to select CHA_FAN5 or Water Pump mode.

Chassis Fan 5 Control Mode

Allows you to select PWM mode or DC mode for Chassis Fan 5.

[Auto] Select this mode to detect the type of installed fan and automatically switch the control modes.

[DC Mode] Select this mode for 3-pin fan.

[PWM Mode] Select this mode for 4-pin fan.

Chassis Fan 5 Setting

Allows you to select a fan mode for Chassis Fan 5, or choose [Customize] to set 5 CPU temperatures and assign a respective fan speed for each temperature.

Configuration options:

[Customize] [Silent Mode] [Standard Mode] [Performance Mode] [Full Speed]

CHA_FAN6/WP Switch

Allows you to select CHA_FAN6 or Water Pump mode.

Chassis Fan 6 Control Mode

Allows you to select PWM mode or DC mode for Chassis Fan 6.

[Auto] Select this mode to detect the type of installed fan and automatically switch the control modes.

[DC Mode] Select this mode for 3-pin fan.

[PWM Mode] Select this mode for 4-pin fan.

Chassis Fan 6 Setting

Allows you to select a fan mode for Chassis Fan 6, or choose [Customize] to set 5 CPU temperatures and assign a respective fan speed for each temperature.

Configuration options:

[Customize] [Silent Mode] [Standard Mode] [Performance Mode] [Full Speed]

MOS FAN 1 Setting

Allows you to select a fan mode for Fan, or choose [Customize] to set 5 CPU temperatures and assign a respective fan speed for each temperature.

Configuration options:

[Customize] [Silent Mode] [Standard Mode] [Performance Mode] [Full Speed]

MOS FAN 1 Temp Source

Allows you to select Fan Temperature Source.

[Monitor M/B] Select this item to set motherboard as the fan temperature source.

[Monitor CPU] Select this item to set CPU as the fan temperature source.

Fan-Tastic

Allows you to select a fan mode for Fan, or choose [Customize] to set 5 CPU temperatures and assign a respective fan speed for each temperature.

Select a fan mode or customize the profile

The screenshot shows the ASRock UEFI Fan-Tastic configuration screen. It features a red background and a central graph showing fan speed (%) on the y-axis (0 to 100) versus temperature (°C) on the x-axis (0 to 100). The graph displays a curve that starts at approximately 40% fan speed at 50°C and rises to 100% at 100°C. The interface includes several interactive elements:

- Mode Selection:** A horizontal bar at the top contains four modes: "Silent", "Standard", "Performance", and "Full Speed".
- Temperature Source:** Two buttons, "Monitor CPU" and "Monitor M/B", are located above the graph.
- Fan Selection:** A vertical list on the left side, titled "All Fans Setting", includes "CPU Fan 1", "CPU Fan 2", and "Chassis Fan 1" through "Chassis Fan 6".
- Control Buttons:** At the bottom right, there are "Discard", "Apply", and "Exit" buttons.

Annotations with orange lines point to these elements:

- "Select a fan mode or customize the profile" points to the mode selection bar.
- "Select a fan temperature source" points to the "Monitor CPU" and "Monitor M/B" buttons.
- "Select Fan(s) to adjust" points to the "All Fans Setting" list.
- "Save the setting" points to the "Apply" button.

FanTuning

When selected, the BIOS will proceed to detect the lowest fan speeds for fans connected to the motherboard. This process will take a few minutes to complete.

Note: Please note CAM settings applied within the OS will overwrite settings made within the BIOS.

3.7 Security Screen

In this section you may set or change the supervisor/user password for the system. You may also clear the user password.

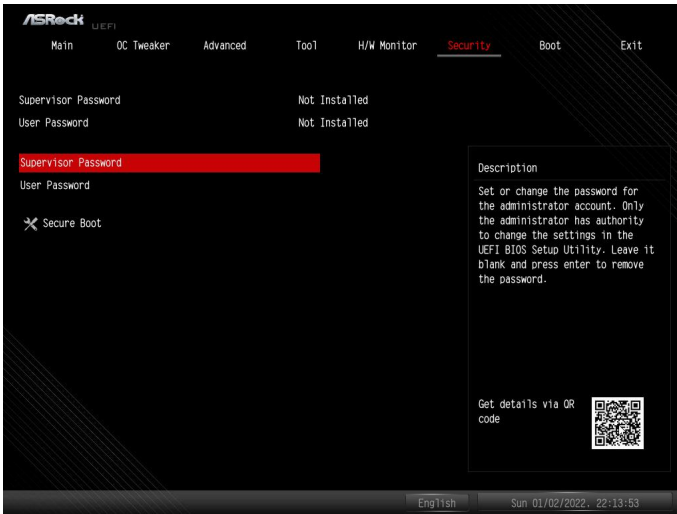

Supervisor Password

Set or change the password for the administrator account. Only the administrator has authority to change the settings in the UEFI Setup Utility. Leave it blank and press enter to remove the password.

User Password

Set or change the password for the user account. Users are unable to change the settings in the UEFI Setup Utility. Leave it blank and press enter to remove the password.

Secure Boot

Press [Enter] to configure the Secure Boot Settings. The feature protects the system from unauthorized access and malwares during POST.

Secure Boot Mode

[Standard] Select this item and the system will automatically load the Secure Boot keys from the BIOS database.

[Custom] Select this item and Secure Boot Policy variables can be configured by a physically present user without full authentication.

Install Default Secure Boot Keys

Please install default secure boot keys if it's the first time you use secure boot.

Clear Secure Boot Keys

This item appears only when you load the default Secure Boot keys. Use this item to clear all default Secure Boot keys.

Key Management

This item enables expert users to modify Secure Boot Policy variables without full authentication. This appears only when you set Secure Boot Mode to [Custom].

Factory Key Provision

Allows you to install factory default Secure Boot keys after the platform reset and while the System is in Setup mode.

Install Default Secure Boot Keys

Please install default secure boot keys if it's the first time you use secure boot.

Clear Secure Boot Keys

This item appears only when you load the default Secure Boot keys. Use this item to clear all default Secure Boot keys.

Export Secure Boot variables

Allows you to copy NVRAM content of Secure Boot variables to files in a root folder on a file_system device.

Enroll Efi Image

Allows the image to run in Secure Boot mode. Enroll SHA256 hash of the binary into Authorized Signature Database (db).

Device Guard Ready

Remove 'UEFI CA' from DB

Device Guard ready system must not list 'Microsoft UEFI CA' Certificate in Authorized Signature database (db).

Restore DB defaults

Allows you to restore DB variable to factory defaults.

Platform Key(PK)

Enroll Factory Defaults or load certificates from a file:

1. Public Key Certificate:

- a) EFI_SIGNATURE_LIST
- b) EFI_CERT_X509 (DER)
- c) EFI_CERT_RSA2048 (bin)
- d) EFI_CERT_SHAXXX

2. Authenticated UEFI Variable

3. EFI PE/COFF Image(SHA256)

Key Source: Factory, External, Mixed

Key Exchange Keys

Enroll Factory Defaults or load certificates from a file:

1. Public Key Certificate:

- a) EFI_SIGNATURE_LIST
- b) EFI_CERT_X509 (DER)
- c) EFI_CERT_RSA2048 (bin)
- d) EFI_CERT_SHAXXX

2. Authenticated UEFI Variable

3. EFI PE/COFF Image(SHA256)

Key Source: Factory, External, Mixed

Authorized Signatures

Enroll Factory Defaults or load certificates from a file:

1. Public Key Certificate:

- a) EFI_SIGNATURE_LIST
- b) EFI_CERT_X509 (DER)
- c) EFI_CERT_RSA2048 (bin)
- d) EFI_CERT_SHAXXX

2. Authenticated UEFI Variable

3. EFI PE/COFF Image(SHA256)

Key Source: Factory, External, Mixed

Forbidden Signatures

Enroll Factory Defaults or load certificates from a file:

1. Public Key Certificate:
 - a) EFI_SIGNATURE_LIST
 - b) EFI_CERT_X509 (DER)
 - c) EFI_CERT_RSA2048 (bin)
 - d) EFI_CERT_SHAXXX
2. Authenticated UEFI Variable
3. EFI PE/COFF Image(SHA256)

Key Source: Factory, External, Mixed

Authorized TimeStamps

Enroll Factory Defaults or load certificates from a file:

1. Public Key Certificate:
 - a) EFI_SIGNATURE_LIST
 - b) EFI_CERT_X509 (DER)
 - c) EFI_CERT_RSA2048 (bin)
 - d) EFI_CERT_SHAXXX
2. Authenticated UEFI Variable
3. EFI PE/COFF Image(SHA256)

Key Source: Factory, External, Mixed

OsRecovery Signatures

Enroll Factory Defaults or load certificates from a file:

1. Public Key Certificate:
 - a) EFI_SIGNATURE_LIST
 - b) EFI_CERT_X509 (DER)
 - c) EFI_CERT_RSA2048 (bin)
 - d) EFI_CERT_SHAXXX
2. Authenticated UEFI Variable
3. EFI PE/COFF Image(SHA256)

Key Source: Factory, External, Mixed

3.8 Boot Screen

This section displays the available devices on your system for you to configure the boot settings and the boot priority.



CSM

CSM (Compatibility Support Module) is enabled for better compatibility for the non-UEFI driver add-on devices. If you are using UEFI aware OS and all of your devices support UEFI, you may also disable CSM for faster boot speed.

Configuration options: [Disabled] [Enabled]

Launch PXE OpROM Policy

[UEFI only] Select this item to run those that support UEFI option ROM only.

[Do not launch] Select this item to not execute both legacy and UEFI option ROM.

Launch Storage OpROM Policy

[UEFI only] Select this item to run those that support UEFI option ROM only.

[Do not launch] Select this item to not execute both legacy and UEFI option ROM.

Setup Prompt Timeout

Allows you to configure the number of seconds to wait for the UEFI setup utility.

Bootup Num-Lock

Allows you to select whether Num Lock should be turned on or off when the system boots up.

Full Screen Logo

[Enabled] Select this item to display the boot logo.

[Disabled] Select this item to show normal POST messages.

Fast Boot

Fast Boot speeds up your computer's boot time; however you won't be able to boot from an USB storage device. Ultra Fast mode is supported by UEFI aware OS or later versions, and a VBIOS that supports UEFI GOP is required if you are using an external graphics card. Please note that Ultra Fast mode boots so fast that the only way to enter this UEFI Setup Utility is to clear CMOS or run the Restart to UEFI utility in Windows.

Configuration options: [Disabled] [Ultra Fast]

3.9 Exit Screen

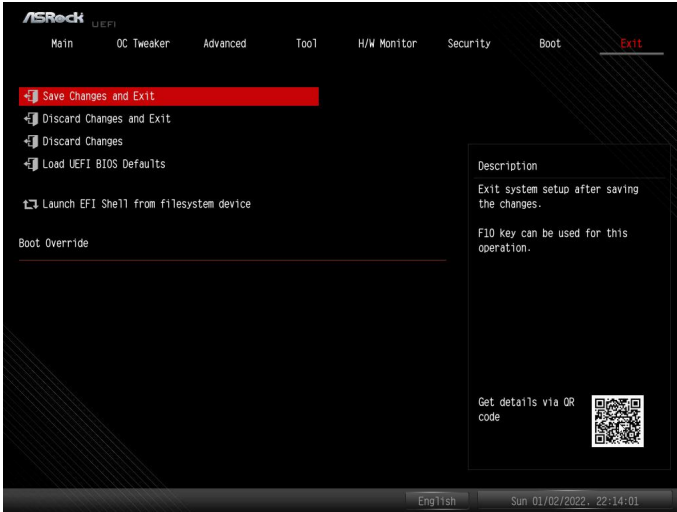

Save Changes and Exit

When you select this option the following message, “Save configuration changes and exit setup?” will pop out. Press <F10> key or select [Yes] to save the changes and exit the UEFI SETUP UTILITY.

Discard Changes and Exit

When you select this option the following message, “Discard changes and exit setup?” will pop out. Press <ESC> key or select [Yes] to exit the UEFI SETUP UTILITY without saving any changes.

Discard Changes

When you select this option the following message, “Discard changes?” will pop out. Press <F7> key or select [Yes] to discard all changes.

Load UEFI Defaults

Allows you to load UEFI default values for all options. The F9 key can be used for this operation.

Launch EFI Shell from filesystem device

Allows you to copy shellx64.efi to the root directory to launch EFI Shell.