



Digital Projector User Manual

Warranty and Copyright information

Limited warranty

BenQ warrants this product against any defects in material and workmanship, under normal usage and storage.

Proof of purchase date will be required with any warranty claim. In the event this product is found to be defective within the warranty period, BenQ's only obligation and your exclusive remedy shall be replacement of any defective parts (labor included). To obtain warranty service, immediately notify the dealer from which you purchased the product of any defects.

Important: The above warranty shall be void if the customer fails to operate the product in accordance with BenQ's written instructions, especially the ambient humidity must be in-between 10% and 90%, temperature in-between 0°C and 35°C, altitude lower than 4920 feet, and avoiding to operate the projector in a dusty environment. This warranty gives you specific legal rights, and you may have other rights which vary from country to country.

For other information, please visit www.BenQ.com.

Copyright

Copyright © 2022 by BenQ Corporation. All rights reserved. No part of this publication may be reproduced, transmitted, transcribed, stored in a retrieval system or translated into any language or computer language, in any form or by any means, electronic, mechanical, magnetic, optical, chemical, manual or otherwise, without the prior written permission of BenQ Corporation.

Disclaimer

BenQ Corporation makes no representations or warranties, either expressed or implied, with respect to the contents hereof and specifically disclaims any warranties, merchantability or fitness for any particular purpose. Further, BenQ Corporation reserves the right to revise this publication and to make changes from time to time in the contents hereof without obligation to notify any person of such revision or changes.

*DLP, Digital Micromirror Device and DMD are trademarks of Texas Instruments. Others are copyrights of their respective companies or organizations.

Patents

Please go to <http://patmarking.benq.com/> for the details on BenQ projector patent coverage.



Table of Contents

Warranty and Copyright information	2
Important safety instructions	4
Introduction	7
Shipping contents	7
Projector exterior view	8
Controls and functions.....	9
Positioning your projector	11
Choosing a location	11
Obtaining a preferred projected image size.....	12
Shifting the projection lens	13
Mounting the projector	13
Adjusting the projected image.....	15
Connection	16
Operation	17
Starting up the projector	17
Using the menus	19
Upgrading firmware	20
Switching input signal.....	21
Presenting from a Media Reader.....	22
Shutting down the projector	23
Direct power off	23
Menu operation	24
Basic menu	24
Advanced menu	26
Maintenance	35
Care of the projector	35
Lamp information	35
Troubleshooting	42
Specifications	43
Projector specifications	43
Dimensions	44
Timing chart.....	45

Important safety instructions

Your projector is designed and tested to meet the latest standards for safety of information technology equipment. However, to ensure safe use of this product, it is important that you follow the instructions mentioned in this manual and marked on the product.

1. **Please read this manual before you operate your projector.** Save it for future reference.

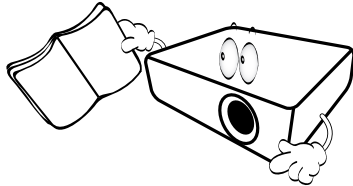

2. **Do not look straight at the projector lens during operation.** The intense light beam may damage your eyes.

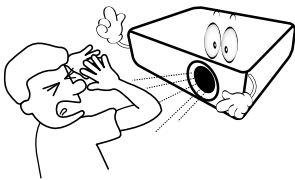

3. **Refer servicing to qualified service personnel.**

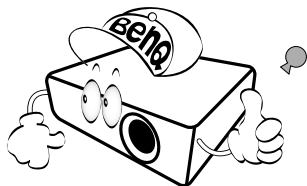

4. **Always open the lens shutter (if any) or remove the lens cap (if any) when the projector lamp is on.**

5. The lamp becomes extremely hot during operation. Allow the projector to cool for approximately 45 minutes prior to removing the lamp assembly for replacement.

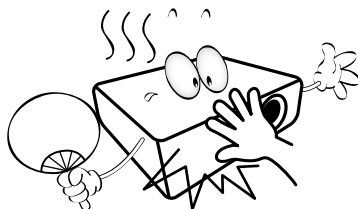

6. In some countries, the line voltage is NOT stable. This projector is designed to operate safely within a mains voltage between 100 to 240 volts AC, but could fail if power cuts or surges of ± 10 volts occur. **In areas where the mains voltage may fluctuate or cut out, it is recommended that you connect your projector through a power stabilizer, surge protector or uninterruptible power supply (UPS).**

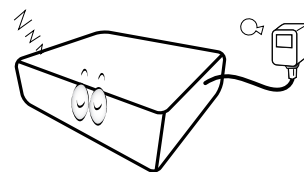

7. Do not block the projection lens with any objects when the projector is under operation as this could cause the objects to become heated and deformed or even cause a fire. To temporarily turn off the lamp, use the blank function.

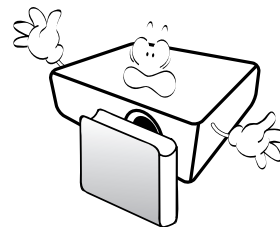

8. Do not operate lamps beyond the rated lamp life. Excessive operation of lamps beyond the rated life could cause them to break on rare occasions.

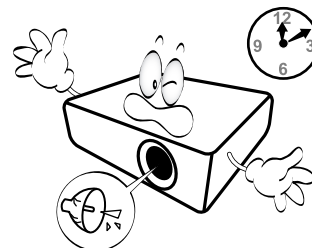

9. Never replace the lamp assembly or any electronic components unless the projector is unplugged.

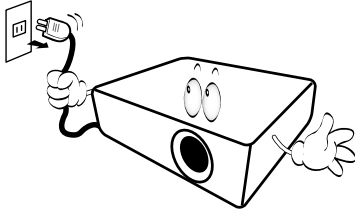

10. Do not place this product on an unstable cart, stand, or table. The product may fall, sustaining serious damage.

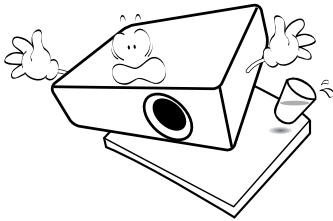

11. Do not attempt to disassemble this projector. There are dangerous high voltages inside which may cause death if you should come into contact with live parts. The only user serviceable part is the lamp which has its own removable cover.

Under no circumstances should you ever undo or remove any other covers. Refer servicing only to suitably qualified professional service personnel.

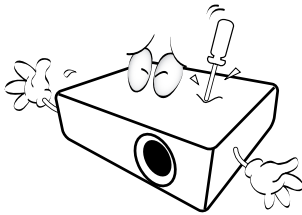

12. Do not block the ventilation holes.

- Do not place this projector on a blanket, bedding or any other soft surface.
- Do not cover this projector with a cloth or any other item.
- Do not place inflammables near the projector.

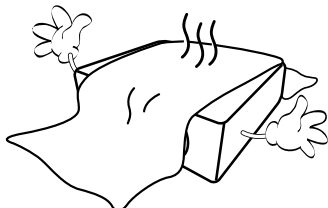

If the ventilation holes are seriously obstructed, overheating inside the projector may result in a fire.

13. Always place the projector on a level, horizontal surface during operation.

- Do not use if tilted at an angle of more than 10 degrees left to right, nor at angle of more than 15 degrees front to back. Using the projector when it is not fully horizontal may cause a malfunction of, or damage to, the lamp.

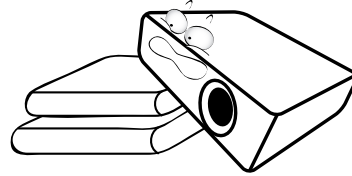

14. Do not stand the projector on end vertically. Doing so may cause the projector to fall over, causing injury or resulting in damage to the projector.

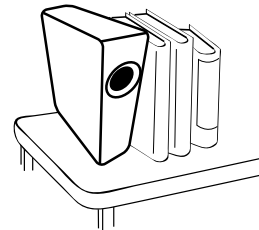

15. Do not step on the projector or place any objects upon it. Besides probable physical damage to the projector, doing so may result in accidents and possible injury.

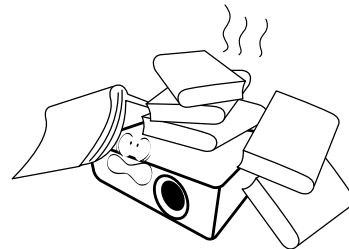

16. When the projector is under operation, you may sense some heated air and odor from its ventilation grill. It is a normal phenomenon and not a product defect.

17. Do not place liquids near or on the projector. Liquids spilled into the projector may cause it to fail. If the projector does become wet, disconnect it from the power supply's power outlet and call BenQ to have the projector serviced.

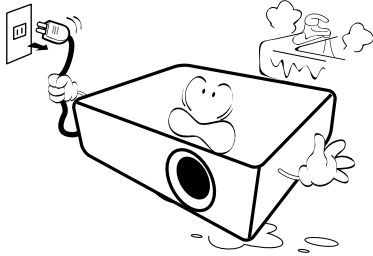

18. This product is capable of displaying inverted images for ceiling/wall mount installation.

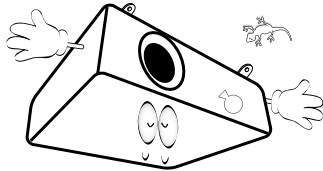

19. This apparatus must be earthed.



- Hg - Lamp contains mercury. Manage in accordance with local disposal laws. See www.lamprecycle.org.
- To avoid damaging the DLP chips, never aim a high-power laser beam into the projection lens.

20. Do not place this projector in any of the following environments.

- Space that is poorly ventilated or confined. Allow at least 50 cm clearance from walls and free flow of air around the projector.
- Locations where temperatures may become excessively high, such as the inside of a car with all windows rolled up.
- Locations where excessive humidity, dust, or cigarette smoke may contaminate optical components, shorten the projector's life span and darken the image.

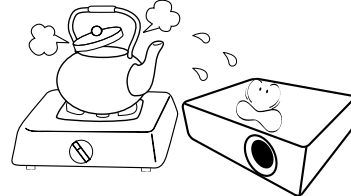

- Locations near fire alarms
- Locations with an ambient temperature above 40°C / 104°F
- Locations where the altitudes are higher than 3000 m (10000 feet).

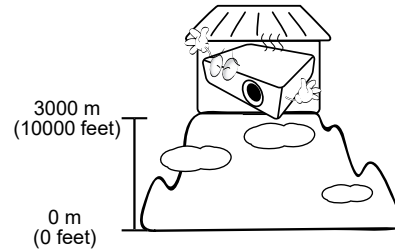

Introduction

Shipping contents

Carefully unpack and verify that you have all of the items shown below. If any of these items are missing, please contact your place of purchase.

Standard accessories

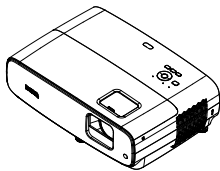

Projector

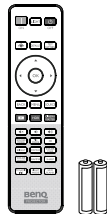

Remote control with batteries

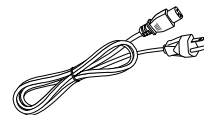

Power cord

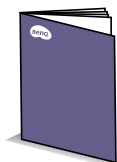

Quick start guide



Warranty card*



• The supplied accessories will be suitable for your region, and may differ from those illustrated.

• *The warranty card is only supplied in some specific regions. Please consult your dealer for detailed information.

Optional accessories

1. Spare lamp kit

2. 3D glasses

Replacing the remote control batteries

1. Press and open the battery cover, as illustrated.
2. Remove the old batteries (if applicable) and install two AAA batteries. Make sure that the positive and negative ends are positioned correctly, as illustrated.
3. Replace the battery cover until it clicks into place.

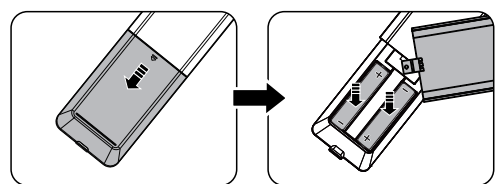

• Avoid leaving the remote control and batteries in an excessive heat or humid environment like the kitchen, bathroom, sauna, sunroom or in a closed car.

• Replace only with the same or equivalent type recommended by the battery manufacturer.

• Dispose of the used batteries according to the manufacturer's instructions and local environment regulations for your region.

• Never throw the batteries into a fire. There may be danger of an explosion.

• If the batteries are dead or if you will not be using the remote control for an extended period of time, remove the batteries to avoid damage to the remote control from possible battery leakage.

Projector exterior view

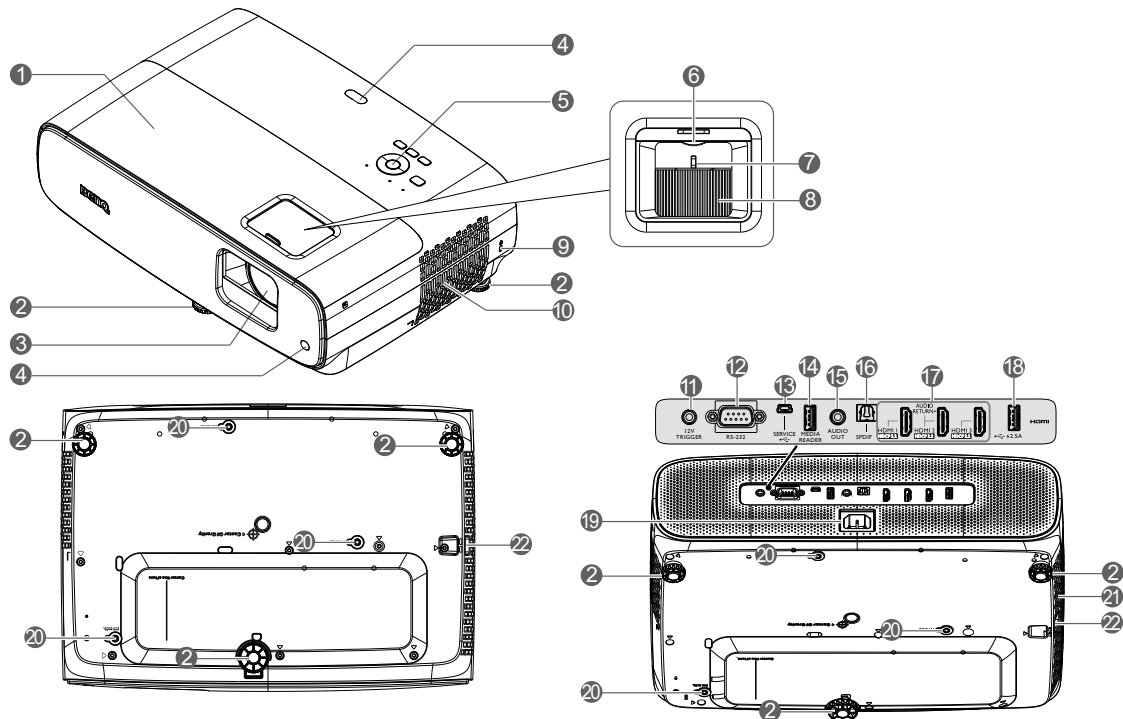

- 1. Lamp cover
- 2. Adjuster feet
- 3. Projection lens
- 4. IR remote sensor
- 5. External control panel
(See [Controls and functions](#) on page 9.)
- 6. Lens shift wheel
- 7. Zoom ring
- 8. Focus ring
- 9. Kensington anti-theft lock slot
- 10. Vent (air inlet)
- 11. 12V DC output terminal
Triggers external devices such as an electric screen or light control, etc.
- 12. RS-232 control port
- 13. USB Mini-B port (for firmware upgrades)
- 14. USB Type-A port (1.5A media reader/drive, firmware download)
- 15. Audio output jack
- 16. SPDIF output port
- 17. HDMI 1/ HDMI 2/ HDMI 3 input port (HDCP 2.2)
- 18. USB Type-A port (2.5A power supply)
- 19. AC power jack
- 20. Wall mount holes
- 21. Vent (air exhaust)
- 22. Security bar

Controls and functions

Projector & Remote control



All the key presses described in this document are available on the remote control or projector.

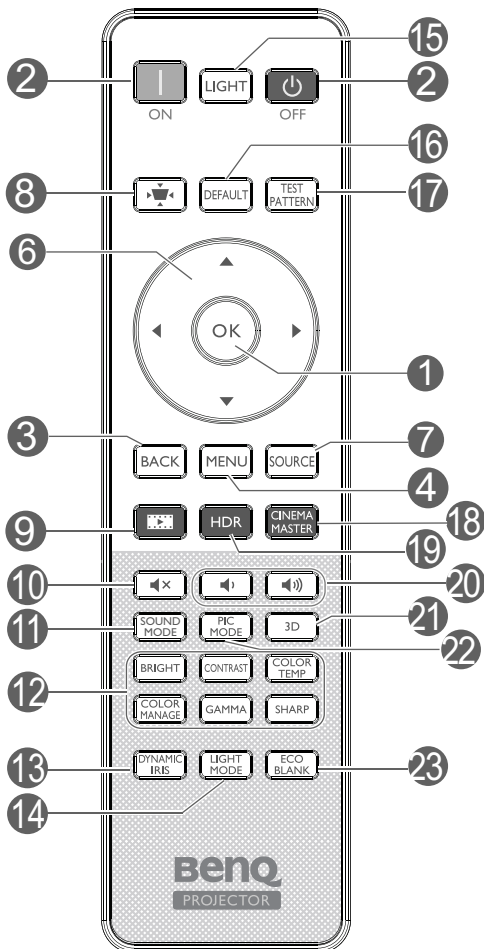
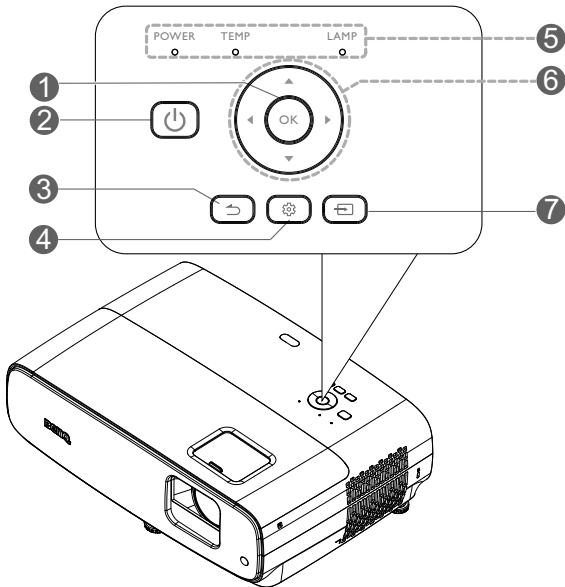

1. **OK**

Confirms the selected On-Screen Display (OSD) menu item.

When Keystone OSD pops up, long press for 2 seconds to reset Keystone.

2. **POWER**

Toggles the projector between standby mode and on.



Toggles the projector between standby mode and on.

3. **BACK**

Goes back to previous OSD menu, exits and saves menu settings.

4. **MENU**

Turns on the On-Screen Display (OSD) menu.

5. **POWER indicator light/TEMPERature warning light/LAMP indicator light** (See [Indicators on page 41.](#))

6. Arrow keys (▲, ▼, ◀, ▶)

When the On-Screen Display (OSD) menu is activated, these keys are used as directional arrows to select the desired menu items and to make adjustments.

7. **SOURCE**

Displays the source selection bar.

8. **2D Keystone correction key**

Displays the 2D Keystone correction menu.

9. **Filmmaker**

Switch Picture Mode to Filmmaker Mode. Available on compatible projectors only.

10. **Audio icon**

Toggles projector audio between on and off.

11. SOUND MODE

Displays the **SOUND MODE** menu.

12. Picture quality adjustment keys (**BRIGHT, CONTRAST, COLOR TEMP, COLOR MANAGE, GAMMA, SHARP**)

Displays the setting bars for adjustments of the appropriate picture quality values.

13. DYNAMIC IRIS

Selects a suitable **DYNAMIC IRIS** among the provided modes.

14. LIGHT MODE

Selects a suitable lamp power from among the provided modes.

15. LIGHT

Turns on the remote control backlight for a few seconds. To keep the backlight on, press any other key while the backlight is on. Press the key again to turn the backlight off.

16. DEFAULT

Resets to default value for all of adjustment bars menu when doing adjustment.

17. TEST PATTERN

Displays the **TEST PATTERN**.

18. CINEMA MASTER

Displays the CinemaMaster menu.

19. HDR

Displays the **HDR** menu.

20. Volume keys

Decreases or increases the projector volume.

21. 3D

Displays the **3D** menu.

22. PIC MODE

Displays the **Picture Mode** menu.

When Keystone OSD pops up, long press for 2 seconds to enable Auto Keystone.

23. ECO BLANK

Used to hide the screen picture.



Do not block the projection lens from projecting as this could cause the blocking object to become heated and deformed or even cause a fire.

Remote control effective range

The remote control must be held at an angle within 30 degrees perpendicular to the projector's IR remote control sensor(s) to function correctly. The distance between the remote control and the sensor(s) should not exceed 8 meters (~ 26 feet).

Make sure that there are no obstacles between the remote control and the IR sensor(s) on the projector that might obstruct the infra-red beam.

- Operating the projector from the front

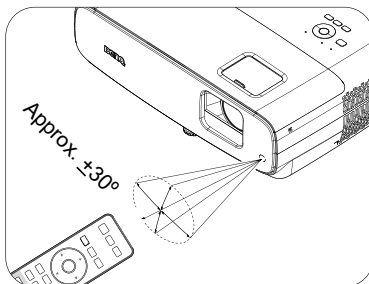

- Operating the projector from the top

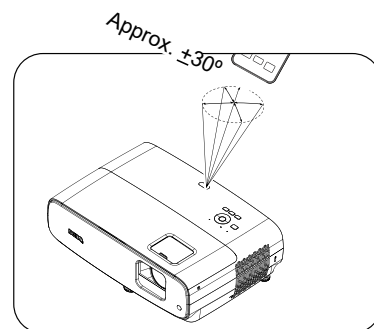

Positioning your projector

Choosing a location

Before choosing an installation location for your projector, take the following factors into consideration:

- Size and position of your screen
- Electrical outlet location
- Location and distance between the projector and the rest of your equipment

The projected image size and vertical offset depend on how far you place the projector, and the zoom setting you choose. The table and diagram from [Projection dimensions on page 12](#) can help decide exact distance and height of your projector

You can install your projector in the following ways.

1. Front Table

Select this location with the projector placed on the table in front of the screen. This is the most common way to position the projector for quick setup and portability.

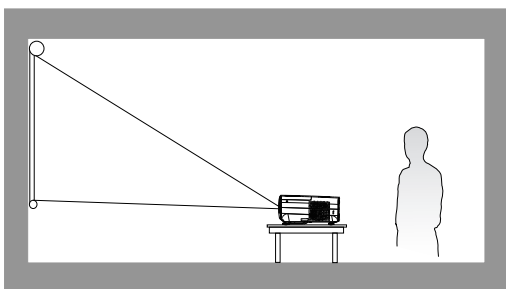

2. Rear Table

Select this location with the projector placed on the table behind the screen. Note that a special rear projection screen is required.

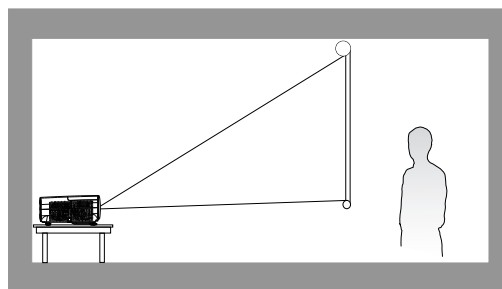

3. Front Ceiling

Select this location with the projector suspended upside-down in front of the screen. Purchase the BenQ Projector Ceiling/Wall Mount Kit from your dealer to mount your projector.

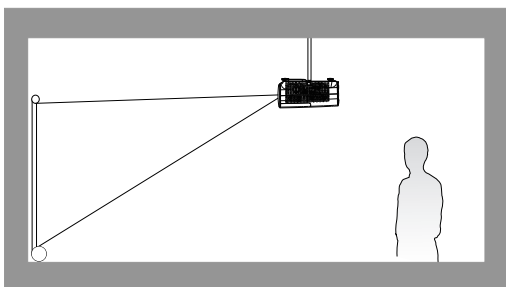

4. Rear Ceiling

Select this location with the projector suspended upside-down from behind the screen. Note that a special rear projection screen and the BenQ Projector Ceiling/Wall Mount Kit are required for this installation location.

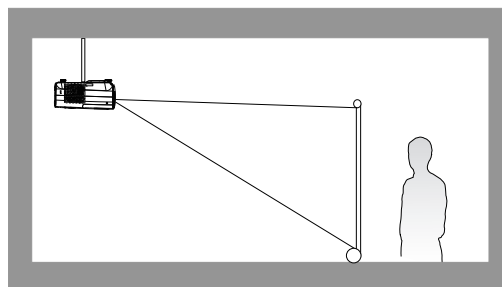

After turning on the projector, go to **Advanced menu - Installation Menu > Projector Position** and press ◀/▶ to select a setting.

Obtaining a preferred projected image size

The distance from the projector lens to the screen, the zoom setting (if available), and the video format each factors in the projected image size.

Projection dimensions

- The screen aspect ratio is 16:9 and the projected picture is in a 16:9 aspect ratio

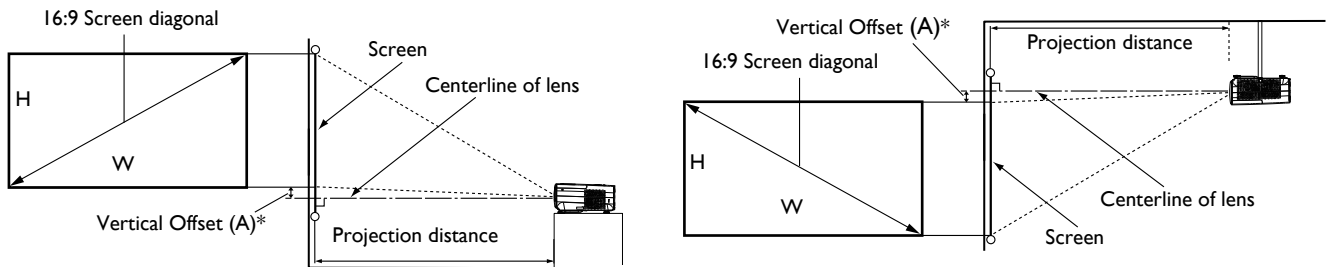

- *The vertical offset value is the vertical distance from the bottom edge of the image (when the projector is on a table, diagram on the left), or top edge of the image (when the projector is ceiling mounted, diagram on the right) to the centerline of lens.
- Due to the lens optical characteristics, every projector has its vertical offset ratio. The vertical offset value normally gets larger while the projection distance increases.

Screen size				Distance from screen (mm)			*Vertical offset (A)
Diagonal		H (mm)	W (mm)	Min length	Average	Max length	Distance between center of lens to image border (mm)
Inch	mm			(max. zoom)		(min. zoom)	
30	762	374	664	750	863	976	0 - 37
40	1016	498	886	1001	1151	1302	0 - 50
50	1270	623	1107	1251	1439	1627	0 - 62
60	1524	747	1328	1501	1727	1953	0 - 75
70	1778	872	1550	1751	2015	2278	0 - 87
80	2032	996	1771	2001	2302	2603	0 - 100
90	2286	1121	1992	2251	2590	2929	0 - 112
100	2540	1245	2214	2502	2878	3254	0 - 125
110	2794	1370	2435	2752	3166	3580	0 - 137
120	3048	1494	2657	3002	3454	3905	0 - 150
130	3302	1619	2878	3252	3741	4231	0 - 162
140	3556	1743	3099	3502	4029	4556	0 - 175
150	3810	1868	3321	3752	4317	4881	0 - 187
160	4064	1992	3542	4003	4605	5207	0 - 199
170	4318	2117	3763	4253	4893	5532	0 - 212
180	4572	2241	3985	4503	5180	5858	0 - 224
190	4826	2366	4206	4753	5468	6183	0 - 237
200	5080	2491	4428	5003	5756	6509	0 - 249
210	5334	2615	4649	5253	6044	6834	0 - 262
220	5588	2740	4870	5504	6331	7159	0 - 274
230	5842	2864	5092	5754	6619	7485	0 - 287
240	6096	2989	5313	6004	6907	7810	0 - 299
250	6350	3113	5535	6254	7195	8136	0 - 312
260	6604	3238	5756	6504	7483	8461	0 - 324
270	6858	3362	5977	6754	7770	8787	0 - 337
280	7112	3487	6199	7004	8058	9112	0 - 349

290	7366	3611	6420	7255	8346	9437	0 - 361
300	7620	3736	6641	7505	8634	9763	0 - 374

For example, if you are using a 120-inch screen, the recommended projection distance is 3454 mm.

If your measured projection distance is 5000 mm, the closest match in the "Distance from screen (mm)" column is 5180 mm. Looking across this row shows that a 180" (about 4.6 m) screen is required. The projected image will be slightly higher/lower than the lens centerline with 125 mm vertical offset.



- All measurements are approximate and may vary from the actual sizes. BenQ recommends that if you intend to permanently install the projector, you should physically test the projection size and distance using the actual projector in situ before you permanently install it, so as to make allowance for this projector's optical characteristics. This will help you determine the exact mounting position so that it best suits your installation location.
- To optimize your projection quality, we suggest doing the projection by following the values in the non-gray cells.
- The values in the gray cells are for reference only.

Shifting the projection lens

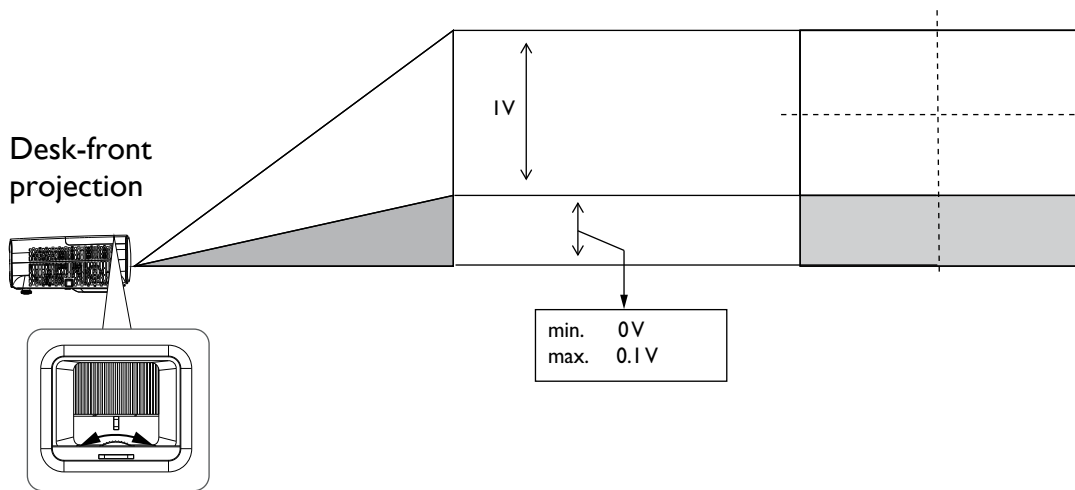

- Please stop turning the adjustment knob when you hear a clicking sound indicating the knob has reached its limit. Over-turning the knob may cause damage.

Mounting the projector

If you intend to mount your projector, we strongly recommend that you use a proper fitting BenQ projector mounting kit and that you ensure it is securely and safely installed.

If you use a non-BenQ brand projector mounting kit, there is a safety risk that the projector may fall down due to an improper attachment through the use of the wrong gauge or length screws.

Before mounting the projector

- Purchase a BenQ projector mounting kit from the place you purchased your BenQ projector.
- BenQ recommends that you also purchase a separate Kensington lock compatible security cable and attach it securely to both the Kensington lock slot on the projector and the base of the mounting bracket. This will perform the secondary role of restraining the projector should its attachment to the mounting bracket become loose.
- Ask your dealer to install the projector for you. Installing the projector on your own may cause it to fall and result in injury.

- Take necessary procedures to prevent the projector from falling off such as during an earthquake.
- The warranty doesn't cover any product damage caused by mounting the projector with a non-BenQ brand projector mounting kit.
- Consider the surrounding temperature where the projector is ceiling/wall mounted. If a heater is used, the temperature around the ceiling/wall may be higher than expected.
- Read the user manual for the mounting kit about the range of torque. Tightening with torque exceeding the recommended range may cause damage to the projector and subsequently falling off.
- Make sure the power outlet is at an accessible height so that you can easily shut down the projector.

Ceiling/Wall mount installation diagram

Ceiling/Wall mount screw: M4
(Max L = 25 mm; Min L = 20 mm)

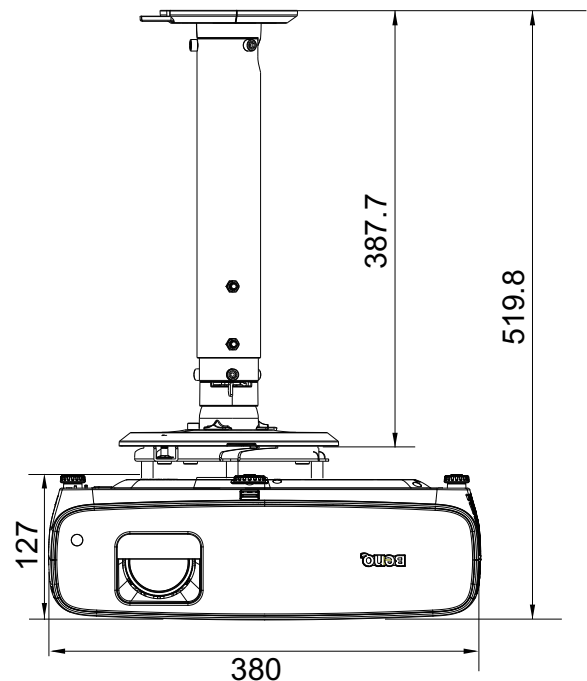
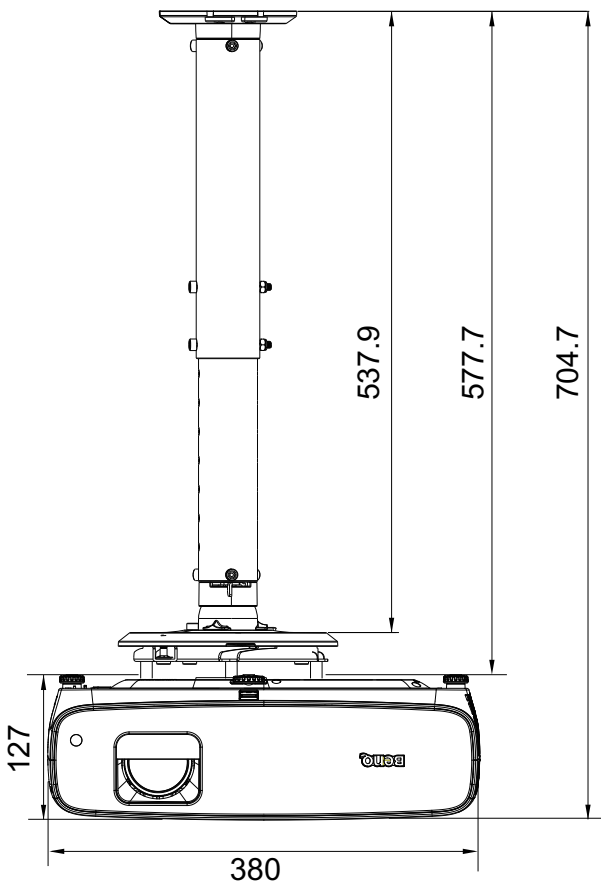
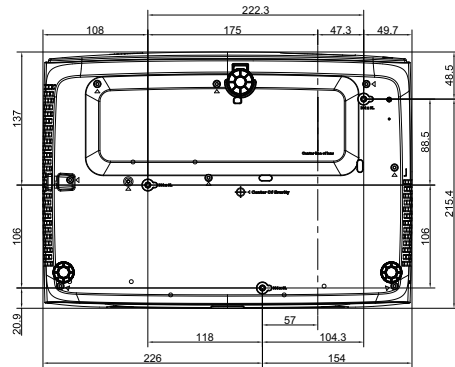

Unit: mm

Adjusting the projected image

Adjusting the projection angle

If the projector is not placed on a flat surface or the screen and the projector are not perpendicular to each other, the projected image becomes trapezoidal. You can screw the adjuster feet to fine-tune the horizontal angle.

To retract the feet, screw the adjuster feet in a reverse direction.

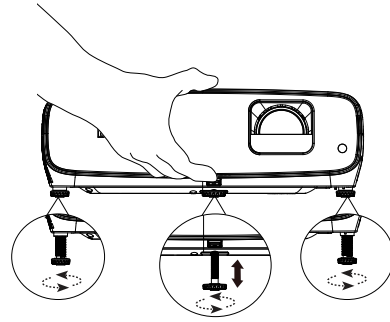

! Do not look into the lens while the lamp is on. The strong light from the lamp may cause damage to your eyes.

Fine-tuning the image size and clarity

Adjust the projected image to the size that you need using the zoom ring.

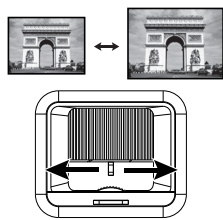

Sharpen the image by rotating the focus ring.

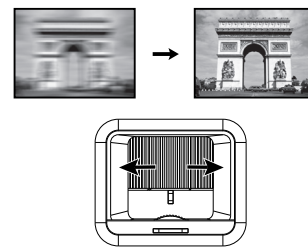

Correcting keystone

Keystoning refers to the situation where the projected image becomes a trapezoid due to angled projection.

To correct the distorted image:

1. Display the **2D Keystone** correction from the following menus.

- The setup wizard during the projector initial setup
- The **Basic** menu
- The **Installation** menu of the **Advanced** menu

2. After the **2D Keystone** correction page appears:

- To correct keystone at the top of the image, use ▼.
- To correct keystone at the bottom of the image, use ▲.
- To correct keystone at the right side of the image, use ◀.
- To correct keystone at the left side of the image, use ▶.
- To automatically correct the vertical sides of the distorted image, press **OK** for 2 seconds.

3. When done, press **BACK** to save your changes and exit.

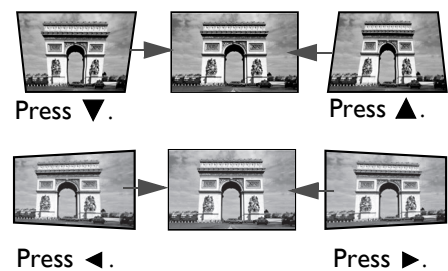

Connection

When connecting a signal source to the projector, be sure to:

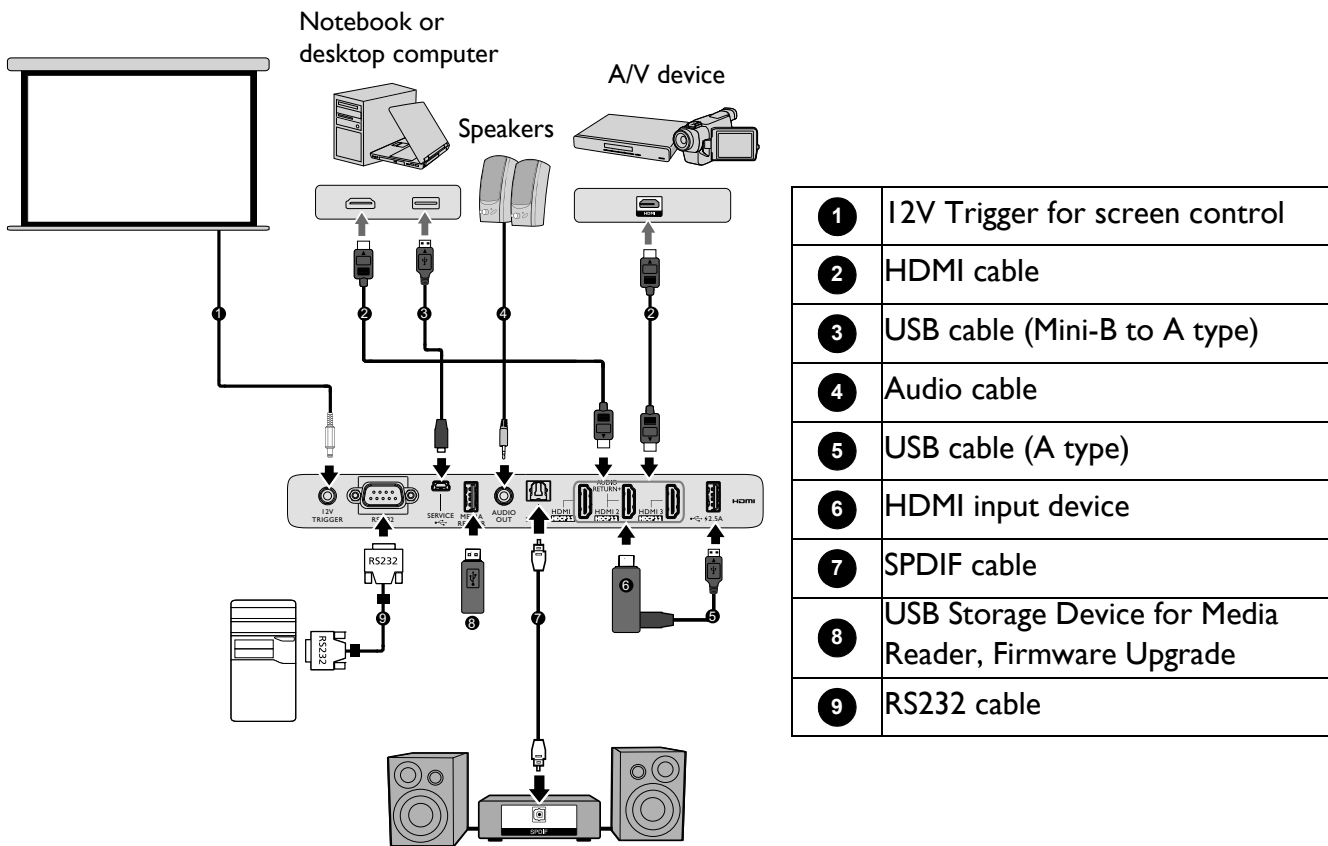

1. Turn all equipment off before making any connections.
2. Use the correct signal cables for each source.
3. Ensure the cables are firmly inserted.



- In the connections above, some cables may not be included with the projector (see [Shipping contents on page 7](#)). They are commercially available from electronics stores.
- The connection illustrations are for reference only. The rear connecting jacks available on the projector vary with each projector model.
- Many notebooks do not turn on their external video ports when connected to a projector. Usually a key combo like FN + function key with a monitor symbol turns the external display on/off. Press FN and the labeled function key simultaneously. Refer to your notebook's documentation to find your notebook's key combination.
- If the selected video image is not displayed after the projector is turned on and the correct video source has been selected, check that the video source device is turned on and operating correctly. Also check that the signal cables have been connected correctly.
- The built-in speaker(s) will be muted when the AUDIO OUT jack is connected.
- Please check your computer's baud rate at 9600 so that you can connect the projector by using a suitable RS-232 cable.

Operation



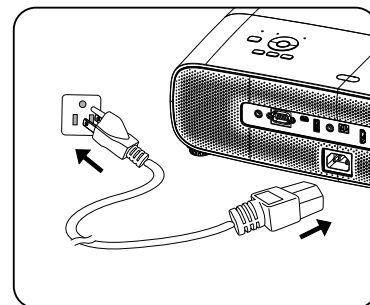

Starting up the projector

1. Plug the power cord. Turn on the power outlet switch (where fitted). The power indicator on the projector lights orange after power has been applied.
2. Press  on the projector or  on the remote control to start the projector. The power indicator flashes green and stays green when the projector is on.



The start up procedure takes within one minute. In the later stage of start up, a startup logo is projected.

(If necessary) Rotate the focus ring to adjust the image clearness.

3. If this is the first time you turn on the projector, the setup wizard appears to guide you through setting up the projector. If you have already done this, skip this step and move on to the next step.
 - Use the arrow keys (, , , ) on the projector or remote control to move through the menu items.
 - Use **OK** to confirm the selected menu item.

Step 1:

Specify **Projector Position**.

For more information about projector position, see [Choosing a location](#).

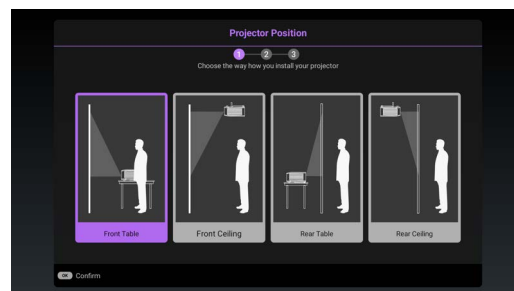

Step 2:

Specify OSD **Language**.

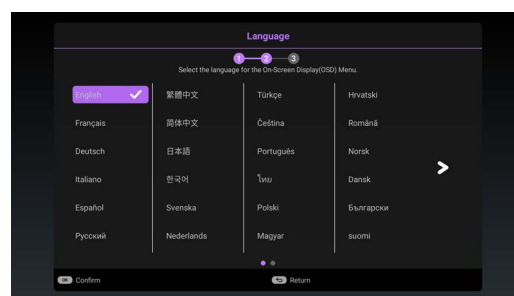

Step 3:

Specify **2D Keystone**.

For more information about keystone, see [Correcting keystone](#).

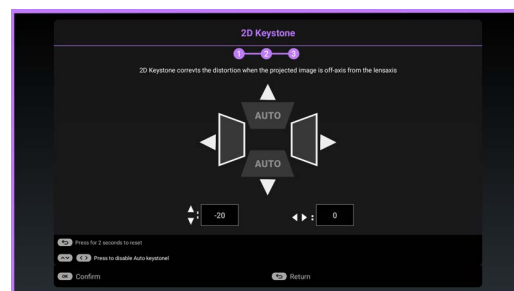

4. If you are prompted for a password, press the arrow keys to enter a 6-digit password. See [Utilizing the password function on page 21](#).
5. Switch all of the connected equipment on.
6. The projector will search for input signals and detect if a signal is available from the input source that was last used and switch to that input source if it is available, if a signal is not available, the projector will display Source menu.

You can also press **SOURCE** to select your desired input signal. See [Switching input signal on page 21](#).



- Please use the original accessories (e.g. power cord) to avoid possible dangers such as electric shock and fire.
- If the projector is still hot from previous activity, it will run the cooling fan for approximately 90 seconds before energizing the lamp.



-
- The Setup Wizard screenshots are for reference only and may differ from the actual design.
 - If the frequency/resolution of the input signal exceeds the projector's operating range, you will see the message "Out of Range" displayed on the background screen. Please change to an input signal which is compatible with the projector's resolution or set the input signal to a lower setting. See [Timing chart on page 45](#).
 - If no signal is detected for 3 minutes, the projector automatically enters saving mode.

Using the menus

The projector is equipped with On-Screen Display (OSD) menus for making various adjustments and settings.

- **Basic** OSD menu: provides primary menu functions. (See [Basic menu on page 24](#))
- **Advanced** OSD menu: provides full menu functions. (See [Advanced menu on page 26](#))

To access the OSD menu, press **MENU**.

- Use the arrow keys (▲/▼/◀/▶) on the projector or remote control to move through the menu items.
- Use **OK** on the projector or remote control to confirm the selected menu item.

The first time you use the projector (after finishing the initial setup), **Basic** OSD menu displays.



The OSD screenshots below are for reference only, and may differ from the actual design.

Below is the overview of the **Basic** OSD menu.

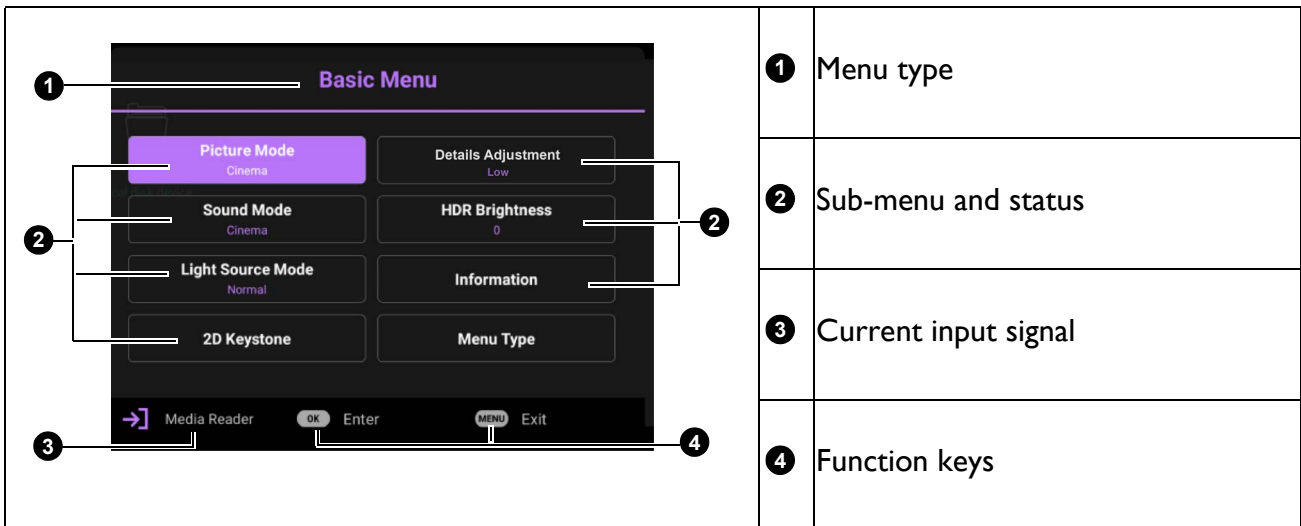

If you intend to switch from the **Basic** OSD menu to the **Advanced** OSD menu, follow the instructions below:

1. Go to **Basic Menu > Menu Type**.
2. Press **OK** and press ▲/▼ to select **Advanced**. Next time when you turn on the projector, you may access the **Advanced** OSD menu by pressing **MENU**.

Below is the overview of the **Advanced** OSD menu.

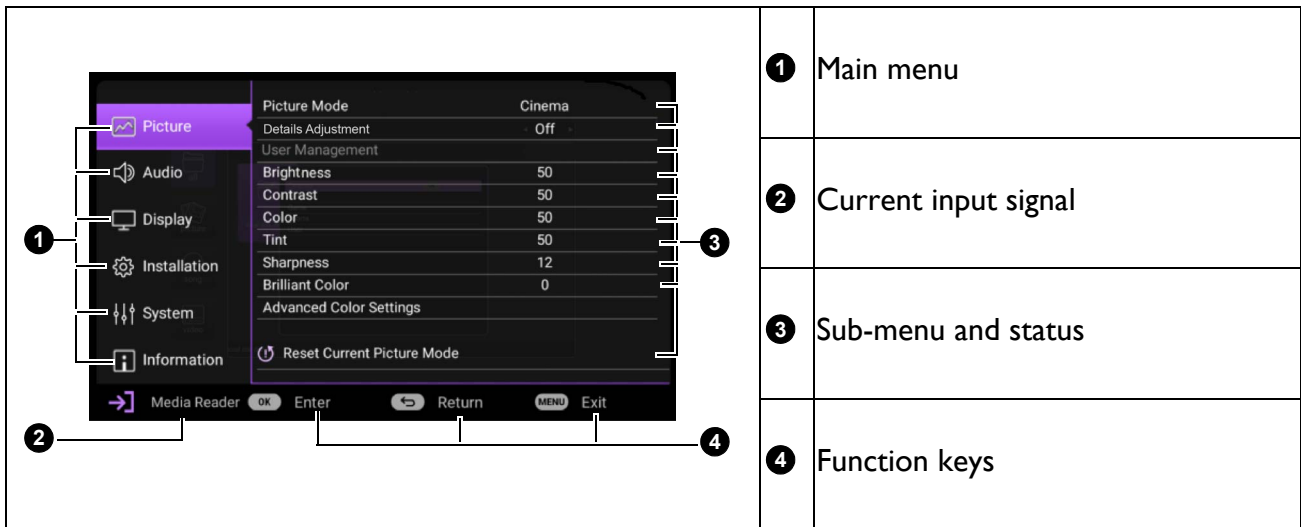

Likewise, when you wish to switch from the **Advanced** OSD menu to the **Basic** OSD menu, follow the instructions below:

1. Go to **Advanced Menu - System > Menu Settings** and press **OK**.
2. Select **Menu Type** and **OK**.
3. Press **▲/▼** to select **Basic**. Next time when you turn on the projector, you may access the **Basic** OSD menu by pressing **MENU**.

To access the OSD menu, press **MENU**.

- Use the arrow keys (**▲/▼**) on the projector or remote control to move through the main menu items.
- Use the arrow keys (**▲/▼**) on the projector or remote control to move through the sub-menu items.
- Use the arrow keys (**◀/▶**) on the projector or remote control to adjust the settings or press **OK** on the projector or remote control to enter the sub-menu.
- Press **MENU** twice* to leave and save the settings.

*The first press leads you back to the main menu and the second press closes the OSD menu.

Upgrading firmware

1. Go to BenQ Website and enter into **Product page > Support > Software** to download the latest firmware file.
2. Unzip the download file, find and save the file named "TK860Upgrade.bin" to the USB flash drive. (Suggest to use the USB flash drive with FAT32 format)
3. Insert USB flash drive into **MEDIA READER** port.
4. Go to **Advanced Menu - System > Firmware Upgrade** menu and press **OK**.
5. Select **Yes** to upgrade the firmware version. In the process of upgrading, please keep power on until updating finished.

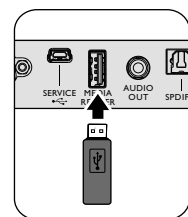

Switching input signal

The projector can be connected to multiple devices at the same time. However, it can only display one full screen at a time. When starting up, the projector automatically searches for the available signals.

Be sure the **Advanced Menu - System > Display > Auto Source Search** menu is **On** if you want the projector to automatically search for the signals.

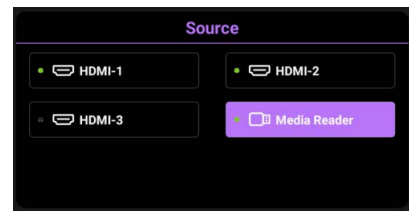

To select the source:

1. Press **SOURCE**. A source selection bar appears.
2. Press **▲/▼/◀/▶** until your desired signal is selected and press **OK**.

Once detected, the selected source information will appear at the corner of the screen for seconds. If there is multiple equipment connected to the projector, repeat steps 1-2 to search for another signal.



- The brightness level of the projected image will change accordingly when you switch between different input signals.
- For best display picture results, you should select and use an input signal which outputs at the projector's native resolution. Any other resolutions will be scaled by the projector depending upon the "aspect ratio" setting, which may cause some image distortion or loss of picture clarity. See [High Altitude Mode on page 33](#).

Presenting from a Media Reader

The USB port on the projector allows you to browse the image and document files stored on a USB flash drive connected to the projector. It can eliminate the need for a computer source.





Supported files formats

Items	File Extension
Music	<ul style="list-style-type: none">• MP3(.mp3)• MP2(.mp2)• M4A(.m4a)• Lossless(.flac)• WAV(.wav)
Video	<ul style="list-style-type: none">• AVI(.avi)• MOV(.mov)• MPEG program stream (.mpg, .mp4)• 3GP(.3gp, 3g2)• ASF(.asf)• WMV(.wmv)• MKV(.mkv)• VOB(.vob)• DAT(.dat)• TS(.ts)• MPEG-4(.m4v)• FLV(.flv)
Photo	<ul style="list-style-type: none">• JPG/JPEG• BMP• PNG

Viewing files

1. Plug a USB flash drive into the **MEDIA READER** port of the projector.
2. Press **SOURCE** and select **Media Reader**. The projector displays the built in media reader main page.
3. Press **▲/▼** to select the file type and press **▶** to enter the local disk device.
4. Select the folder or a file you want to display and press **OK**.
5. After a file is displayed, press **OK** to call out the function bar. You can press **◀/▶** to select the function and press **OK** to enact the selected item.

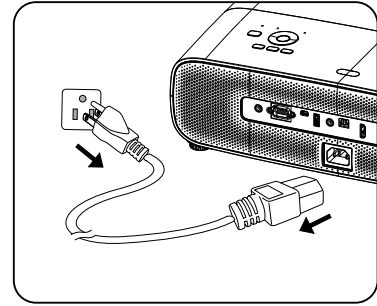

Shutting down the projector

1. Press  on the projector or  on the remote control and a confirmation message will appear prompting you. If you don't respond in a few seconds, the message will disappear.
2. Press  or  a second time. The power indicator flashes orange, the projection lamp shuts down, and the fans will continue to run for approximately 90 seconds to cool down the projector.
3. Once the cooling process finishes, the power indicator becomes a steady orange and fans stop. Disconnect the power cord from the power outlet.



- To protect the lamp, the projector will not respond to any commands during the cooling process.
- Avoid turning on the projector immediately after turning it off as excessive heat may shorten lamp life.
- Lamp life results will vary depending on environmental conditions and usage.

Direct power off

The AC power cord can be pulled out right after the projector is turned off. To protect the lamp, wait about 10 minutes before re-starting the projector. If you attempt to re-start the projector, the fans may run for a few minutes to cool down. In such cases, press  or  again to start the projector after the fans stop and the power indicator turns orange.

Menu operation

Please note that the on-screen display (OSD) menus vary according to the signal type selected and the projector model you are using.

The menu items are available when the projector detects at least one valid signal. If there is no equipment connected to the projector or no signal detected, limited menu items are accessible.

Basic menu

<p>Picture Mode</p>	<p>The projector is preset with several predefined picture modes so that you can choose one to suit your operating environment and input signal picture type.</p> <ul style="list-style-type: none"> • Bright: Maximizes the brightness of the projected image. This mode is suitable for environments where extra-high brightness is required, such as using the projector in well lit rooms. • Living Room: With well-saturated color, fine-tuned sharpness, and a higher brightness level, this mode is suitable for TV streaming in rooms where there is a small amount of ambient light, e.g. your living room. • Game: This mode is most suitable for playing video games. In game mode, the projector automatically optimizes the input lag to provide the fastest response time. In game mode, the image and sound are tuned for video games, allowing to have a perfect game-play experience in rooms with ambient light. Please note that some of the image adjustment functions will affect the input lag and are recommended to be turned off for the best gaming experience. • Sports: With well-saturated colors and higher brightness level, this mode is best for watching sporting events in a bright room. • Cinema: Complement with accurate color and deepest contrast at lower brightness level, Cinema mode is suitable for playing movies in a environment with a bit of ambient light, as if in a commercial cinema. • 3D: Is appropriate for playing 3D images and 3D video clips.  <ul style="list-style-type: none"> • This mode is only available when 3D function is enabled. • HDR10: Delivers High Dynamic Range effects with higher contrasts of brightness and colors for HDR Blu-ray movies. After auto-detecting metadata or EOTF info from HDR10 contents, HDR10 is available for selection. • HDR Game: When the projector detects HDR contents and Picture Mode is set to Game, it will automatically set to HDR Game. • HLG: Delivers Hybrid Long Gamma effects by adding a logarithmic curve with extra brightness over the top of the signal. This mode is only available when HLG is enabled. • User: Recalls the settings customized based on the current available picture modes. See User Management on page 26.
<p>Sound Mode</p>	<p>A variety of sound modes enables user to select and adjust the best mode that matches current environment.</p>

Light Source Mode	See Setting the Light Source Mode on page 36 .
2D Keystone	See Correcting keystone on page 15 .
Details Adjustment	Dynamic video contrast enhancement to adjust the brightness level of the video content automatically.
HDR Brightness	The projector can automatically adjust the brightness levels of your image according to the input source. You can also manually select a brightness level to display better picture quality. When the value is higher, the image becomes brighter; when the value is lower, the image becomes darker.
Information	<ul style="list-style-type: none"> • Detected Resolution: Shows the native resolution of the input signal. • Source: Shows the current signal source. • Picture Mode: Shows the selected mode in the Picture menu. • Light Source Mode: Shows the selected mode in the Light Source Information menu. • 3D Format: Shows the current 3D mode. • Color System: Shows the used light source mode. • Dynamic Range: Shows the picture dynamic range, e.g. SDR, HDR10, HLG, etc. • Light Source Usage Time: Shows the number of hours the light source has been used. • Firmware Version: Shows the firmware version of your projector. • Service Code: Shows the projector's serial number.
Menu Type	Switches to the Advanced OSD menu. See Advanced menu on page 26 .

Advanced menu

Picture

Picture Mode	See Picture Mode on page 24 .
Details Adjustment	See Details Adjustment on page 25 .
User Management	<p>• Load Settings From</p> <p>There is one user-definable mode if the current available picture modes are not suitable for your need. You can use one of the picture modes (except the User) as a starting point and customize the settings.</p> <ol style="list-style-type: none"> 1. Go to PICTURE > Picture Mode. 2. Press ◀/▶ to select User. 3. Press ▼ to highlight User Management and press OK. 4. Press ▼ to select Load Settings From and press OK. 5. Press ▼ to select a picture mode that is closest to your need. 6. Press ▼ to select the sub-menu items you want to change and adjust the values with ◀/▶. The adjustments define the selected user mode. <p>• Rename User Mode</p> <p>You can change User to the names easy to be identified or understood by the users of this projector. The new name can be up to 9 characters including English letters (A-Z, a-z), digits (0-9), and space (_).</p> <ol style="list-style-type: none"> 1. Go to PICTURE > Picture Mode > User. 2. Press ▼ to highlight User Management and press OK. 3. Press ▼ to select Rename User Mode and press OK. 4. Use ▲/▼/◀/▶, and OK to set desired characters. 5. When done, press BACK to save the changes and exit.
Brightness	The higher the value, the brighter the image. Adjust this control so the black areas of the image appear just as black and that detail in the dark areas is visible.
Contrast	The higher the value, the greater the contrast. Use this to set the peak white level after you have previously adjusted the Brightness setting to suit your selected input and viewing environment.
Color	Lower setting produces less saturated colors. If the setting is too high, colors on the image will be overpowering, which makes the image unrealistic.
Tint	The higher the value, the more greenish the picture becomes. The lower the value, the more reddish the picture becomes.
Sharpness	The higher the value, the sharper the picture becomes.
Brilliant Color	This feature utilizes a new color-processing and system level enhancements to enable higher brightness while providing truer, more vibrant colors in picture. It enables a greater than 50% brightness increase in mid-tone images, which are common in video and natural scenes, so the projector reproduces images in realistic and true colors.

Advanced Color Settings	<p>Gamma Selection</p> <p>Gamma refers to the relationship between input source and picture brightness. Choose a preferred gamma mode from among 1.8/2.0/2.1/2.2/2.3/2.4/2.5/2.6/BenQ.</p>
	<p>Color Temperature Tuning</p> <p>There are several preset color temperature settings available. The available settings may vary according to the signal type selected.</p> <ul style="list-style-type: none"> • Color Temperature Selects a color temperature from among Normal, Cool, Native, or Warm. You can also set a preferred color temperature by adjusting the following options. • Red Gain/Green Gain/Blue Gain Adjusts the contrast levels of Red, Green, and Blue. • Red Offset/Green Offset/Blue Offset Adjusts the brightness levels of Red, Green, and Blue. • Reset: All of the adjustments you've done for the Color Temperature Tuning menu return to the factory preset values.
	<p>Adv. Color Temperature Tuning</p> <p>Advanced color temperature is used for fine-tuning White Balance from bright part to dark part of the video by different brightness level which is divided into 11 points signal level (%). Users can adjust the intensity of Red/Green/Blue in the range of 0~200 for the color temperature of selected point at different brightness level.</p>

Advanced Color Settings

Color Management

This function provides seven sets (RGBCMY and **White Balance**) of colors to be adjusted. When you select each color, you can independently adjust its range and saturation according to your preference.

• Primary Color

Selects a color from among **R** (Red), **G** (Green), **B** (Blue), **C** (Cyan), **M** (Magenta), or **Y** (Yellow).

- **Hue:** Increase in the range will include colors consisted of more proportions of its two adjacent colors. Please refer to the illustration for how the colors relate to each other. For example, if you select Red and set its range at 0, only pure red in the projected picture will be selected. Increasing its range will include red close to yellow and red close to magenta.
- **Saturation:** Adjusts the values to your preference. Every adjustment made will reflect to the image immediately. For example, if you select Red and set its value at 0, only the saturation of pure red will be affected.

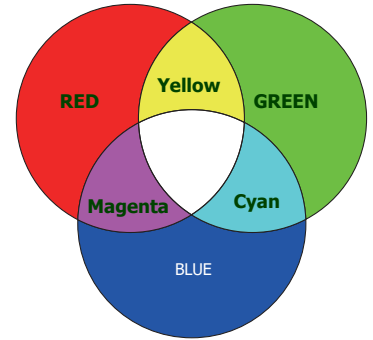

Saturation is the amount of that color in a video picture. Lower settings produce less saturated colors; a setting of “0” removes that color from the image entirely. If the saturation is too high, that color will be overpowering and unrealistic.

- **Gain:** Adjusts the values to your preference. The contrast level of the primary color you select will be affected. Every adjustment made will reflect to the image immediately.

• White Balance

Adjusts the color temperature of white.

- **R Gain/G Gain/B Gain:** Adjusts the contrast levels of Red, Green, and Blue.

• Reset

All of the adjustments you’ve done for the Color Management menu return to the factory preset values.

Advanced Color Settings	<p>CinemaMaster</p> <ul style="list-style-type: none"> • Color Enhancer <p>Allows you to fine-tune the saturation of colors with larger flexibility. It modulates complex color algorithms to flawlessly render saturated colors, fine gradients, intermediate hues and subtle pigments.</p> <ul style="list-style-type: none"> • Flesh Tone <p>Provides a smart adjustment of hue only for calibrating people's skin color, not other colors in the image. It prevents discoloration of skin tones from the light of the projection beam, portraying every skin tone in its most beautiful shade.</p> <ul style="list-style-type: none"> • Pixel Enhancer 4K <p>It is a super-resolution technology which radically enhances Full HD content in terms of colors, contrast, and textures. It's also a Detail Enhancement Technology refines surface details for true-to-life images that pop off the screen. Users can adjust levels of sharpness and detail enhancement for optimal viewing.</p> <ul style="list-style-type: none"> • Motion Enhancer 4K <p>You can use this feature to smooth fast-moving videos by comparing consecutive image frames and inserting an intermediate image frame between them.</p> <ul style="list-style-type: none"> • Local Contrast Enhancer <p>To divide video content into different "zones", it can dim the dark parts of the screen without affecting the bright areas. This makes the contrast look great for watching movies, especially in the dark.</p>
	<p>Dynamic Iris</p> <p>Changes the black level of the projected pictures to enhance the effect of contrast ratio.</p>
	<p>Light Source Mode</p> <p>See Setting the Light Source Mode on page 36.</p>
	<p>HDR Brightness</p> <p>The projector can automatically adjust the brightness levels of your image according to the input source. You can also manually select a brightness level to display better picture quality. When the value is higher, the image becomes brighter; when the value is lower, the image becomes darker.</p>
	<p>Noise Reduction</p> <p>Reduces electrical image noise. The higher the setting, the less the image noise.</p>
	<p>Reset Current Picture Mode</p> <p>Returns all of the adjustments you've made for the selected Picture Mode to the factory preset values.</p>

Audio



Sound Mode	A variety of sound modes enables user to select and adjust the best mode that matches current environment.
User Sound EQ	Select desired frequency bands (100 Hz, 300 Hz, 1k Hz, 4k Hz, and 10k Hz) to adjust the levels according to your preference. The settings made here define the User mode.
Audio Output	Selects audio output from internal or external speakers. <ul style="list-style-type: none"> • treVolo: Audio output to internal speakers. • S/PDIF: Audio output to external speaker via S/PDIF and mute internal speakers. • Audio Return+: Turns on Audio Return(+) function and changes audio output from internal speakers to ARC/eARC soundbar via HDMI-2. • 3.5mm Jack: Audio out to external speaker via 3.5mm Jack and mute internal speakers.
Audio Output Format	Selects audio format (LPCM, RAW, RAW+) from source device connected to HDMI-1 / HDMI-3 and pass them to external device via S/PDIF or ARC/eARC (HDMI-2) of projector.
Mute	Temporarily turns off the sound.
Volume	Adjusts the sound level.
L/R Switch	Switch the left/right audio channels.
Power On/Off Ring Tone	Turns on or off the ring tone when the projector is in startup and shutdown process.
Reset Audio	All of the adjustments you've done for the Audio menu return to the factory preset values.

Display

<p>Aspect Ratio</p>	<p>There are several options to set the image's aspect ratio depending on your input signal source.</p> <ul style="list-style-type: none"> • Auto: Scales an image proportionally to fit the projector's native resolution in its horizontal or vertical width. • 4:3: Scales an image so that it is displayed in the center of the screen with a 4:3 aspect ratio. • 16:9: Scales an image so that it is displayed in the center of the screen with a 16:9 aspect ratio. • 2.4:1: Scales an image so that it is displayed in the center of the screen with a 2.4:1 aspect ratio.
<p>Auto Source Search</p>	<p>Allows the projector to automatically search for a signal.</p>
<p>Source Rename</p>	<p>Renames the current input source to your desired name.</p> <p>On the Source Rename page, use ▲/▼/◀/▶, and OK to set the desired characters for the connected source item.</p> <p>When done, press BACK to save the changes and exit.</p>
<p>3D</p>	<p>This projector features a 3D function which enables you to enjoy the 3D movies, videos, and sporting events in a more realistic way by presenting the depth of the images. You need to wear a pair of 3D glasses to view the 3D images.</p> <ul style="list-style-type: none"> • 3D Mode: The default setting is Auto and the projector automatically chooses an appropriate 3D format when detecting 3D contents. If the projector cannot recognize the 3D format, manually choose a 3D mode according to your preference. • 3D Sync Invert When your 3D image is distorted, enable this function to switch between the image for the left eye and the right eye for more comfortable 3D viewing experience

<p>HDMI Settings</p>	<ul style="list-style-type: none"> • HDMI Format Selects a suitable RGB color range to correct the color accuracy. <ul style="list-style-type: none"> • Auto: Automatically selects a suitable color space and gray level for the incoming HDMI signal. • Limited: Utilizes the Limited range RGB 16-235. • Full: Utilizes the Full range RGB 0-255. • HDMI Equalizer Sets a suitable value to maintain the HDMI picture quality in long distance data transmission. • HDMI EDID Switch HDMI EDID between HDMI 1.4, HDMI 2.0 or HDMI 2.1 in order to solve compatibility issue with certain old players. <ul style="list-style-type: none"> • Enhanced: Enhanced mode can switch to HDMI 2.0 EDID (support 4K 60Hz HDR/HDR+) • Standard: Standard mode can switch to HDMI 1.4 EDID. Use this mode when you experience abnormal display issue with uncertain old players. HDMI 1.4 EDID can support up to 1080p 60Hz. • HDMI Device Control When you enable this function and connect an HDMI CEC-compatible device to your projector with an HDMI cable, turning on the HDMI CEC compatible device automatically turns on the projector, while turning off the projector automatically turns off the HDMI CEC compatible device. • HDMI Power On/Off Link When you connect an HDMI CEC-compatible device to your projector with an HDMI cable, you can set the behavior of powering on/off between the device and the projector.
<p>24P Real Cinema</p>	<ul style="list-style-type: none"> • On: The projector will output 48Hz, 50Hz, 60Hz, 100Hz, 120Hz, 240Hz depending on different input timing. • Off: The projector will only output 60Hz.
<p>Reset Display</p>	<p>Returns all the settings on the Display menu to the factory default values.</p>

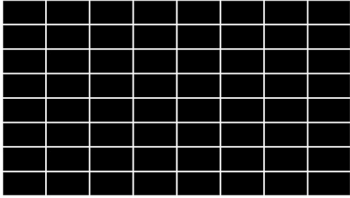
Installation

Projector Position	The projector can be installed on a ceiling or behind a screen, or with one or more mirrors. See Choosing a location on page 11 .
2D Keystone	See Correcting keystone on page 15 for details.
Test Pattern	<p>Adjusts the image size and focus and check that the projected image is free from distortion.</p> 
High Altitude Mode	<p>We recommend you use the High Altitude Mode when your environment is between 1500 m –3000 m above sea level, and ambient temperature is between 0°C–30°C.</p> <p>Operation under "High Altitude Mode" may cause a higher decibel operating noise level because of increased fan speed necessary to improve overall system cooling and performance.</p> <p>If you use this projector under other extreme conditions excluding the above, it may display auto shut-down symptoms, which is designed to protect your projector from over-heating. In cases like this, you should switch to High Altitude mode to solve these symptoms. However, this is not to state that this projector can operate under any and all harsh or extreme conditions.</p>  <ul style="list-style-type: none"> • Do not use the High Altitude Mode if your altitude is between 0 m and 1500 m and ambient temperature is between 0°C and 35°C. The projector will be over cooled, if you turn the mode on under such a condition.
12V Trigger	<p>There are two 12V triggers that work independently according to your needs for installation scenarios.</p> <ul style="list-style-type: none"> • On: If this is selected, the projector will send electronic signal out when it is turned on. • Off: If this is selected, the projector will not send electronic signal out when it is turned on.
Baud Rate	Select a baud rate that is identical with your computer's so that you can connect the projector with a suitable RS-232 cable and update or download the projector's firmware. This function is intended for qualified service personnel.

System

Language	Sets the language for the On-Screen Display (OSD) menus.
Background Settings	<ul style="list-style-type: none"> • Splash Screen Allows you to select which logo screen will be displayed during projector start-up.
Menu Settings	<ul style="list-style-type: none"> • Menu Type Selects OSD menu type. <ul style="list-style-type: none"> • Menu Display Time Sets the length of time the OSD will remain active after your last key press. <ul style="list-style-type: none"> • Menu Position Sets the On-Screen Display (OSD) menu position.
Light Source Information	Shows light hour of used time or resets light source timer. See Lamp information on page 35 .
Operation Settings	<ul style="list-style-type: none"> • Reminder message Sets the reminder messages on or off. <ul style="list-style-type: none"> • LED Indicator You can turn off the LED warning lights. This is to avoid any light disturbance when viewing images in a dark room. <ul style="list-style-type: none"> • Power On/Off Settings <ul style="list-style-type: none"> • Direct Power On: Allows the projector to turn on automatically once the power is fed through the power cord. • Auto Power Off: Allows the projector to turn off automatically if no input signal is detected after a set period of time to prevent unnecessary waste of lamp life. • BenQ HDMI Media Streaming (QS02) To enable or disable functions related to Android TV dongle (QS02).
Firmware Upgrade	Updates the projector firmware via USB reader.
Factory Default	Returns all settings to the factory preset values.  <p>The following settings will still remain: 2D Keystone, Projector Position, Light Source Information, Baud Rate, High Altitude Mode.</p>
Reset System	Returns all the settings on the System menu to the factory default values.

Information

Information	See Information on page 25 .
--------------------	--

Maintenance

Care of the projector

Cleaning the lens

Clean the lens whenever you notice dirt or dust on the surface. Please be sure to turn off the projector and let it cool down completely before cleaning the lens.

- Use a canister of compressed air to remove dust.
- If there is dirt or smears, use lens-cleaning paper or moisten a soft cloth with lens cleaner and gently wipe the lens surface.
- Never use any type of abrasive pad, alkaline/acid cleaner, scouring powder, or volatile solvent, such as alcohol, benzene, thinner or insecticide. Using such materials or maintaining prolonged contact with rubber or vinyl materials may result in damage to the projector surface and cabinet material.

Cleaning the projector case

Before you clean the case, turn the projector off using the proper shutdown procedure as described in [Shutting down the projector on page 23](#) and unplug the power cord.

- To remove dirt or dust, wipe the case with a soft, lint-free cloth.
- To remove stubborn dirt or stains, moisten a soft cloth with water and a neutral pH detergent. Then wipe the case.



Never use wax, alcohol, benzene, thinner or other chemical detergents. These can damage the case.

Storing the projector

If you need to store the projector for an extended time, please follow the instructions below:

- Make sure the temperature and humidity of the storage area are within the recommended range for the projector. Please refer to [Specifications on page 43](#) or consult your dealer about the range.
- Retract the adjuster feet.
- Remove the battery from the remote control.
- Pack the projector in its original packing or equivalent.

Transporting the projector

It is recommended that you ship the projector with its original packing or equivalent.

Lamp information

Getting to know the lamp hour

When the projector is in operation, the duration (in hours) of lamp usage is automatically calculated by the built-in timer. The method of calculating the equivalent lamp hour is as follows:

1. **Light Source Usage Time** = $(x+y+z)$ hours, if
Time used in Normal mode = x hours
Time used in Eco mode = y hours
Time used in SmartEco mode = z hours

2. Equivalent Light Hours = α hours

$$\alpha = \frac{A'}{X} \times X + \frac{A'}{Y} \times Y + \frac{A'}{Z} \times Z, \text{ if}$$

X = lamp life spec of Normal mode

Y = lamp life spec of Eco mode

Z = lamp life spec of SmartEco mode

A' is the longest lamp life spec among X, Y, Z



For Time used in each lamp mode shown in OSD menu:

- Time used is accumulated and rounded down to an integer in Hours.

- When time used is less than 1 hour, it shows 0 hours.

When you calculate Equivalent Lamp hour manually, it will probably have deviation from the value shown in OSD menu since projector system calculates Time used for each lamp mode in "Minutes" then rounds down to an integer in hours shown in OSD.

To obtain the lamp hour information:

Go to **Advanced** menu - **System** > **Light Source Information** and press **OK**. The **Light Source Information** page appears.

You can also get the lamp hour information on the **Information** menu.

Extending light source life

• Setting the **Light Source Mode**

Go to **Advanced** Menu - **Picture** > **Advanced Color Settings** > **Light Source Mode**, press **OK**. The **Light Source Mode** page appears.

Setting the projector in **ECO** or **SmartEco** mode extends lamp life.

Lamp mode	Description
Normal	Provides full lamp brightness
ECO	Lowers brightness to extend the lamp life and decreases the fan noise
SmartEco	Adjusts the lamp power automatically depending on the content brightness level while optimizing display quality

• Setting **Auto Power Off**

This function allows the projector to turn off automatically if no input signal is detected after a set period of time to prevent unnecessary waste of lamp life.

To set **Auto Power Off**, go to **Advanced** menu - **System** > **Operation Settings** > **Power On/Off Settings** > **Auto Power Off** and press ◀/▶.





Timing of replacing the lamp

When the **Lamp indicator** lights up or a message appears suggesting it is time to replace the lamp, please consult your dealer or go to <http://www.BenQ.com> before installing a new lamp. An old lamp may cause a malfunction in the projector and in some instances the lamp may explode.

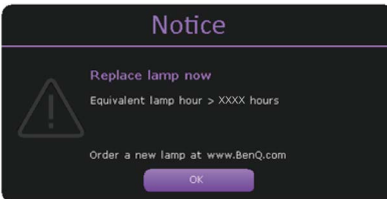

- The apparent brightness of the projected image will vary depending on the ambient lighting conditions, selected input signal contrast/brightness settings, and is directly proportional to projection distance.
- The lamp brightness will decline over time and may vary within the lamp manufacturers specifications. This is normal and expected behavior.
- The **LAMP indicator light** and **TEMPerature warning light** will light up if the lamp becomes too hot. Turn the power off and let the projector cool for 45 minutes. If the Lamp or Temp indicator still lights up after turning the power back on, please contact your dealer. See [Indicators on page 41](#).

The following Lamp warning displays will remind you to change the lamp.

 <p>Notice</p> <p>Order a replacement lamp Equivalent lamp hour > XXXX hours</p> <p>Order a new lamp at www.BenQ.com</p> <p>OK</p>	<p>Install a new lamp for optimal performance. Press OK to dismiss the message.</p>
 <p>Notice</p> <p>Replace lamp soon Equivalent lamp hour > XXXX hours</p> <p>Order a new lamp at www.BenQ.com</p> <p>OK</p>	<p>It is strongly recommended that you replace the lamp at this age. The lamp is a consumable item. The lamp brightness diminishes with use. This is normal lamp behavior. You can replace the lamp whenever you notice that the brightness level has significantly diminished.</p> <p>Press OK to dismiss the message.</p>
  <p>Notice</p> <p>Replace lamp now Equivalent lamp hour > XXXX hours</p> <p>Order a new lamp at www.BenQ.com</p> <p>OK</p> <p>Notice</p> <p>Out of lamp usage time Replace lamp (refer to user manual) Then reset the lamp timer</p> <p>Order a new lamp at www.BenQ.com</p> <p>OK</p>	<p>The lamp MUST be replaced before the projector will operate normally.</p> <p>Press OK to dismiss the message.</p>



"XXXX" shown in the above messages are numbers that vary depending on different models.

Replacing the lamp (FOR SERVICE PERSONNEL ONLY)

Please consult your dealer or go to <http://www.BenQ.com> before installing a new lamp. An old lamp may cause a malfunction in the projector and in some instances the light may explode. Please seek support from a qualified service technician to replace the lamp of your projector. Please unplug the power cable of the BenQ projector and wait for 10 minutes to ensure power-off progress completely to avoid electric shock. Please also refer to the product user manual for safety instructions to ensure a safe lamp replacement.



- To reduce the risk of electrical shock, always turn the projector off and disconnect the power cord before changing the lamp.



- This illustration on the top of the lamp module indicates the lamp module is high temperature and may burn your fingers. We suggest to seek support from a qualified service technician to replace the lamp. And allow the projector to cool for at least 45 minutes before replacing the lamp.

- To reduce the risk of injuries to fingers and damage to internal components, use caution when removing lamp glass that has shattered into sharp pieces.
 - To reduce the risk of injuries to fingers and/or compromising image quality by touching the lens, do not touch the empty lamp compartment when the lamp is removed.
 - This lamp contains mercury. Consult your local hazardous waste regulations to dispose of this lamp in a proper manner.
 - To assure optimal performance from the projector, it is recommended that you purchase a qualified projector lamp for lamp replacement.
 - If lamp replacement is performed while the projector is suspended upside-down, make sure that no one is underneath the lamp socket to avoid any possible injury or damage to the human eyes caused by fractured lamp.
 - Ensure good ventilation when handling broken lamps. We recommend that you use respirators, safety glasses, goggles or face shield and wear protective clothing such as gloves.
1. Turn the power off and disconnect the projector from the power outlet. If the lamp is hot, avoid burns by waiting for approximately 45 minutes until the lamp has cooled.
 2. Loosen the screw(s) that secure the lamp cover on the side of the projector until the lamp cover loosens.

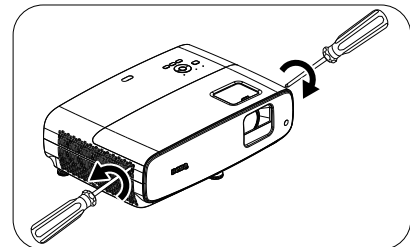

3. Remove the lamp cover from the projector.



- Do not turn the power on with the lamp cover open.
- Do not insert your fingers between the lamp and the projector. The sharp edges inside the projector may cause injuries

4. Remove the safety mylar.
5. Disconnect the lamp connector.

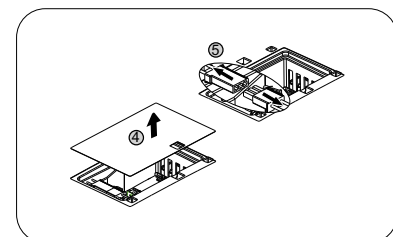
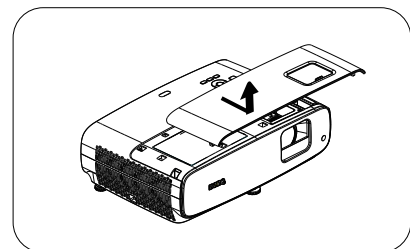

6. Loosen the screw(s) that secure the inner lamp.
7. Lift the handle so that it stands up.

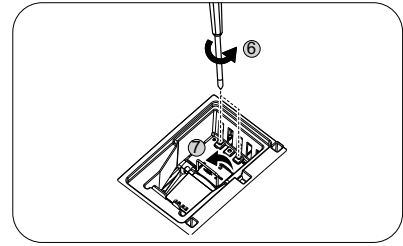

8. Use the handle to slowly pull the lamp out of the projector.



- Pulling it too quickly may cause the lamp to break and scatter broken glass in the projector.
- Do not place the lamp in locations where water might splash on it, children can reach it, or near flammable materials.
- Do not insert your hands into the projector after the lamp is removed. The sharp edges inside the projector may cause injuries. If you touch the optical components inside, it could cause color unevenness and distortion of the projected images.

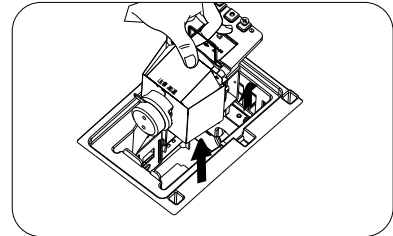

9. Insert the lamp connector.

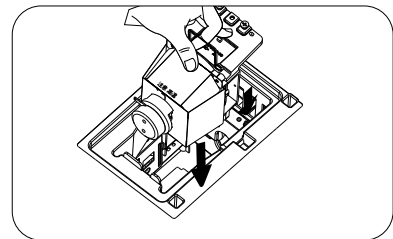

10. Tighten the screw(s) that secures the lamp.

11. Ensure the handle is fully laid flat and locked in place.



- Loose screw may cause a bad connection, which could result in malfunction.
- Do not over tighten the screw.

12. Connect the lamp connector.

13. Put the safety mylar back to the top.

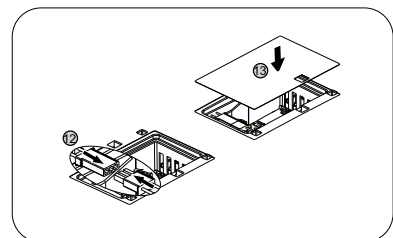
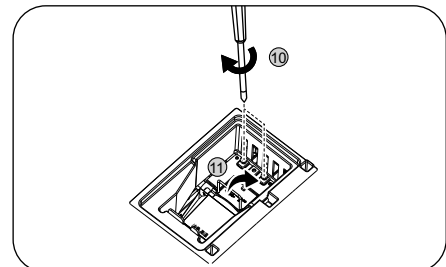

14. Replace the lamp cover on the projector.

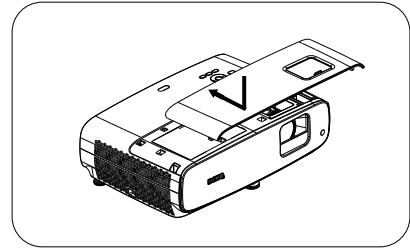

15. Tighten the screw that secures the lamp cover.



- Loose screw may cause a bad connection, which could result in malfunction.
- Do not over tighten the screw.

16. .Connect the power and restart the projector.

Resetting the lamp timer

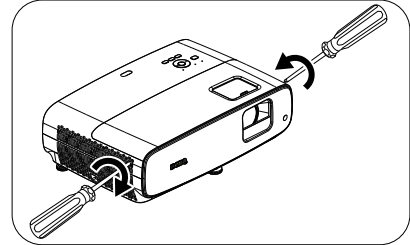



















































17. After the startup logo, open the On-Screen Display









(OSD) menu. Go to **Advanced** menu - **System** > **Light Source Information** and press **OK**. The **Light Source Information** page appears. Highlight **Reset Light Timer** and press **OK**. A warning message is displayed asking if you want to reset the lamp timer. Highlight **Reset** and press **OK**. The lamp time will be reset to “0”.



- Do not reset if the lamp is not new or replaced as this could cause damage.

Indicators

Light			Status & Description
POWER ○	TEMP ○	LAMP ○	
System events			
			System is in stand-by mode
			System is powering up
			System is under normal operation
			System is cooling down
			Downloading
			Colorwheel start fail
			Scaler reset fail
			Lamp life exhausted
Burn-In events			
			Burn-in on
			Burn-in off
Lamp events			
			Lamp error in normal operation
			Lamp is not lit up
Thermal events			
			Fan 1 error (the actual fan speed is outside the desired speed)
			Fan 2 error (the actual fan speed is outside the desired speed)
			Fan 3 error (the actual fan speed is outside the desired speed)
			Fan 4 error (the actual fan speed is outside the desired speed)
			Temperature 1 error (over limited temperature)

	 : Off	 : Orange On	 : Green On	 : Red On
		 : Orange Flashing	 : Green Flashing	 : Red Flashing

Troubleshooting

? The projector does not turn on.

Cause	Remedy
There is no power from the power cord.	Plug the power cord into the AC power jack on the projector, and plug the power cord into the power outlet. If the power outlet has a switch, make sure that it is switched on.
Attempting to turn the projector on again during the cooling process.	Wait until the cooling down process has completed.

? No picture

Cause	Remedy
The video source is not turned on or connected correctly.	Turn the video source on and check that the signal cable is connected correctly.
The projector is not correctly connected to the input signal device.	Check the connection.
The input signal has not been correctly selected.	Select the correct input signal with the SOURCE key.
The lens cover is still closed.	Open the lens cover.

? Blurred image

Cause	Remedy
The projection lens is not correctly focused.	Adjust the focus of the lens using the focus ring.
The projector and the screen are not aligned properly.	Adjust the projection angle and direction as well as the height of the projector if necessary.
The lens cover is still closed.	Open the lens cover.

? Remote control does not work.

Cause	Remedy
The batteries are out of power.	Replace both of the batteries with new ones.
There is an obstacle between the remote control and the projector.	Remove the obstacle.
You are too far away from the projector.	Stand within 8 meters (26 feet) of the projector.

? The password is incorrect.

Cause	Remedy
You do not remember the password.	See Entering the password recall procedure on page 21 .

Specifications

Projector specifications



All specifications are subject to change without notice.

Optical

Resolution

3840 x 2160 with XPR
1920 x 1080 without XPR

Display system

1-CHIP DMD

Lens

F = 1.84 ~ 2, f = 12 ~ 15.6 mm

Clear focus range

1.2m ~ 5.1m @ Wide,
1.3m ~ 4.9m @ Tele

Light source

240W±3% @ Normal Mode

Zoom ratio

1.3x ±2%

Electrical

Power supply

AC100–240V, 3.40 A, 50/60 Hz (Automatic)

Power consumption

Max.: 350 W; Standby: 0.5W Max. at 100 ~ 240VAC

Mechanical

Weight

4.2 Kg ± 200 g (9.3 lbs ± 0.44 lbs)

Output terminals

Speaker

5 watt x 2

Audio signal output

PC audio jack x 1
SPDIF to optical x 1

Control

USB

Type-A x 1: Media reader/drive, Firmware download (1.5A)
Type-A x 1: Power supply (2.5A)
Mini-B x 1

12V DC x 1: Trigger for screen control

RS-232 serial control

9 pin x 1

IR receiver x 2

Input terminals

Video signal input

HDMI (HDCP 2.2) x 3

Environmental Requirements

Operating temperature

0°C–40°C at sea level

Operating relative humidity

10%–90% (without condensation)

Operating altitude

0–1499 m at 0°C–35°C

1500–3000 m at 0°C–30°C (with

High Altitude Mode on)

Storage temperature

-20°C–60°C at sea level

Storage humidity

10%–90% RH (without condensation)

Storage altitude

30°C@ 0~12,200m above sea level

Transporting

Original packing or equivalent is recommended

Repairing

Please visit below website and choose your country to find your service contact window.

<http://www.benq.com/welcome>

Dimensions

380 mm (W) x 127 mm (H) x 263 mm (D)

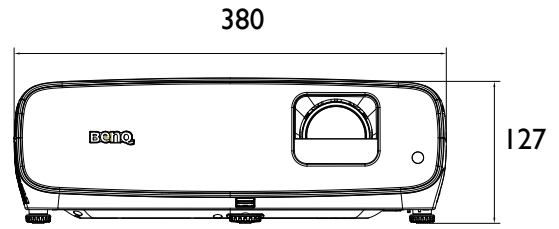
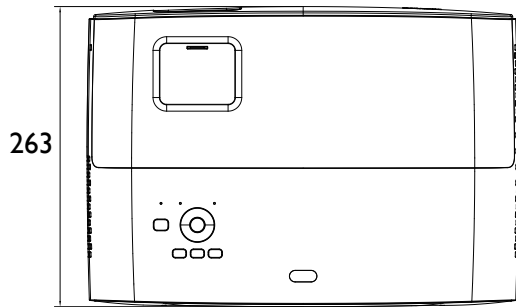

Unit: mm

Timing chart

Supported timing for HDMI (HDCP) input

- PC timings

Resolution	Mode	Vertical Frequency (Hz)	Horizontal Frequency (kHz)	Pixel Frequency (MHz)	Supported 3D format		
					Field Sequential	Top Bottom	Side by Side
640 x 480	VGA_60	59.940	31.469	25.175	V	V	V
	VGA_72	72.809	37.861	31.500			
	VGA_75	75.000	37.500	31.500			
	VGA_85	85.008	43.269	36.000			
720 x 400	720 x 400_70	70.087	31.469	28.3221			
800 x 600	SVGA_60	60.317	37.879	40.000	V	V	V
	SVGA_72	72.188	48.077	50.000			
	SVGA_75	75.000	46.875	49.500			
	SVGA_85	85.061	53.674	56.250			
	SVGA_120 (Reduce Blanking)	119.854	77.425	83.000	V		
1024 x 768	XGA_60	60.004	48.363	65.000	V	V	V
	XGA_70	70.069	56.476	75.000			
	XGA_75	75.029	60.023	78.750			
	XGA_85	84.997	68.667	94.500			
	XGA_120 (Reduce Blanking)	119.989	97.551	115.5	V		
1152 x 864	1152 x 864_75	75	67.5	108			
1024 x 576@60Hz	BenQ Notebook Timing	60.00	35.820	46.996			
1024 x 600@65Hz	BenQ Notebook Timing	64.995	41.467	51.419			
1280 x 720	1280 x 720_60	60	45.000	74.250	V	▲	▲
1280 x 768	1280 x 768_60	59.870	47.776	79.5	V	V	V
1280 x 800	WXGA_60	59.810	49.702	83.500	V	V	V
	WXGA_75	74.934	62.795	106.500			
	WXGA_85	84.880	71.554	122.500			
	WXGA_120 (Reduce Blanking)	119.909	101.563	146.25	V		
1280 x 1024	SXGA_60	60.020	63.981	108.000		V	V
	SXGA_75	75.025	79.976	135.000			
	SXGA_85	85.024	91.146	157.500			
1280 x 960	1280 x 960_60	60.000	60.000	108		V	V
	1280 x 960_85	85.002	85.938	148.500			
1360 x 768	1360 x 768_60	60.015	47.712	85.500		V	V
1440 x 900	WXGA+_60	59.887	55.935	106.500		V	V
1400 x 1050	SXGA+_60	59.978	65.317	121.750		V	V
1600 x 1200	UXGA	60.000	75.000	162.000		V	
1680 x 1050	1680 x 1050_60	59.954	65.290	146.250		V	V
640 x 480@67Hz	MAC13	66.667	35.000	30.240			
832 x 624@75Hz	MAC16	74.546	49.722	57.280			
1024 x 768@75Hz	MAC19	75.020	60.241	80.000			
1152 x 870@75Hz	MAC21	75.06	68.68	100.00			
1920 x 1080@60Hz	1920 x 1080_60 (CEA-861)	60	67.5	148.5	V	▲	▲
1920 x 1200@60Hz	1920 x 1200_60 (Reduce Blanking)	59.95	74.038	154	V	V	V
1920x1080@120 HZ	1920X1080_120	120.000	135.000	297	V		

1920x1200@120 HZ	1920X1200_120 (Reduce Blanking)	119.909	152.404	317.00	V		
3840 x 2160	3840 x 2160_30 For 4K2K model	30	67.5	297			
3840 x 2160	3840 x 2160_60 For 4K2K model (Only HDMI 2.0 support)	60	135	594			



• ▲: support auto-detect 3D and manually set 3D format. If source can output CEA861 720p/1080p and color space is RGB with 3D inframe then 3D auto detect function is also workable.

• V: support manually set 3D format

• Video timings

Timing	Resolution	Horizontal Frequency (kHz)	Vertical Frequency (Hz)	Dot Clock Frequency (MHz)	Supported 3D format			
					Field Sequential	Frame Packing	Top Bottom	Side by Side
480i	720 (1440) x 480	15.73	59.94	27	V			
480p	720 x 480	31.47	59.94	27	V			
576i	720 (1440) x 576	15.63	50	27				
576p	720 x 576	31.25	50	27				
720/50p	1280 x 720	37.5	50	74.25		▲	▲	▲
720/60p	1280 x 720	45.00	60	74.25	V	▲	▲	▲
1080/24P	1920 x 1080	27	24	74.25		▲	▲	▲
1080/25P	1920 x 1080	28.13	25	74.25				
1080/30P	1920 x 1080	33.75	30	74.25				
1080/50i	1920 x 1080	28.13	50	74.25				▲
1080/60i	1920 x 1080	33.75	60	74.25				▲
1080/50P	1920 x 1080	56.25	50	148.5			▲	▲
1080/60P	1920 x 1080	67.5	60	148.5	V		▲	▲
1080/120p	1920 x1080	135	120	297	V			
2160/24P	3840 x 2160 (Only HDMI 2.0 support)	54	24	297				
2160/25P	3840 x 2160 (Only HDMI 2.0 support)	56.25	25	297				
2160/30P	3840 x 2160 (Only HDMI 2.0 support)	67.5	30	297				
2160/50P	3840 x 2160 (Only HDMI 2.0 support)	112.5	50	594				
2160/60P	3840 x 2160 (Only HDMI 2.0 support)	135	60	594				



• ▲: support auto detect 3D and manually set 3D format

• V: support manually set 3D format

Color Depth Table

Display format (refresh rate)	Chroma subsampling	8 Bit	10 Bit	12 Bit
4K/60p (60 Hz)	4:4:4	V		
	4:2:2	V	V	
	4:2:0	V	V	V
4K/60p (50 Hz)	4:4:4	V		
	4:2:2	V	V	
	4:2:0	V	V	V
4K/30p (30 Hz)	4:4:4	V	V	V
	4:2:2	V	V	V
	4:2:0	V	V	V
4K/24p (24 Hz)	4:4:4	V	V	V
	4:2:2	V	V	V
	4:2:0	V	V	V

1080P/60P (60 Hz)	4:4:4	√	√	√
	4:2:2	√	√	√
	4:2:0	√	√	√
1080P/50P (50 Hz)	4:4:4	√	√	√
	4:2:2	√	√	√
	4:2:0	√	√	√
1080P/30P (30 Hz)	4:4:4	√	√	√
	4:2:2	√	√	√
	4:2:0	√	√	√
1080P/24P (24 Hz)	4:4:4	√	√	√
	4:2:2	√	√	√
	4:2:0	√	√	√