

EN

DE

ES

FR

IT

NL

PT

AR

imou

Quick Start Guide

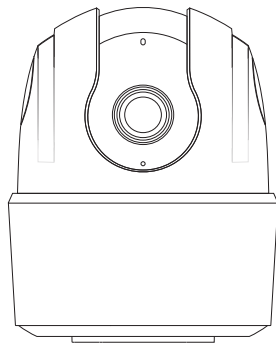

www.imoulife.com

Welcome

Thank you for choosing Imou.

We are devoted to providing you easy smart home products. If you have problems using the product, please contact our service team before returning your product.

Our service mail: service.global@imoulife.com.

Detailed installation instructions & videos, frequently asked questions can be found at: imoulife.com/support/help or scan this QR code to help page.

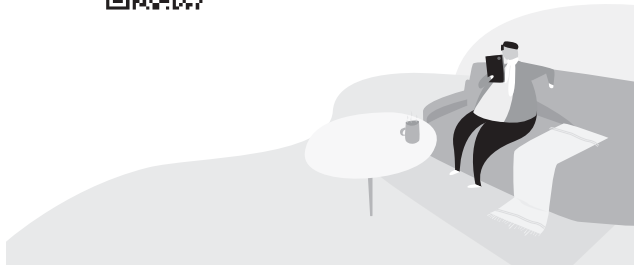

Package Content



Camera ×1



Power Cable ×1



Power Adapter ×1



Positioning Map ×1



Quick Start Guide ×1



Screw Package ×1



Mounting Plate ×1

Camera Introduction

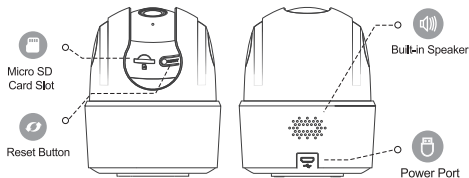
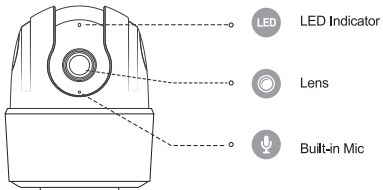

Note: Press and hold the reset button for 10 s to reset the camera.

The description of the LED indicator is included in the following table.

LED Status	Device Status
Off	<ul style="list-style-type: none"> Powered off/LED turned off Rebooting after reset
Red light on	<ul style="list-style-type: none"> Booting Device malfunction
Green light flashing	<ul style="list-style-type: none"> Waiting for network
Green light on	<ul style="list-style-type: none"> Operating properly
Red light flashing	<ul style="list-style-type: none"> Network connection failed
Green and red light flashing alternately	<ul style="list-style-type: none"> Firmware updating

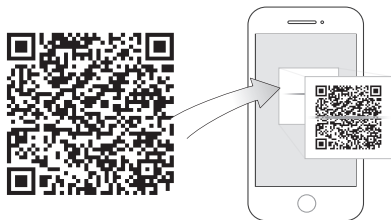

i Tips

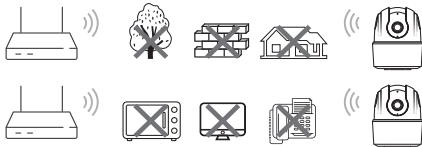

To ensure the best possible wireless performance, please make sure that there are no obstacles and electromagnetic interference between the camera and router.

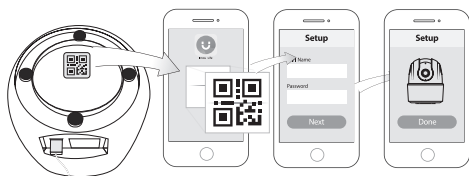

Ceiling Mounting (Optional)

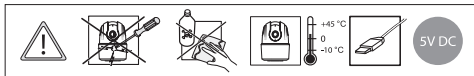
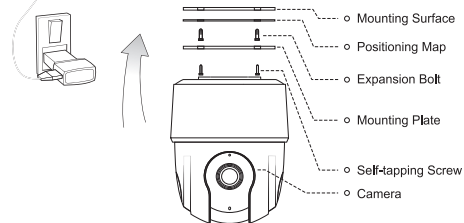

Troubleshooting

Problem	Solution
Cannot configure the camera	<ul style="list-style-type: none"> • Make sure that your smart phone and the camera are within range of your Wi-Fi router. • Make sure that the LED indicator on the camera is flashing green.
How to find the camera Wi-Fi password	It is the safety code on the device label.
No picture or device is offline	<ul style="list-style-type: none"> • Make sure that the LED indicator on the camera is flashing green. See "LED Status" section for details if otherwise. • Make sure that the camera is properly connected to power using the included USB power adapter. • Reposition the camera, router, or both to improve signal strength.
Picture is not clear	<ul style="list-style-type: none"> • Check the camera lens for dirt, dust, and spider webs. Clean the lens with a soft, clean cloth. • Remove the vinyl cover on the camera lens.
No audio	<ul style="list-style-type: none"> • Make sure that audio function on camera is turned on. • Make sure that audio is turned up on viewing device.
Human detection does not work	Make sure that you have enabled Human Detection in the Device Settings interface of Imou Life App.
Camera stuck downwards	Check Privacy Mode setting on Imou Life App.
Fail to scan QR code	<ul style="list-style-type: none"> • Clean the camera lens of your smart phone. • Make sure that there is enough light on the QR code. • Do not hold the QR code too close to the camera.

imou

Kurzanleitung

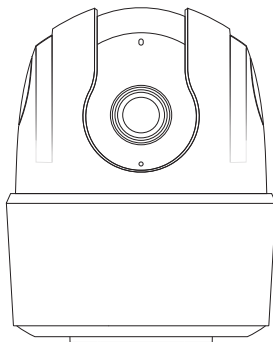

www.imoulife.com

Willkommen

Vielen Dank, dass Sie sich für Imou entschieden haben. Wir sind bestrebt, Ihnen einfache Smart-Home-Produkte anzubieten. Wenn Sie Probleme bei der Verwendung des Produkts haben, wenden Sie sich bitte an unser Serviceteam, bevor Sie Ihr Produkt zurückschicken.

Unsere Service-Mail lautet: service.global@imoulife.com.

Detaillierte Installationsanleitungen und Videos sowie häufig gestellte Fragen finden Sie unter: imoulife.com/support/help oder scannen Sie diesen QR-Code, um die Hilfeseite aufzurufen.



Packungsinhalt



1 x Kamera



1 x Stromkabel



1 x Netzteil



1 x Positionierungskarte



1 x Kurzanleitung



1 x Schraubenbeutel



1 x Montageplatte

Kamera Einführung

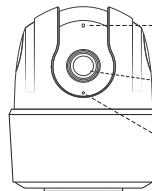

-  LED-Anzeige
-  Objektiv
-  Integriertes Mikrofon

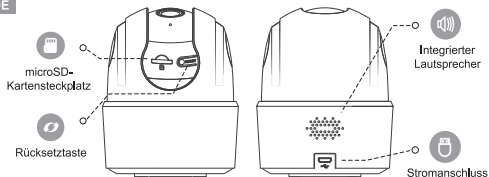

Hinweis: Halten Sie die Rücksetztaste für 10 Sekunden gedrückt, um die Kamera zurückzusetzen.

Die Beschreibung der LED-Anzeige ist in der nachstehenden Tabelle enthalten.

LED-Status	Gerätestatus
Aus	<ul style="list-style-type: none"> Gerät/LED ausgeschaltet Neustart nach dem Zurücksetzen
Rote LED leuchtet	<ul style="list-style-type: none"> Gerät fährt hoch Gerätestörung
Grüne LED blinkt	<ul style="list-style-type: none"> Warten auf Netzwerkverbindung
Grüne LED leuchtet	<ul style="list-style-type: none"> Ordnungsgemäß funktionieren
Rote LED blinkt	<ul style="list-style-type: none"> Netzwerkverbindung fehlgeschlagen
Grüne und rote LED blinken abwechselnd	<ul style="list-style-type: none"> Firmware-Update

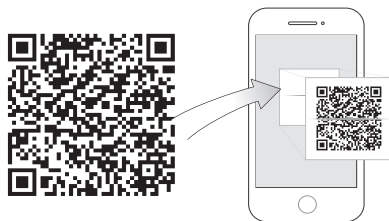

i Tipps

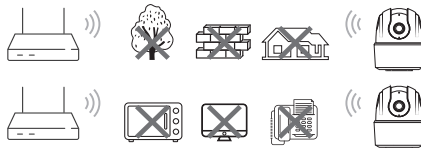

Um die bestmögliche Funkübertragung zu gewährleisten, stellen Sie sicher, dass zwischen Kamera und Router keine Hindernisse und elektromagnetische Störungen vorhanden sind.

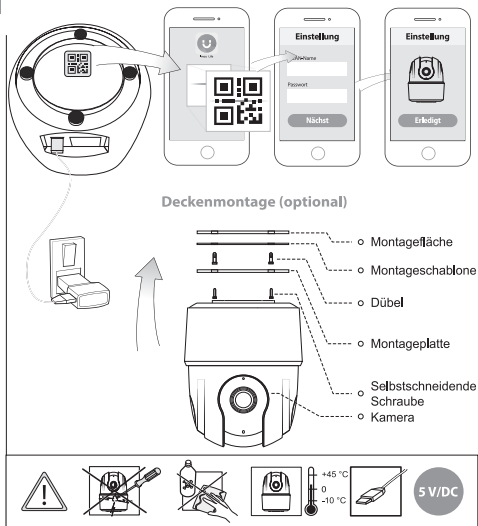

Störungsbehebung

Problem	Lösung
Die Kamera kann nicht konfiguriert werden	<ul style="list-style-type: none"> • Stellen Sie sicher, dass sich Ihr Smartphone und die Kamera in Reichweite Ihres WLAN-Routers befinden. • Stellen Sie sicher, dass die LED-Anzeige an der Kamera grün blinkt.
Wie die Kamera Wifi Passwort finden kann	Es ist der Sicherheitscode auf dem Geräteetikett.
Kein Bild oder Gerät ist offline	<ul style="list-style-type: none"> • Stellen Sie sicher, dass die LED-Anzeige an der Kamera grün blinkt. Siehe „LED-Status“ für weitere Informationen. • Stellen Sie sicher, dass die Kamera mit dem mitgelieferten USB-Netzteil ordnungsgemäß an die Stromversorgung angeschlossen ist. • Positionieren Sie die Kamera, den Router oder beides neu, um die Signalstärke zu verbessern.
Das Bild ist nicht klar	<ul style="list-style-type: none"> • Überprüfen Sie das Kameraobjektiv, gegen die Schmutz, Staub und Spinnweben. Reinigen Sie das Objektiv mit einem weichen, sauberen Tuch. • Entfernen Sie die Kunststoff-Abdeckung des Kameraobjektivs.
Kein Ton	<ul style="list-style-type: none"> • Stellen Sie sicher, dass die Audiofunktion der Kamera aktiviert ist. • Stellen Sie sicher, dass Audio auf dem Anzeigergerät aktiviert ist.
Personenerkennung funktioniert nicht	Stellen Sie sicher, dass Sie Human Detection in der Benutzeroberfläche Geräteeinstellungen der Imou Life App aktiviert haben.
Kamera hängt unten fest	Überprüfen Sie die Datenschutzeinstellungen in der Imou Life-App.
QR-Code kann nicht gescannt werden	<ul style="list-style-type: none"> • Reinigen Sie das Kameraobjektiv Ihres Smartphones. • Stellen Sie sicher, dass der QR-Code ausreichend beleuchtet ist. • Halten Sie den QR-Code nicht zu nah an die Kamera.



Guía de inicio rápido

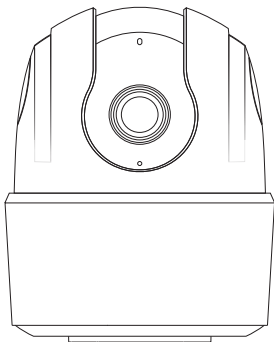

www.imoulife.com

Bienvenido

Gracias por elegir Imou.

Nos comprometemos a proporcionarle productos fáciles para el hogar inteligente. Si tiene problemas usando el producto, por favor diríjase a nuestro equipo de atención al cliente antes de devolver su producto.

Nuestro correo electrónico de servicio:
service.global@imoulife.com.

Puede encontrar más información y vídeos acerca de la instalación, además de preguntas frecuentes en:
imoulife.com/support/help o escanee este código QR para obtener ayuda.

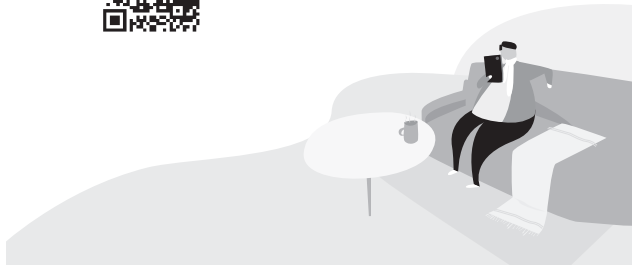

Contenido del paquete



1 cámara



1 cable de alimentación



1 adaptador eléctrico



1 plantilla de posicionamiento



1 guía de inicio rápido



1 bolsa con tornillos

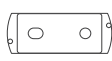

1 disco de montaje

Presentación de la cámara

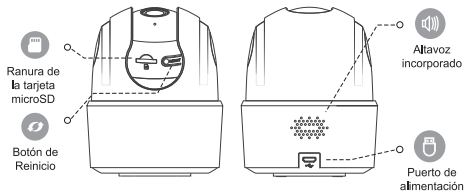
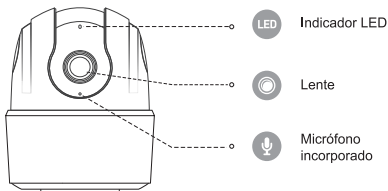

Nota: mantenga pulsado el botón de reinicio durante 10 segundos para reiniciar la cámara.

La descripción del indicador LED se incluye en la siguiente tabla.

Estado de LED	Estado del dispositivo
Desactivar	<ul style="list-style-type: none"> ● Desconectado/LED apagado ● Nuevo arranque después del reinicio
Luz roja encendida	<ul style="list-style-type: none"> ● Arranque ● Avería del dispositivo
Luz verde parpadeante	<ul style="list-style-type: none"> ● En espera de la red
Luz verde encendida	<ul style="list-style-type: none"> ● Funcionando correctamente
Luz roja parpadeante	<ul style="list-style-type: none"> ● Fallo de conexión de red
Luz verde y roja parpadeando alternativamente	<ul style="list-style-type: none"> ● Actualización de firmware

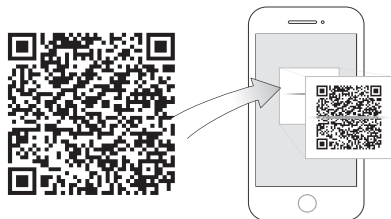

i Consejos

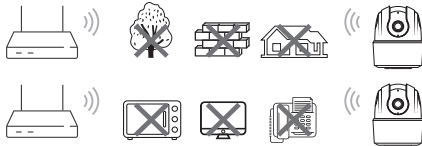

Para garantizar el mejor rendimiento inalámbrico posible, por favor asegúrese de que no hay obstáculos ni interferencias electromagnéticas entre la cámara y el enrutador.

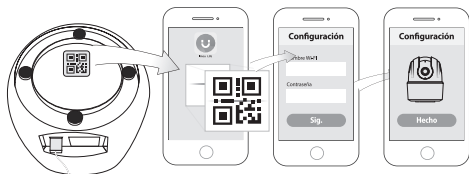

Montaje en el techo (Opcional)

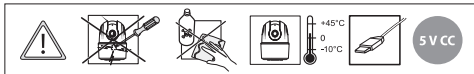
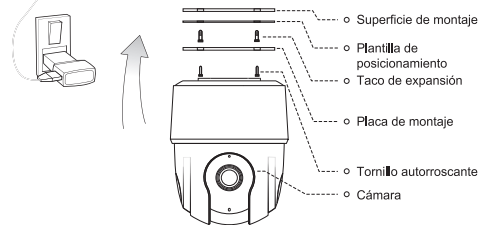

Solución de problemas

Problema	Solución
No se puede configurar la cámara.	<ul style="list-style-type: none"> Asegúrese de que su teléfono móvil y la cámara estén dentro del alcance del router Wi-Fi. Asegúrese de que el indicador LED de la cámara parpadee en verde.
Cómo encontrar la contraseña Wi-Fi de la cámara	Es el código de seguridad en la etiqueta del dispositivo.
Sin imagen o dispositivo está desconectado	<ul style="list-style-type: none"> Asegúrese de que el indicador LED de la cámara parpadee en verde. De lo contrario, consulte la sección «Estado del LED» para conocer los detalles. Asegúrese de que la cámara esté conectada correctamente a la alimentación utilizando el adaptador de alimentación USB incluido. Vuelva a colocar la cámara, el router o ambos para mejorar la intensidad de la señal.
La imagen no es clara	<ul style="list-style-type: none"> Revise la lente de la cámara en busca de suciedad, polvo y telarañas. Limpie la lente con un paño suave y limpio. Retire la cubierta de vinilo de la lente de la cámara.
No hay sonido	<ul style="list-style-type: none"> Asegúrese de que la función de audio de la cámara esté activada. Asegúrese de que el audio esté activado en el dispositivo de visualización.
La detección humana no funciona correctamente	Asegúrese de haber habilitado la detección humana en la interfaz Configuración del dispositivo de la aplicación Imou Life.
La cámara está bloqueada apuntando hacia abajo	Verifique la configuración del modo de privacidad en la aplicación Imou Life.
No se puede escanear el código QR	<ul style="list-style-type: none"> Limpie la lente de la cámara de su teléfono inteligente. Asegúrese de que haya suficiente luz para escanear el código QR. No sostenga el código QR demasiado cerca de la cámara.

imou

Guide de démarrage rapide

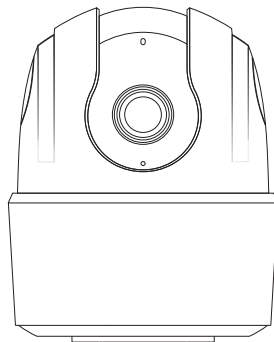

www.imoulife.com

Bienvenue

FR Merci d'avoir choisi Imou.

Nous nous engageons à vous fournir des produits de maison intelligente faciles à utiliser. Si vous rencontrez des difficultés lors de l'utilisation du produit, veuillez contacter notre équipe technique avant de renvoyer votre produit.

Notre courriel de service : service.global@imoulife.com.

Vous trouverez des instructions d'installation détaillées, des vidéos et une foire aux questions à l'adresse suivante : imoulife.com/support/help ou scannez ce code QR pour accéder à la page d'aide.



Contenu de l'emballage

FR



1 caméra



1 câble d'alimentation



1 adaptateur d'alimentation



1 schéma de positionnement



1 guide de démarrage rapide



1 Jeu de vis



1 plaque de montage

Présentation de la caméra

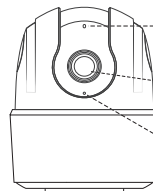

Indicateur LED



Objectif



Micro Intégré



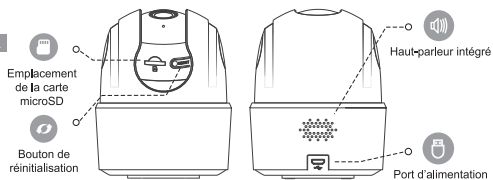

Remarque : Maintenez le bouton de réinitialisation enfoncé pendant 10 s pour réinitialiser l'appareil.

La description des indicateur LED est incluse dans le tableau suivant.

Etat de LED	État des appareils
Désactivé	<ul style="list-style-type: none"> Appareil éteint/LED éteinte Redémarrage après remise à zéro
Allumé en rouge	<ul style="list-style-type: none"> Démarrage Dysfonctionnement de l'appareil
Clignotant en vert	<ul style="list-style-type: none"> En attente de connexion de réseau
Allumé en vert	<ul style="list-style-type: none"> Fonctionnement correcte
Clignotant en rouge	<ul style="list-style-type: none"> Échec de connexion de réseau
Voyants vert et rouge clignotant alternativement	<ul style="list-style-type: none"> Mise à jour du microprogramme

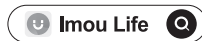
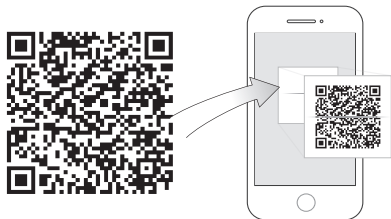

i Conseils

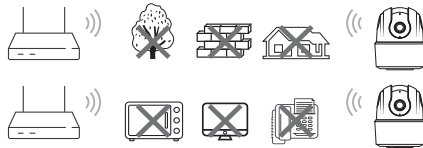

Pour garantir les meilleures performances sans fil, veuillez vous assurer qu'il n'y a pas d'obstacles ni d'interférences électromagnétiques entre la caméra et le routeur.

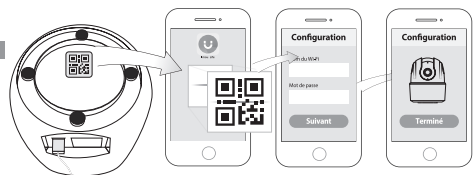

Montage au plafond (en option)

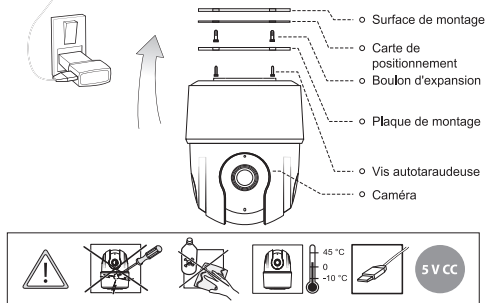

Dépannage

Problème	Solution
Impossible de configurer la caméra	<ul style="list-style-type: none"> Assurez-vous que votre téléphone mobile et la caméra sont à portée de votre routeur Wi-Fi. Assurez-vous que l'indicateur LED de la caméra clignote en vert.
Comment trouver le mot de passe Wi-Fi de la caméra	Il s'agit du code de sécurité figurant sur l'étiquette de l'appareil.
Pas d'image ou l'appareil est hors ligne	<ul style="list-style-type: none"> Assurez-vous que l'indicateur LED de la caméra clignote en vert. Sinon, voir la section « État de LED » pour plus de détails. Assurez-vous que la caméra est correctement connectée à l'alimentation en utilisant l'adaptateur d'alimentation USB inclus. Repositionnez la caméra, le routeur ou les deux pour améliorer la puissance du signal.
L'image n'est pas claire	<ul style="list-style-type: none"> Vérifiez que l'objectif de la caméra ne contient pas de saleté, de poussière ou de toiles d'araignées. Nettoyez la lentille à l'aide d'un chiffon doux et propre. Retirez le couvercle en vinyle de l'objectif de la caméra.
Pas de son	<ul style="list-style-type: none"> Assurez-vous que la fonction audio de la caméra est activée. Assurez-vous que le son est allumé sur l'appareil de visualisation.
La détection humaine ne fonctionne pas	Assurez-vous d'avoir activé la « Détection humaine » dans l'écran des paramètres de l'appareil de l'application Imou Life.
Caméra tournée vers le bas	Vérifiez le réglage du mode de confidentialité dans l'application Imou Life.
Impossible de scanner le code QR	<ul style="list-style-type: none"> Nettoyez l'objectif de la caméra de votre téléphone mobile. Assurez-vous que le code QR est suffisamment éclairé. Ne tenez pas le code QR trop près de la caméra.

Imou

Guida rapida

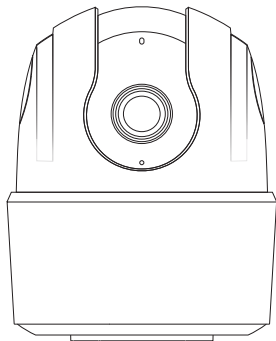

www.imoulife.com

Benvenuti

Grazie per aver scelto Imou.

Ci impegnamo a fornire ai nostri clienti utili soluzioni smart per la casa. In caso di problemi durante l'utilizzo del prodotto, si prega di contattare il nostro team di assistenza prima di restituire il prodotto.

La nostra e-mail per il servizio di assistenza:
service.global@imoulife.com.

Istruzioni, video e raccolte di domande frequenti contenenti informazioni dettagliate sull'installazione sono disponibili sul sito: imoulife.com/support/help. È anche possibile scansionare il codice QR per accedere alla pagina delle guide.

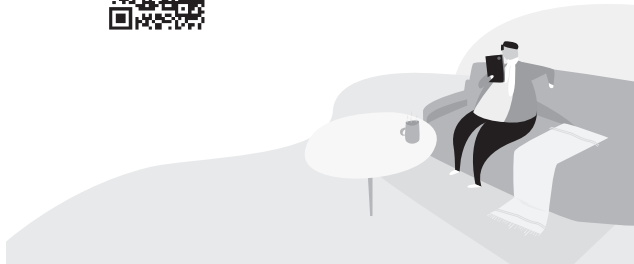

Contenuto della confezione

IT



1 telecamera



1 cavo di alimentazione



1 Adattatore



1 dima di posizionamento



1 guida rapida



1 Kit di viti



1 piastra di montaggio

Introduzione alla telecamera

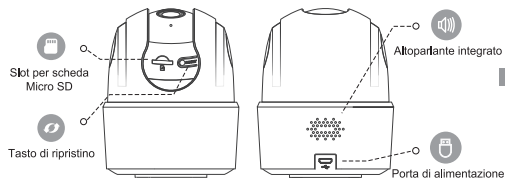
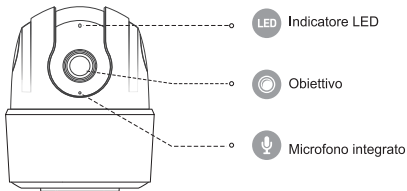

IT

Nota: Tenere premuto il pulsante reset per 10 secondi per reimpostare la telecamera.

La descrizione dell'indicatore LED è inclusa nella tabella seguente.

LED di stato	Stato del dispositivo
Disattivo	<ul style="list-style-type: none">Spento/LED spentoRiavvio dopo il ripristino
Luce rossa accesa	<ul style="list-style-type: none">AvvioMalfunzionamento del dispositivo
Luce verde lampeggiante	<ul style="list-style-type: none">In attesa di rete
Luce verde accesa	<ul style="list-style-type: none">Funzionamento normale
Luce rossa lampeggiante	<ul style="list-style-type: none">Connessione di rete non riuscita
Le luci verde e rossa lampeggiano alternatamente	<ul style="list-style-type: none">Aggiornamento del firmware

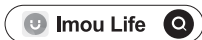
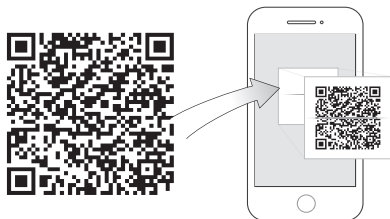

i Suggerimenti

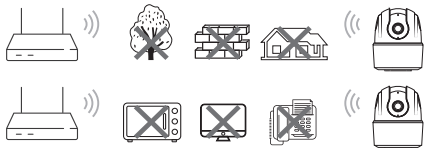

Per garantire le migliori prestazioni wireless possibili, assicurarsi che non ci siano ostacoli e interferenze elettromagnetiche tra la telecamera e il router.

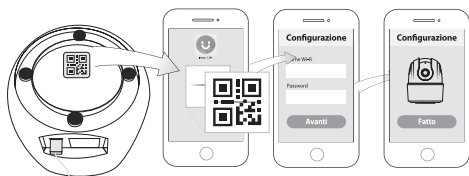

Montaggio a soffitto (opzionale)

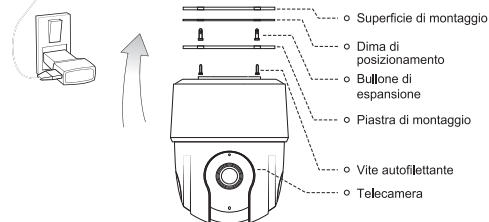

Risoluzione dei problemi

IT

Problema	Soluzione
Impossibile configurare la telecamera	<ul style="list-style-type: none">Assicurarsi che lo smartphone e la telecamera si trovino nel raggio di copertura del router Wi-Fi.Assicurarsi che l'indicatore LED sulla telecamera lampeggi in verde.
Come trovare la password Wi-Fi della telecamera	È il codice di sicurezza riportato sull'etichetta del dispositivo.
Nessuna immagine oppure il dispositivo è offline	<ul style="list-style-type: none">Assicurarsi che l'indicatore LED sulla telecamera lampeggi in verde. In caso contrario, fare riferimento alla sezione "Stato LED" per maggiori dettagli.Assicurarsi che la telecamera sia correttamente collegata all'alimentazione tramite l'alimentatore USB in dotazione.Posizionare opportunamente telecamera e router per migliorare la potenza del segnale.
L'immagine non è chiara	<ul style="list-style-type: none">Controllare che l'obiettivo della telecamera non sia ricoperto da sporco, polvere o ragnatele. Pulire l'obiettivo con un panno morbido inumidito.Rimuovere il coperchio in vinile dall'obiettivo della telecamera.
Non c'è suono	<ul style="list-style-type: none">Assicurarsi che la funzione audio della telecamera sia attivata.Assicurarsi che l'audio del dispositivo di visualizzazione sia attivato.
Il rilevamento di persone non funziona	Assicurarsi di aver attivato il rilevamento di persone nell'interfaccia Impostazioni dispositivo dell'app Imou Life.
Telecamera bloccata verso il basso	Controllare le impostazioni della Modalità privacy sull'app Imou Life.
Scansione codice QR non riuscita	<ul style="list-style-type: none">Pulire l'obiettivo della fotocamera dello smartphone.Controllare che il codice QR sia adeguatamente illuminato.Non tenere il codice QR troppo vicino alla fotocamera.

imou

Snelstarhandleiding

NL

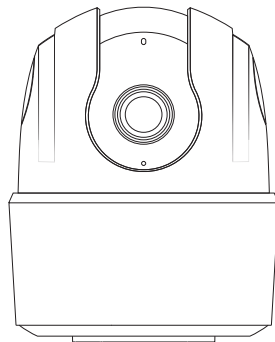

www.imoulife.com

Welkom

Bedankt dat U voor Imou heeft gekozen.

Ons doel is om U slimme producten voor thuis aan te bieden, eenvoudig in gebruik. Indien U problemen met het product heeft, neem eerst contact op met ons ondersteuningsteam, voor het product te retourneren.

Emailadres van ons ondersteuningsteam:
service.global@imoulife.com.

Gedetailleerde installatie instructies, videos, en veelgestelde vragen, kunt U vinden op imoulife.com/support/help, of scan deze QR code.



Inhoud verpakking



Camera x1



Voedingskabel x1



Voedingsadapter x1



Boormaal x1



Snelstartgids x1



Schroevenpakket x 1



Montageplaat x1

Introductie camera

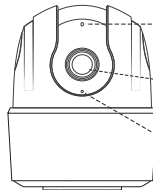

LED indicator



Lens



Ingebouwde
microfoon

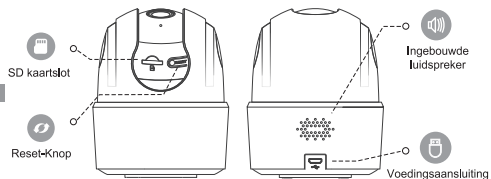

Notitie: Houd de resetknop 10 seconden ingedrukt om de camera te resetten.

De betekenis van de LED indicator staat in de volgende tabel.

LED status	Status apparaat
Uit	<ul style="list-style-type: none"> Uitgeschakeld/LED is uitgeschakeld Herstarten na reset
Rode LED aan	<ul style="list-style-type: none"> Bezig met opstarten Apparaat storing
Groene LED knippert	<ul style="list-style-type: none"> Wacht op netwerk
Groene LED aan	<ul style="list-style-type: none"> Werkt zoals dat moet
LED knippert rood	<ul style="list-style-type: none"> Netwerkverbinding mislukt
Groene en rode LED knipperen afwisselend	<ul style="list-style-type: none"> Bijwerken firmware

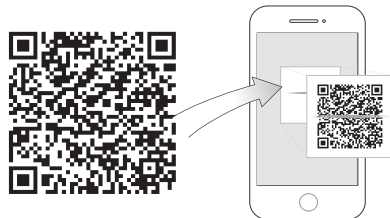

i Tips

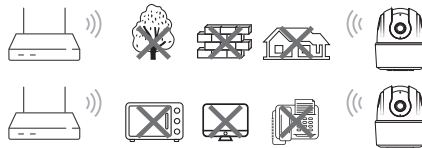

Voor de best mogelijke wifi verbinding, maak zeker dat er geen obstakels en/of elektromagnetische interferentie aanwezig is tussen de camera en de router.

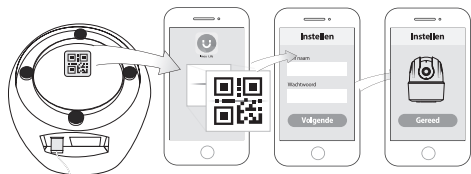

Plafondbevestiging (optioneel)

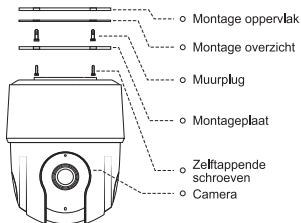

Storingsanalyse

Probleem	Oplossing
Kan de camera niet configureren	<ul style="list-style-type: none"> Zorg dat uw smartphone en camera binnen het bereik van uw wifi router zijn. Controleer of de LED indicator op de camera groen knippert.
Hoe het wifi wachtwoord van de camera vinden	De veiligheidscode op het apparaatlabel.
Geen beeld, of het apparaat is offline	<ul style="list-style-type: none"> Controleer of de LED indicator op de camera groen knippert. Zie de sectie "LED status" voor details indien dit niet het geval is. Zorg dat de camera correct is verbonden met de meegeleverde USB voeding. Herpositioneer de camera, router, of beiden, om de signaalsterkte te verbeteren.
Beeld is niet helder	<ul style="list-style-type: none"> Controleer de cameralens op vuil, stof en spinnenwebben. Reinig de lens met een zachte, schone doek. Verwijder het vinyl deksel op de cameralens.
Geen audio	<ul style="list-style-type: none"> Zorg dat de audiofunctie van de camera is ingeschakeld. Zorg dat voldoende audiovolume is ingesteld op het beeldapparaat.
Persoonsdetectie werkt niet	Zorg dat U in de Imou Life App, onder apparaatinstellingen , persoonsdetectie heeft ingesteld.
Camera zit vast in neerwaartse stand	Controleer de privacymodus instellingen in de Imou Life App.
QR code scannen mislukt	<ul style="list-style-type: none"> Maak de cameralens van uw smartphone schoon. Zorg dat de QR code goed verlicht is. Houd de QR code niet te dicht bij de camera.



Guia de Início Rápido

PT

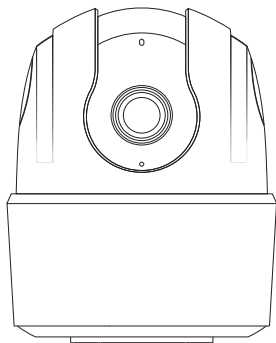

www.imoulife.com

Bem-vindo

Obrigado por escolher a Imou. Estamos empenhados em fornecer-lhe produtos Casa inteligente simples. Se tiver problemas ao utilizar o produto, contacte a nossa equipa de assistência antes de devolver o produto.

O nosso e-mail de assistência:
service.global@imoulife.com.

As instruções de instalação detalhadas e vídeos, bem como perguntas frequentes podem ser encontradas em: imoulife.com/support/help ou efetue a leitura deste código QR para aceder à página de ajuda.



PT

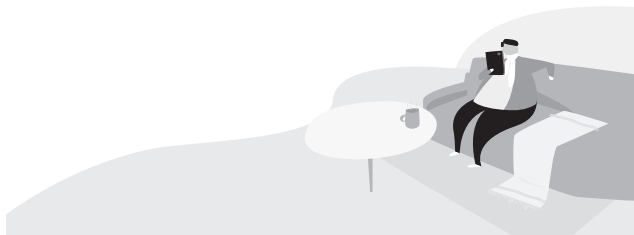

Conteúdo da embalagem

PT

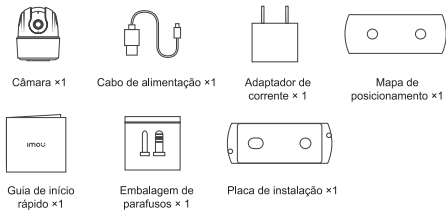

Introdução à câmara

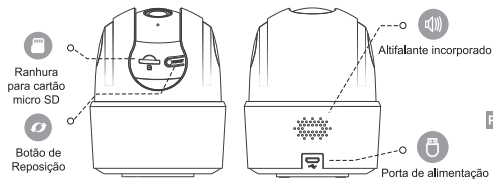
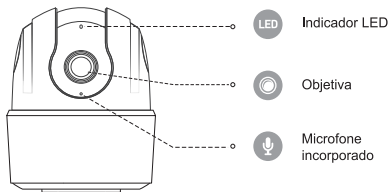

PT

Nota: premir continuamente durante 10 s o botão de reposição para repor a câmara.

A descrição do indicador LED está incluída na seguinte tabela.

Estado do LED	Estado do dispositivo
Desligado	<ul style="list-style-type: none">Desligado/LED desligadoReiniciar após a reposição
Luz vermelha acesa	<ul style="list-style-type: none">ArranqueAvaria do dispositivo
Luz verde intermitente	<ul style="list-style-type: none">À espera da rede
Luz verde acesa	<ul style="list-style-type: none">A funcionar corretamente
Luz vermelha intermitente	<ul style="list-style-type: none">Ligação à rede falhou
Luz verde e vermelha a piscar alternadamente	<ul style="list-style-type: none">Atualização do firmware

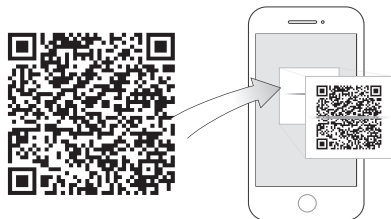

i Dicas

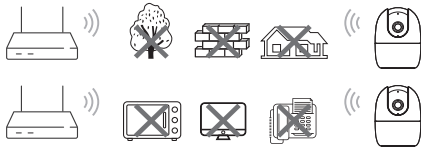

Para assegurar o melhor desempenho possível do sistema sem fios, certifique-se de que não existem obstáculos e interferência eletromagnética entre a câmara e o router.



Montagem no teto (Opcional)

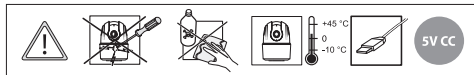
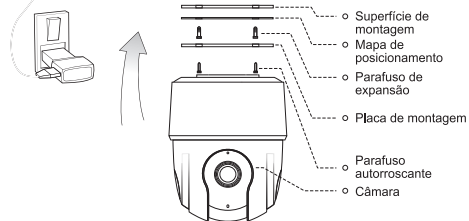

Resolução de problemas

Problema	Solução
Não é possível configurar a câmara	<ul style="list-style-type: none">• Certifique-se de que o seu smartphone e a câmara se encontram dentro do alcance do router de Wi-Fi.• Certifique-se de que o indicador LED na câmara está verde intermitente.
Como localizar a palavra-passe da rede Wi-Fi da câmara.	É o código de segurança na etiqueta do dispositivo.
Nenhuma imagem ou dispositivo offline	<ul style="list-style-type: none">• Certifique-se de que o indicador LED na câmara está verde intermitente. Consulte a secção "Estado do LED" para obter detalhes, caso seja necessário.• Certifique-se de que a câmara se encontra corretamente ligada à corrente com o transformador USB incluído.• Reposicione a câmara, o router ou ambos para melhorar a intensidade do sinal.
A imagem não está nítida	<ul style="list-style-type: none">• Verifique se a objetiva da câmara tem sujidade, pó ou teias de aranha. Limpe a objetiva com um pano limpo e macio.• Retire a tampa de vinil da objetiva da câmara.
Sem áudio	<ul style="list-style-type: none">• Certifique-se de que a função de áudio na câmara está ativada.• Certifique-se de que o áudio está ligado no dispositivo de visualização.
A Deteção humana não funciona	Certifique-se de que ativou a Deteção humana na interface Definições do dispositivo da aplicação Imou Life.
A câmara ficou presa em baixo	Verifique a definição de Modo de privacidade na aplicação Imou Life.
Falha ao ler o código QR	<ul style="list-style-type: none">• Limpe a objetiva da câmara do seu smartphone.• Certifique-se de que existe luz suficiente no código QR.• Não aproxime demasiado o código QR da câmara.

Imou

دليل التشغيل السريع

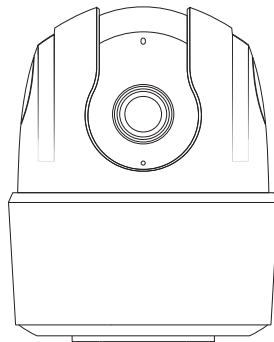

www.imoulife.com

محتويات العبوة



الكاميرا - قطعة واحدة



كابل طاقة - قطعة واحدة



محوّل طاقة- قطعة واحدة



مخطط تعيين الموضع - قطعة واحدة



دليل التشغيل السريع - نسخة واحدة



عونة براغي - قطعة واحدة



صفحة تركيب- قطعة واحدة

مرحباً

شكراً لك على اختيار Imou. نأخذ على عاتقنا تقديم منتجات منزلية ذكية وسهلة من أجلك. إذا كانت لديك مشكلات بخصوص استخدام المنتج، فيرجى الاتصال بفريق الدعم التابع لنا قبل إرجاع المنتج.

البريد الإلكتروني للخدمة: service.global@imoulife.com.

يمكن الرجوع إلى تعليمات التركيب المفصلة ومقاطع الفيديو والأسئلة الشائعة على: imoulife.com/support/help أو مسح رمز QR ضوئياً للوصول إلى صفحة التعليمات.



مقدمة عن الكاميرا

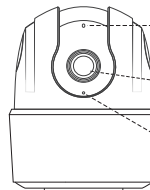

مؤشر صوتي LED

عدسة

ميكروفون مدمج

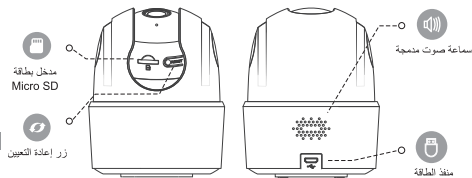

ملاحظة: اضغط مع الاستمرار على زر إعادة التعيين لمدة 10 ثوانٍ لإعادة تعيين الكاميرا.

يتضمن الجدول التالي توضيح مؤشر LED.

حالة الجهاز	حالة LED
<ul style="list-style-type: none"> تم فصل الطاقة / تم إيقاف تشغيل LED تتم إعادة التشغيل بعد إعادة التعيين تشغيل 	إيقاف
<ul style="list-style-type: none"> عطل بالجهاز 	مضاء باللون الأحمر
<ul style="list-style-type: none"> في انتظار الشبكة 	يومض بالضوء الأخضر
<ul style="list-style-type: none"> يعمل بشكل صحيح فشل الاتصال بالشبكة 	مضاء باللون الأخضر يومض بالضوء الأحمر
<ul style="list-style-type: none"> تحديث البرنامج الأساسي 	يومض بالضوء الأخضر والأحمر بالتناوب



نصائح ⓘ

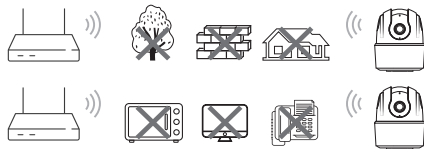

لضمان أفضل أداء لاسلكي ممكن، يرجى التأكد من عدم وجود أي عوائق وأي تداخل كهرومغناطيسي بين الكاميرا والموجه.



تركيب بالسقف (اختياري)

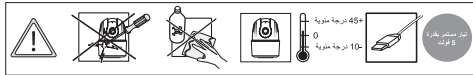
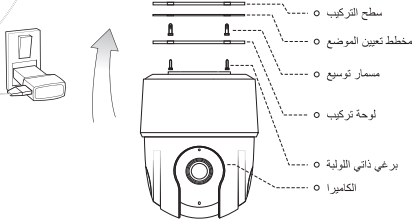

شكرًا لتفضيلنا بظرف
5

استكشاف الأعطال وإصلاحها

المشكلة	الحل
تعذر اعداد الكاميرا	<ul style="list-style-type: none"> • تأكد من أن الهاتف الذكي والكاميرا ضمن نطاق موجه شبكة Wi-Fi. • تأكد من أن مؤشر الموجود في الكاميرا يومض باللون الأخضر LED.
طريقة العثور على كلمة مرور شبكة Wi-Fi الخاصة بالكاميرا	<p>هو رمز الأمان الموجود على ملصق الجهاز.</p>
لا توجد صورة أو الجهاز غير متصل	<ul style="list-style-type: none"> • تأكد من أن مؤشر الموجود في الكاميرا يومض باللون الأخضر LED. • راجع قسم "حالة LED" لمعرفة التفاصيل إذا كانت البيانات مختلفة. • تأكد من أن الكاميرا متصلة بطريقة صحيحة بالطاقة باستخدام محوّل الطاقة الملحق. • عدّل موضع الكاميرا أو الموجه أو كليهما لتحسين قوة الإشارة.
الصورة غير واضحة	<ul style="list-style-type: none"> • افحص عدسة الكاميرا اذا وجد الأوساخ والأتربة وشبكات العنكبوت نظف العدسة بقطعة قماش ناعمة ونظيفة. • قم بإزالة غلاف الفيلد الموجود على عدسة الكاميرا.
لا يوجد صوت	<ul style="list-style-type: none"> • تأكد من أن وظيفة الصوت في الكاميرا قيد التشغيل. • تأكد من رفع الصوت في جهاز العرض.
خاصية اكتشاف البشر لا تعمل	<p>تأكد من أنك قد قمت بتمكين خاصية اكتشاف البشر في واجهة (إعدادات الجهاز) بتطبيق Imou Life App.</p>
الكاميرا عالقة في الاتجاه الأسفل	<p>تحقق من إعداد وضع الخصوصية في تطبيق Imou Life App.</p>
فشل مسح رمز QR ضوئيًا	<ul style="list-style-type: none"> • نظف عدسة كاميرا هاتفك الذكي. • تأكد من وجود ضوء كافٍ مملط على رمز QR. • لا تضع رمز QR قريبًا من الكاميرا.

