

# ELITE

## SHARK



 **Sharkoon**

**CA300T**  
ATX PC CASE

# CASE VERSIONS

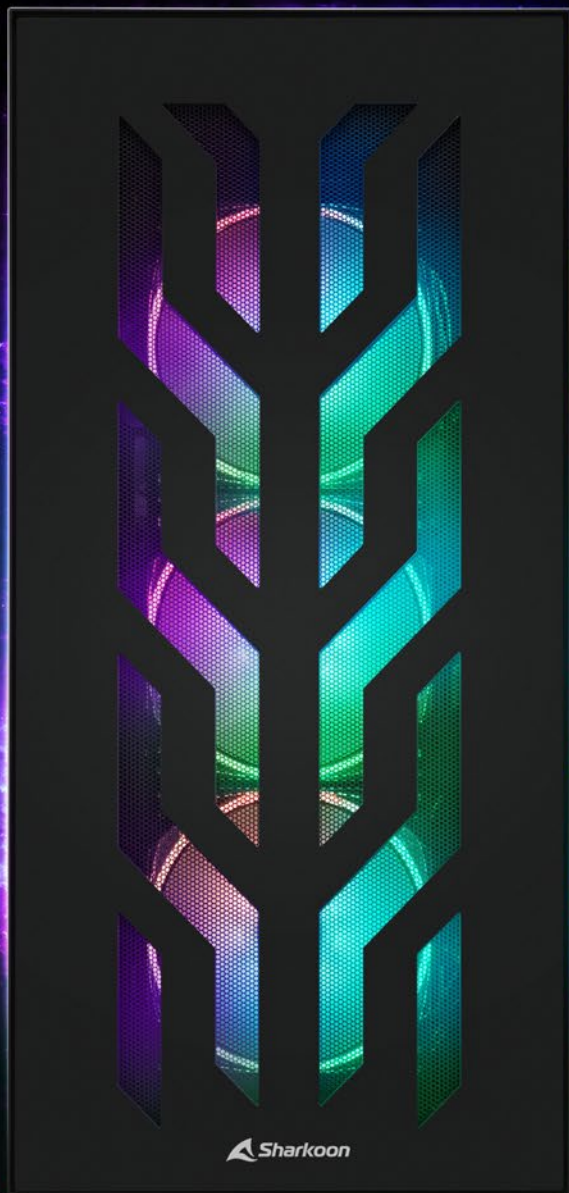

**BLACK EDITION**



**WHITE EDITION**

Futuristic front, noble design, and a sophisticated layout – that is the CA300T. The large, sturdy ATX tower from our ELITE SHARK series is aimed at ambitious PC enthusiasts and is equipped with a range novel features. Among these are a side-mounted RGB illuminated I/O panel, two tempered glass side panels, a hinged compartment for cabling as well as a three-layer top panel consisting of a ventilation opening, a magnetically attached dust filter and a perforated top cover. The steel front panel casts an imposing figure with its impressive angular patterns, which is highlighted in front by three highly luminous RGB LED fans. As expected within an ELITE SHARK case, there is also an enormous amount of space inside for powerful hardware and elaborate PC builds.

# 8-PORT ADDRESSABLE RGB CONTROLLER

The ELITE SHARK CA300T is supplied with an 8-Port Addressable RGB Controller for digitally addressable LEDs. With compatible mainboards, this will function as a hub for up to eight addressable LED components which, via the mainboard software, will illuminate in up to 16.8 million colors.

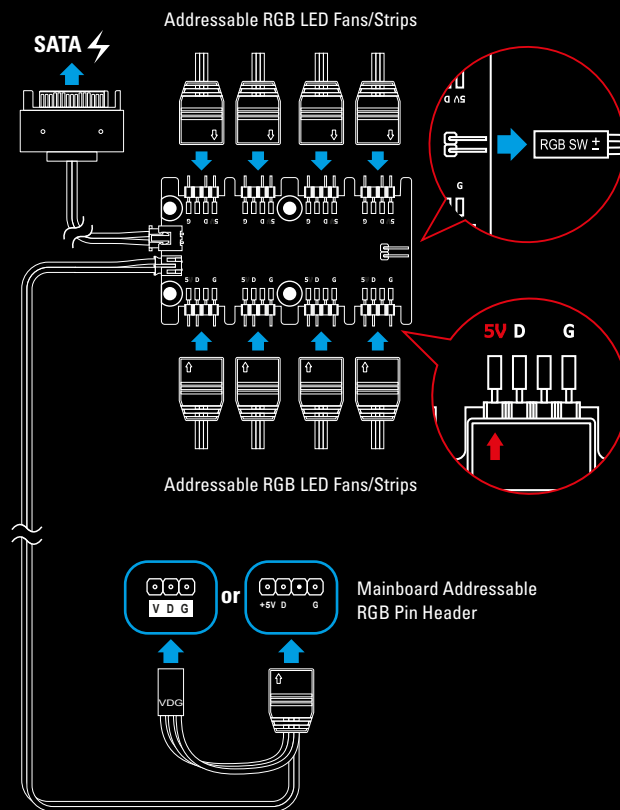

## MANUAL COLOR CONTROL

For mainboards without headers for addressable RGB illumination, up to eight addressable LED components can be directly illuminated and controlled via the 8-Port Addressable RGB Controller.

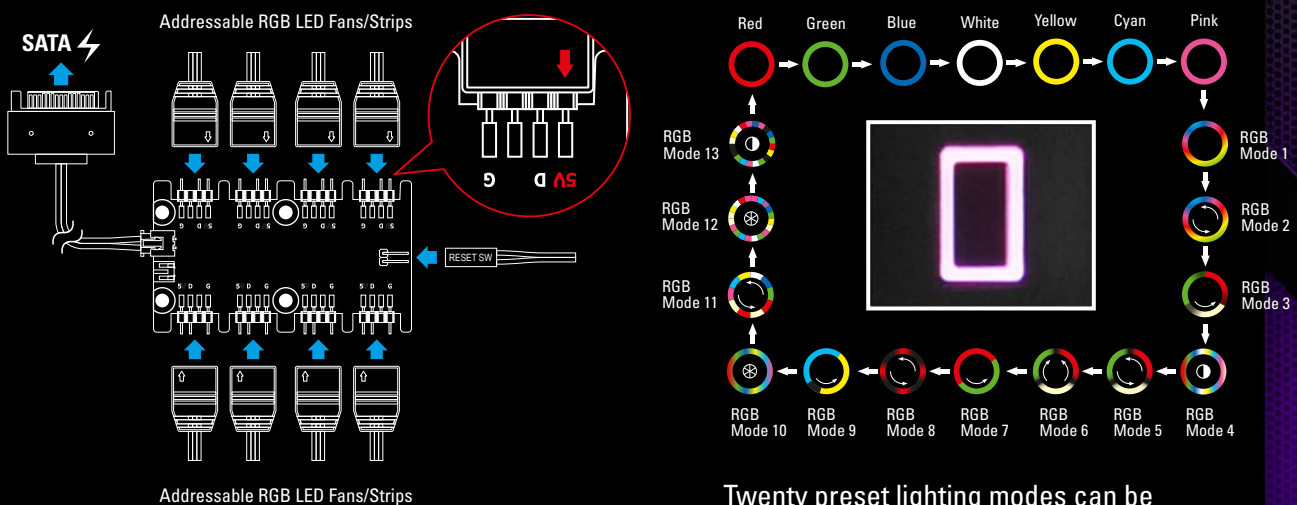

Twenty preset lighting modes can be consecutively selected using the dedicated RGB switch on the I/O panel of the case. If desired, the illumination can also be completely switched off.

# EASY TO INTEGRATE

The pre-installed addressable RGB fan and controller are certified for Asus Aura Sync, MSI Mystic Light Sync, Gigabyte Fusion and ASRock Polychrome SYNC.



## ADDRESSABLE RGB

Sharkoon products marked with the "ADDRESSABLE RGB" logo are compatible with mainboards which have headers for addressable RGB LED fans and strips. The headers should have the pin configuration 5V-D-coded-G or 5V-D-G. Examples of these RGB connections from the most important mainboard manufacturers are shown below. The RGB pin configuration is independent of manufacturer. However, the naming and marking of these connections may vary between manufacturers. For further information concerning compatibility, refer to the manual of your mainboard, or visit the manufacturer's website.

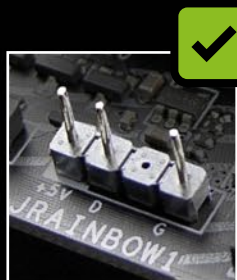

MSI

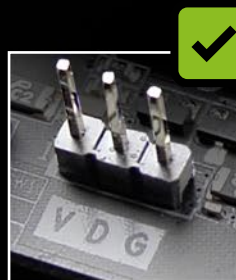

GIGABYTE

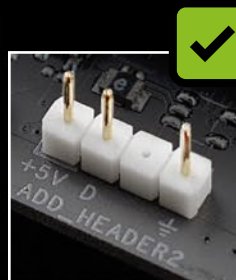

ASUS

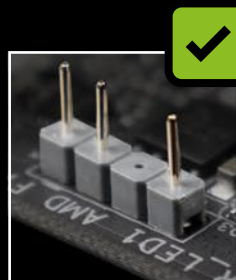

ASROCK

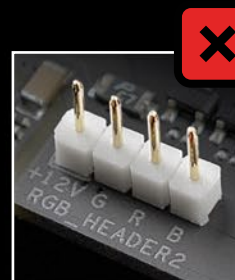

ASUS

# STYLISH SHOWCASE FOR PREMIUM COMPONENTS

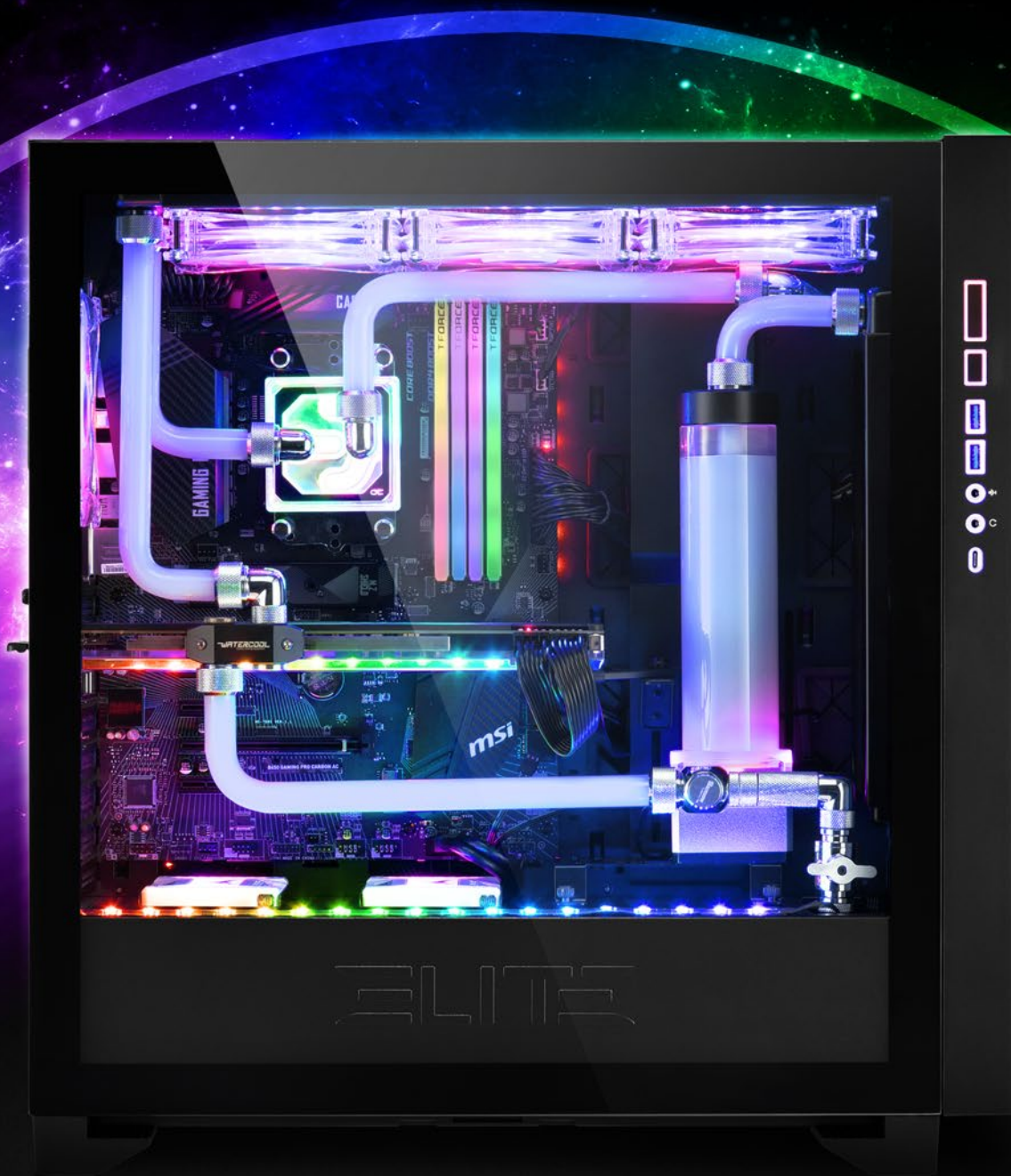

Hardware which has been built into an ELITE SHARK case deserves to be seen. Therefore, we have outfitted the CA300T with two tempered glass side panels. The left side panel provides full insight into the interior of the case so that installed components can be perfectly displayed. With the right side panel, the lowest area of the tempered glass is tinted black so that the components inside the power supply tunnel do not distract from the overall visual effect of the case. SSDs with RGB elements or imposing HDDs come here into their own. Cable tangles don't have a chance: Cabling can simply disappear inside a roomy cable compartment, which can be opened and closed, as well as behind a movable cable cover.

# OPTIONAL VERTICAL INSTALLATION FOR GRAPHICS CARDS



The CA300 is designed for an optimal view of the installed components. For classically mounted graphics cards, an adjustable graphics card holder with a rubber contact surface is pre-installed. For the vertical installation of graphics cards, a separately available Vertical Graphics Card Kit\* has been developed. This consists of an easily attachable mount and a riser cable. The cable has been given extra length to allow enough room for additional expansion cards.

\*Not included.

# RGB ILLUMINATED I/O CONTROL PANEL

A special detail of the CA300T can be found on its already impressive front. Instead of positioning the I/O panel on the top of the case, as per common designs, we have placed it on the side. Buttons and connectors are now particularly easy to reach when the case is presented standing on a table. In addition to the usual audio and USB ports, we have also outfitted the CA300T case with a USB Type-C port. The finishing touch is that the side positioned I/O panel is given its own RGB illumination.



## ELITE, STEEL APPEARANCE

The expressive front panel with its pattern of geometrically designed openings, lends the PC case a futuristic style and makes the CA300T an immediate eye-catcher. In addition, the application of high-quality materials completes the impression of elegance: the top panel has been manufactured with solid metal and the steel front panel is set within a frame made of diamond-cut aluminium. The three RGB-LED fans provide colorful highlights and shine through the pattern of the front panel. An additional RGB LED fan on the rear panel adds more illumination to the inside of the case.

# PERFECT FOR SYSTEM COOLING

The cases of the ELITE SHARK series have been especially developed for high performance hardware builds. With up to seven locations for fans, the cases offer enough possibilities for customized airflow solutions. The full tower is more than ready for demanding water cooling systems due to its pre-installed mount for a reservoir and pump and the dedicated extra-long slots for easy installation. At the front, the case can take radiators with a giant 420 mm, and radiators up to 360 mm will find room under the top panel. If needed, a 120 mm radiator can be installed, replacing the pre-installed fan on the rear panel.



## Radiator Front Panel:

- 420 mm
- 360 mm
- 280 mm
- 240 mm
- 140 mm
- 120 mm

## Radiator Top Panel:

- 360 mm
- 280 mm
- 240 mm
- 140 mm
- 120 mm

## Radiator Rear Panel:

- 120 mm



# LARGE, STURDY TOWER WITH PLENTY OF SPACE

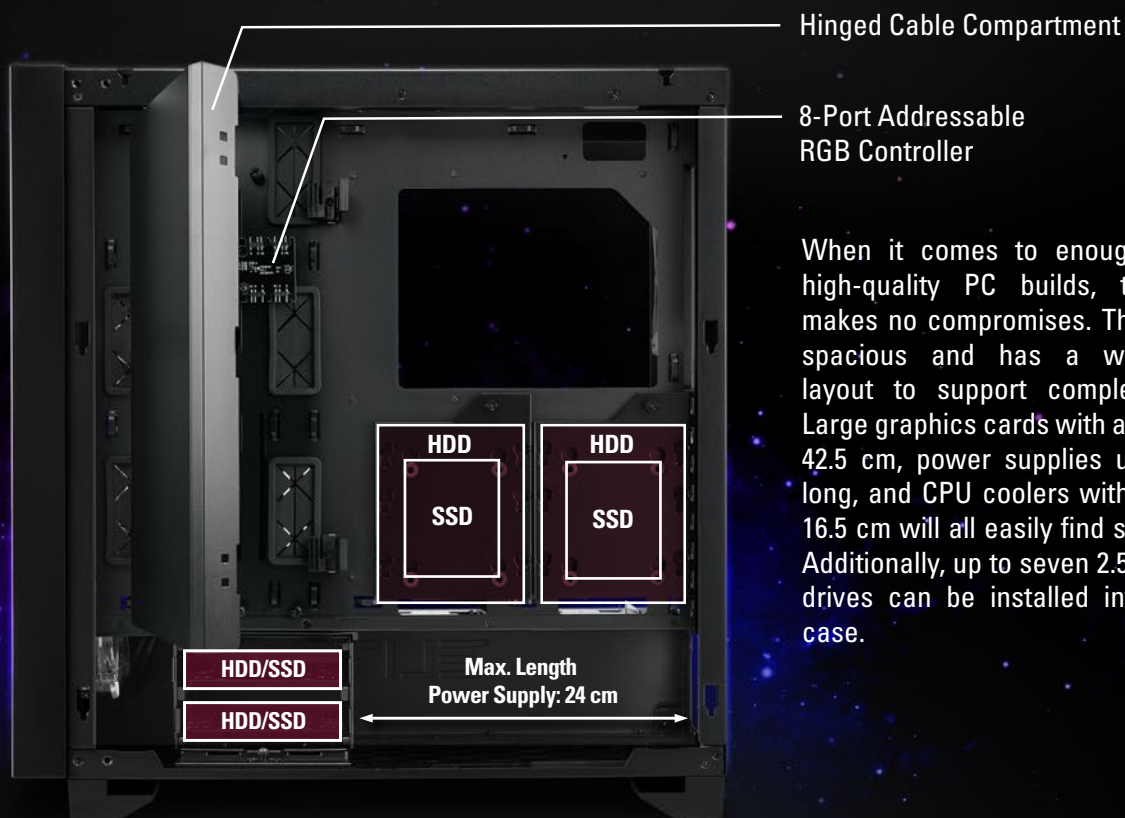
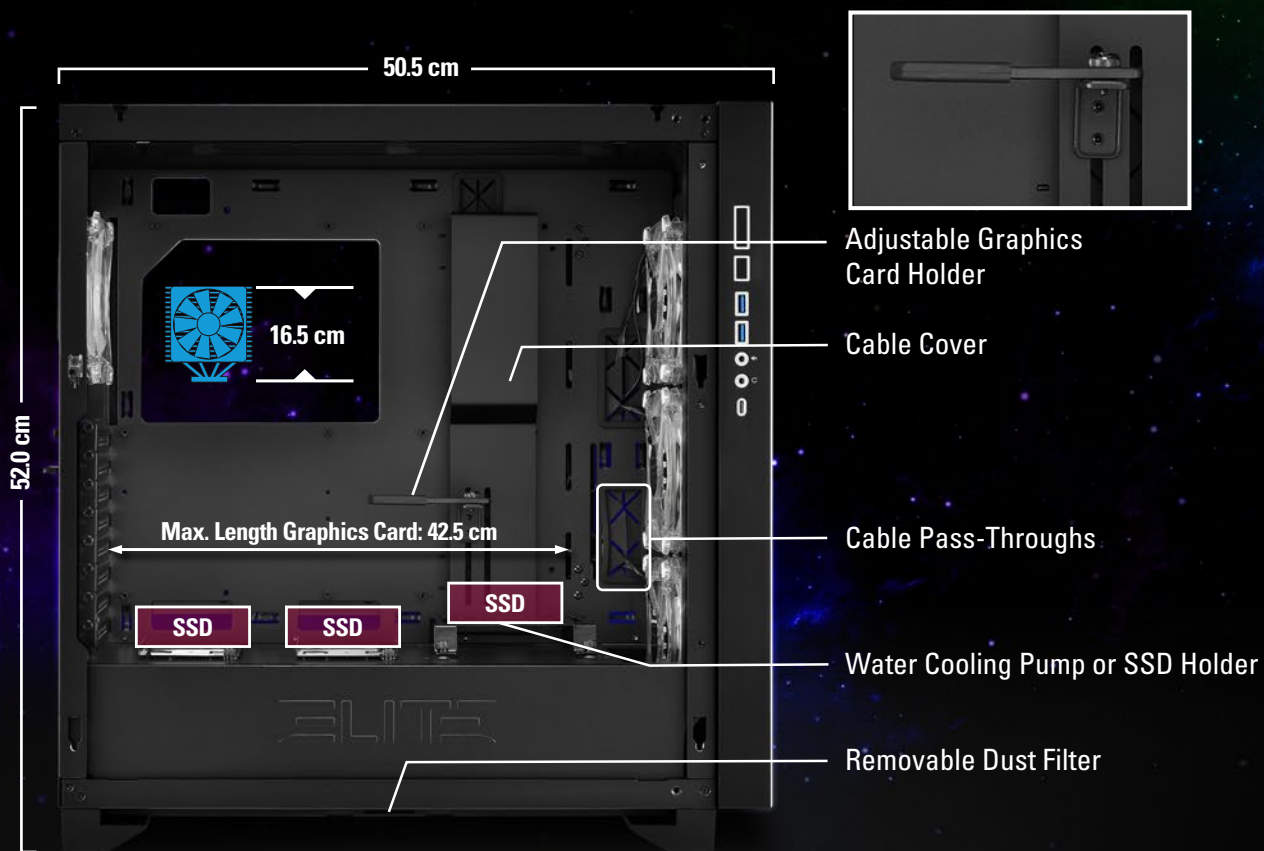

When it comes to enough room for high-quality PC builds, the CA300T makes no compromises. The interior is spacious and has a well-designed layout to support complex systems. Large graphics cards with a length up to 42.5 cm, power supplies up to 24 cm long, and CPU coolers with a height of 16.5 cm will all easily find space inside. Additionally, up to seven 2.5" or four 3.5" drives can be installed into the solid case.

# CONSTANT AIRFLOW FOR FULL POWER

Three pre-installed 120 mm RGB LED fans in the front and one in the rear provide the CA300T with a constant airflow. So that plenty of air can flow through the case, the front panel is equipped with a mesh grille. The top of the case even offers a complete opening with a perforated cover for fans and radiators.

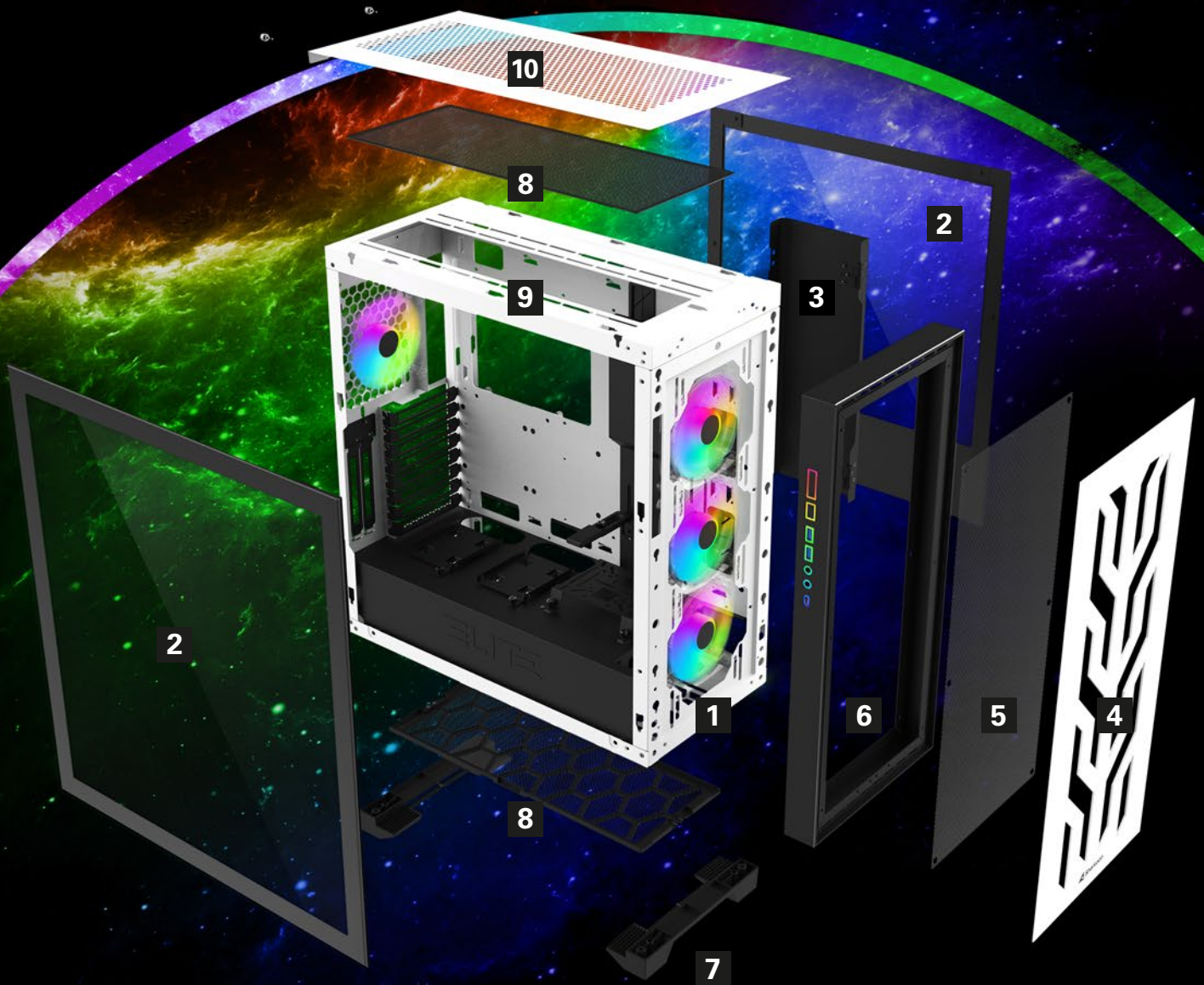

**1** 4x 120 mm Addressable RGB LED Fans

**2** Tempered Glass Side Panel

**3** Hinged Cable Compartment

**4** Metal Front Plate

**5** Dust Filter

**6** Aluminium Frame

**7** Stable Case Feet

**8** Removable Dust Filter

**9** Top Panel with Ventilation Opening

**10** Perforated Top Cover

# Specifications

## General:

■ Color Versions:	Black / White
■ Form Factor:	ATX / E-ATX
■ Expansion Slots:	8
■ Interior Painting:	✓
■ Cable Management System:	✓
■ Water Cooling Pump Holder:	✓
■ Side Panel:	2x Tempered Glass
■ Weight:	14.7 kg
■ Dimensions (L x W x H):	50.5 x 23.5 x 52.0 cm

## RGB Compatibility:

■ Type:	Addressable
■ Ports:	8
■ Manual Control:	20 Modes
■ Mainboard Compatibility:	MSI Mystic Light Sync, ASUS Aura Sync, Gigabyte RGB Fusion Ready, ASRock Polychrome SYNC
■ RGB Pinout:	5V-D-G & 5V-D-coded-G

## I/O:

■ Typ-C (USB 3.2 Gen 2) (Left):	1
■ USB 3.0 (Left):	2
■ Audio (Left):	✓

## Maximum Drive Bays:

■ 3.5":	4
■ 2.5":	7

## Fan Configuration:

■ Front Panel:	3x 120 mm Addressable RGB LED Fans (Pre-Installed) or 3x 140 mm Fans (Optional)
■ Rear Panel:	1x 120 mm Addressable RGB LED Fan (Pre-Installed)
■ Top Panel:	3x 120 mm or 2x 140 mm Fans (Optional)

## Compatibility:

■ Mainboard:	Mini-ITX, Micro-ATX, ATX, E-ATX
■ Max. Length Graphics Cards:	40.0 / 42.5 cm*
■ Max. Height CPU Cooler:	16.5 cm
■ Max. Length Power Supply:	24.0 cm
■ Max. Height Radiator incl. Fan (Front):	5.7 cm
■ Max. Height Radiator incl. Fan (Top):	6.0 cm
■ Radiators (Optional):	Up to 420 mm (Front Panel) Up to 360 mm (Top Panel) Up to 120 mm (Rear Panel)

## Package Contents:

■ ELITE SHARK CA300T
■ Accessory Set
■ Manual

\* Without front fan.

# ELITE SHARK

**CA300T**  
ATX PC CASE



[www.sharkoon.com](http://www.sharkoon.com)