



Digital Projector

User Manual

Warranty and Copyright information

Limited warranty

BenQ warrants this product against any defects in material and workmanship, under normal usage and storage.

Proof of purchase date will be required with any warranty claim. In the event this product is found to be defective within the warranty period, BenQ's only obligation and your exclusive remedy shall be replacement of any defective parts (labor included). To obtain warranty service, immediately notify the dealer from which you purchased the product of any defects.

Important: The above warranty shall be void if the customer fails to operate the product in accordance with BenQ's written instructions, especially the ambient humidity must be in-between 10% and 90%, temperature in-between 0°C and 35°C, altitude lower than 4920 feet, and avoiding to operate the projector in a dusty environment. This warranty gives you specific legal rights, and you may have other rights which vary from country to country.

For other information, please visit www.BenQ.com.

Copyright

Copyright 2022 by BenQ Corporation. All rights reserved. No part of this publication may be reproduced, transmitted, transcribed, stored in a retrieval system or translated into any language or computer language, in any form or by any means, electronic, mechanical, magnetic, optical, chemical, manual or otherwise, without the prior written permission of BenQ Corporation.

Disclaimer

BenQ Corporation makes no representations or warranties, either expressed or implied, with respect to the contents hereof and specifically disclaims any warranties, merchantability or fitness for any particular purpose. Further, BenQ Corporation reserves the right to revise this publication and to make changes from time to time in the contents hereof without obligation to notify any person of such revision or changes.

*DLP, Digital Micromirror Device and DMD are trademarks of Texas Instruments. Others are copyrights of their respective companies or organizations.

Patents

Please go to <http://patmarking.benq.com/> for the details on BenQ projector patent coverage.

Table of Contents

Warranty and Copyright information	2
Important safety instructions	4
Introduction	7
Shipping contents	7
Projector exterior view	8
Controls and functions.....	9
Positioning your projector	11
Choosing a location	11
Obtaining a preferred projected image size.....	12
Mounting the projector.....	13
Adjusting the projected image.....	14
Connection	16
Operation	17
Starting up the projector	17
Using the menus	19
Securing the projector	20
Switching input signal	21
Shutting down the projector	22
Menu operation	23
Basic menu	23
Advanced menu	24
Maintenance	42
Care of the projector	42
Light source information	43
Troubleshooting	45
Specifications	46
Projector specifications	46
Dimensions	47
Timing chart.....	48
RS232 command.....	50

Important safety instructions

Your projector is designed and tested to meet the latest standards for safety of information technology equipment. However, to ensure safe use of this product, it is important that you follow the instructions mentioned in this manual and marked on the product.

1. **Please read this manual before you operate your projector.** Save it for future reference.

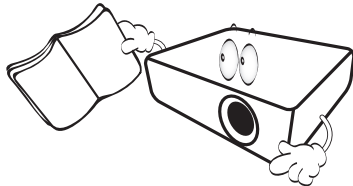

2. **Do not look straight at the projector lens during operation.** The intense light beam may damage your eyes.

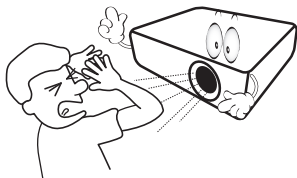

3. **Refer servicing to qualified service personnel.**

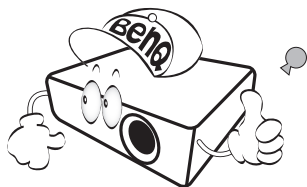

4. The light source becomes extremely hot during operation.

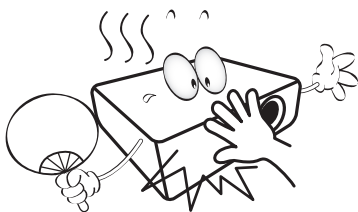

5. In some countries, the line voltage is NOT stable. This projector is designed to operate safely within a mains voltage between 100 to 240 volts AC, but could fail if power cuts or surges of ± 10 volts occur. **In areas where the mains voltage may fluctuate or cut out, it is recommended that you connect your projector through a power stabilizer, surge protector or uninterruptible power supply (UPS).**

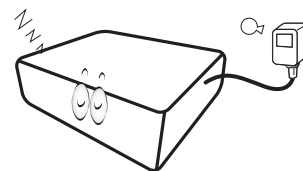

6. Do not block the projection lens with any objects when the projector is under operation as this could cause the objects to become heated and deformed or even cause a fire. To temporarily turn off the light source, press the **ECO BLANK** button.

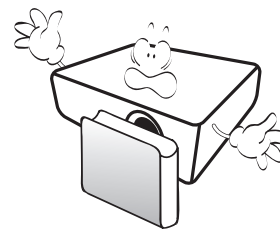

7. Do not operate light sources beyond the rated light source life.

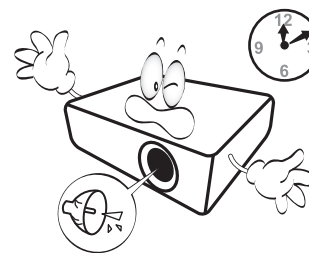

8. Do not place this product on an unstable cart, stand, or table. The product may fall, sustaining serious damage.

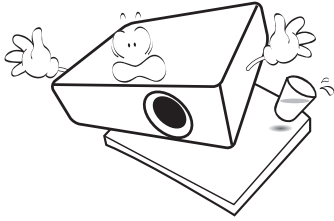

9. Do not attempt to disassemble this projector. There are dangerous high voltages inside which may cause death if you should come into contact with live parts.

Under no circumstances should you ever undo or remove any other covers. Refer servicing only to suitably qualified professional service personnel.

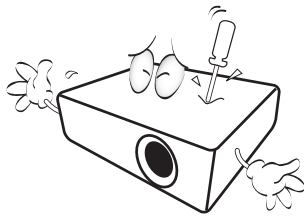

10. Do not block the ventilation holes.

- Do not place this projector on a blanket, bedding or any other soft surface.
- Do not cover this projector with a cloth or any other item.
- Do not place inflammables near the projector.

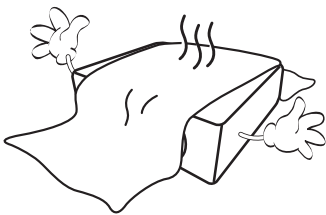

If the ventilation holes are seriously obstructed, overheating inside the projector may result in a fire.

11. Always place the projector on a level, horizontal surface during operation.

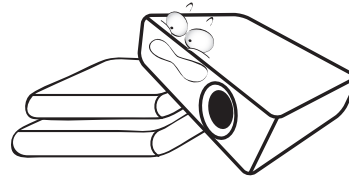

12. Do not stand the projector on end vertically. Doing so may cause the projector to fall over, causing injury or resulting in damage to the projector.

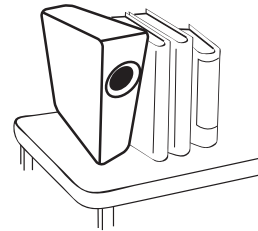

13. Do not step on the projector or place any objects upon it. Besides probable physical damage to the projector, doing so may result in accidents and possible injury.

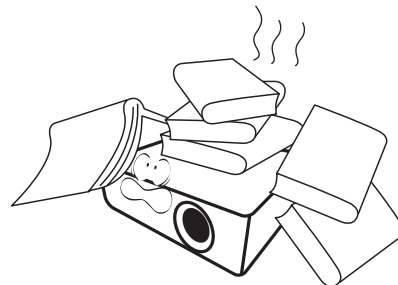

14. When the projector is under operation, you may sense some heated air and odor from its ventilation grill. It is a normal phenomenon and not a product defect.

15. Do not place liquids near or on the projector. Liquids spilled into the projector may cause it to fail. If the projector does become wet, disconnect it from the power supply's power outlet and call BenQ to have the projector serviced.

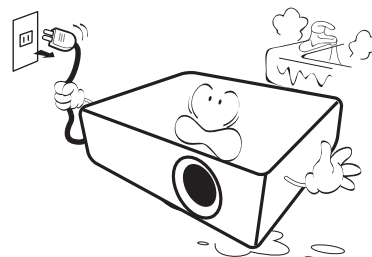

16. This product is capable of displaying inverted images for ceiling mount installation.

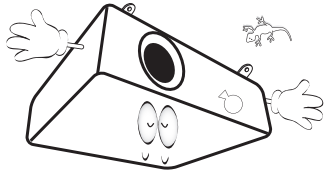

17. This apparatus must be earthed.

18. Do not place this projector in any of the following environments.

- Space that is poorly ventilated or confined. Allow at least 50 cm clearance from walls and free flow of air around the projector.
- Locations where temperatures may become excessively high, such as the inside of a car with all windows rolled up.
- Locations where excessive humidity, dust, or cigarette smoke may contaminate optical components, shorten the projector's life span and darken the image.

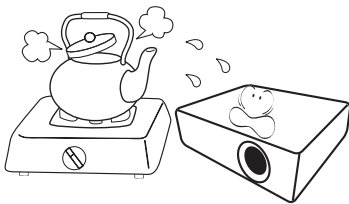

- Locations near fire alarms
- Locations with an ambient temperature above 40°C / 104°F
- Locations where the altitudes are higher than 3000 m (10000 feet).

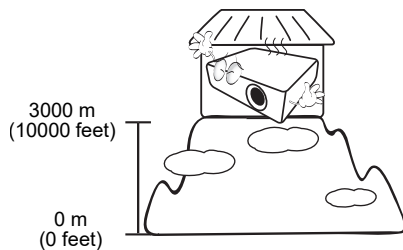

Risk Group 2

1. According to the classification of photobiological safety of light source and light source systems, this product is Risk Group 2, IEC 62471-5:2015.
2. Possibly hazardous optical radiation emitted from this product.
3. Do not stare at operating light source. May be harmful to the eyes.
4. As with any bright source, do not stare into the direct beam.



To avoid damaging the DLP chips, never aim a high-power laser beam into the projection lens.

Introduction

Shipping contents

Carefully unpack and verify that you have all of the items shown below. If any of these items are missing, please contact your place of purchase.

Standard accessories

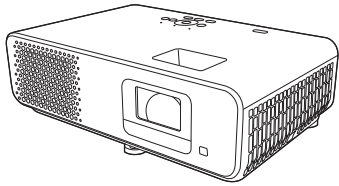

Projector

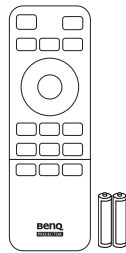

Remote control with batteries

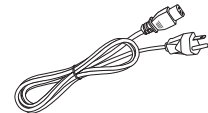

Power cord



Quick start guide



Warranty card*



Regulatory statements



- The supplied accessories will be suitable for your region, and may differ from those illustrated.
- *The warranty card is only supplied in some specific regions. Please consult your dealer for detailed information.

Replacing the remote control batteries

1. Press and slide off the battery cover, as illustrated.
2. Remove the old batteries (if applicable) and install two AAA batteries. Make sure that the positive and negative ends are positioned correctly, as illustrated.
3. Slide the battery cover in until it clicks into place.

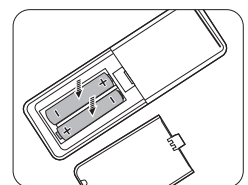
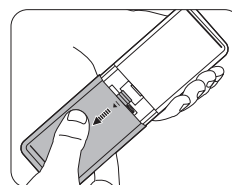



- Avoid leaving the remote control and batteries in an excessive heat or humid environment like the kitchen, bathroom, sauna, sunroom or in a closed car.
- Replace only with the same or equivalent type recommended by the battery manufacturer.
- Dispose of the used batteries according to the manufacturer's instructions and local environment regulations for your region.
- Never throw the batteries into a fire. There may be danger of an explosion.
- If the batteries are dead or if you will not be using the remote control for an extended period of time, remove the batteries to avoid damage to the remote control from possible battery leakage.

Projector exterior view

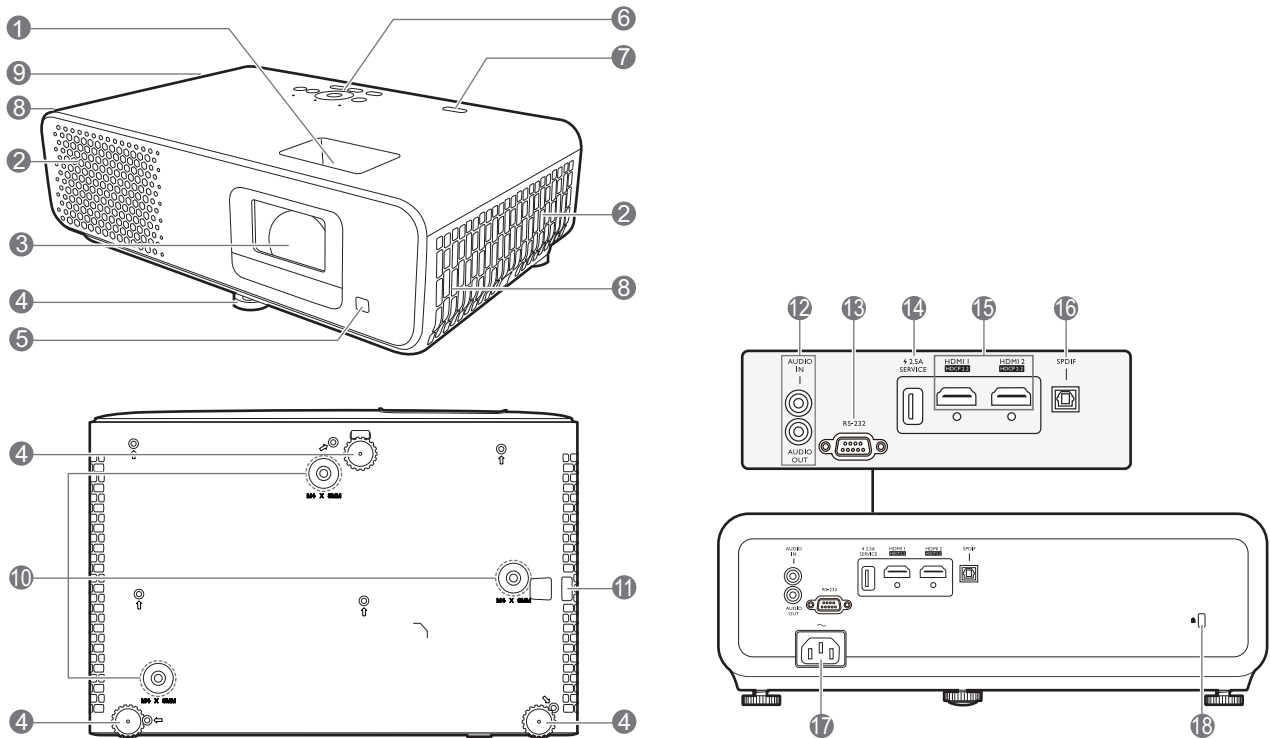

1. Zoom ring/Focus ring
2. Vent (air inlet)
3. Projection lens
4. Adjuster feet
5. IR remote sensor (front)
6. External control panel
See [Controls and functions on page 9](#).
7. IR remote sensor (top)/Ambient light sensor
8. Speakers
9. Vent (air outlet)
10. Ceiling mount holes
11. Anti-theft security bar
12. Audio input jack
(Only works when the projector input source is set to HDMI, and is connected to a DVI device via a DVI cable with a DVI-to-HDMI adapter.)
Audio output jack
13. RS-232 control port
14. USB 2.0 Type-A port (2.5 A power supply, Firmware upgrade)
15. HDMI input ports (Version 2.0b)
16. SPDIF audio output port
17. AC power jack
18. Kensington anti-theft lock slot

Controls and functions

Projector & Remote control

 All the key presses described in this document are available on the remote control or projector.

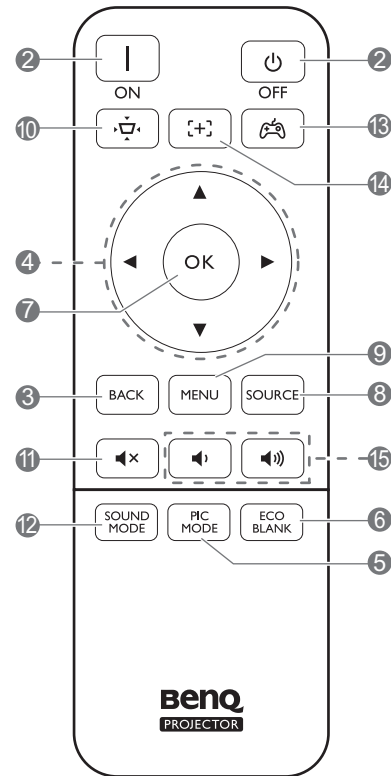
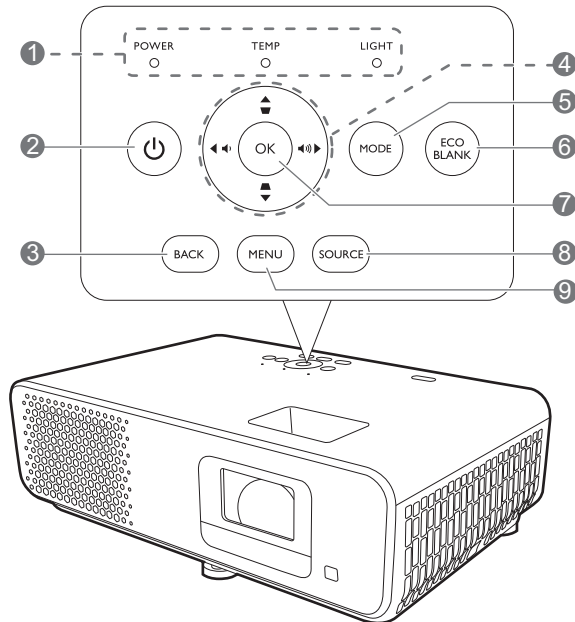

1. **POWER/TEMP/LIGHT** (See [Indicators on page 44.](#))

2. **POWER** (/)

Toggles the projector between standby mode and on.

3. **BACK**

Goes back to previous OSD menu, exits and saves menu settings.

4. **Arrow keys** (▲, ▼, ◀, ▶)

When the On-Screen Display (OSD) menu is activated, these keys are used as directional arrows to select the desired menu items and to make adjustments.

When OSD menu is inactive, workable under CEC-capable sources only.

Keystone keys (▲, ▼) (keypad)

Displays the keystone correction page.

Volume keys (🔊 / 🔊) (keypad)

Decreases or increase the projector volume.

5. **MODE/PIC MODE**

Displays the picture mode menu.

6. **ECO BLANK**

Used to hide the screen picture.

7. **OK**

Confirms the selected On-Screen Display (OSD) menu item.

8. **SOURCE**

Displays the source selection bar.

9. **MENU**

Turns on/off the On-Screen Display (OSD) menu.

10.

Displays the keystone menu. See [Correcting keystone on page 15](#) for details.

11. 

Toggles projector audio between on and off.

12. **SOUND MODE**

Displays the sound mode menu.

13. 

Selects a preset picture and sound mode for games (**Bright/Dark**).

14. 

Press to open/close Auto focus page.

*Available on compatible projectors only.

15.  / 

Decreases or increase the projector volume.

Remote control effective range

The remote control must be held at an angle within 30 degrees perpendicular to the projector's IR remote control sensor(s) to function correctly. The distance between the remote control and the sensor(s) should not exceed 8 meters (~ 26 feet).

Make sure that there are no obstacles between the remote control and the IR sensor(s) on the projector that might obstruct the infra-red beam.

- Operating the projector from the front

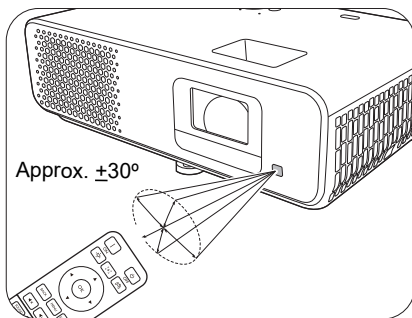

- Operating the projector from the top

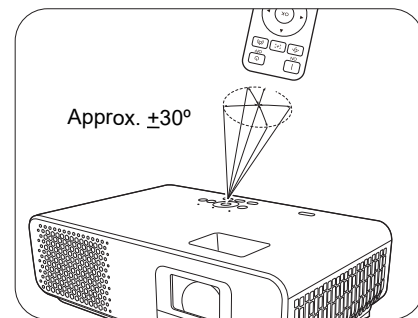

Positioning your projector

Choosing a location

Before choosing an installation location for your projector, take the following factors into consideration:

- Size and position of your screen
- Electrical outlet location
- Location and distance between the projector and the rest of your equipment

You can install your projector in the following ways.

1. Front

Select this location with the projector placed on the table in front of the screen. This is the most common way to position the projector for quick setup and portability.

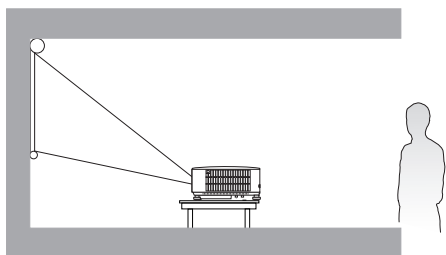

2. Front Ceiling

Select this location with the projector suspended upside-down from the ceiling in front of the screen. Purchase the BenQ Projector Ceiling Mount Kit from your dealer to mount your projector on the ceiling.

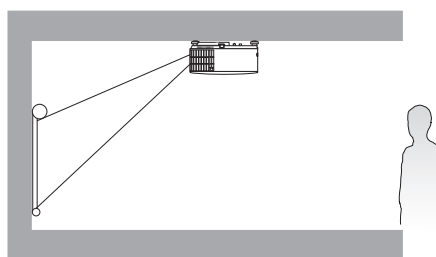

3. Rear

Select this location with the projector placed on the table behind the screen. Note that a special rear projection screen is required.

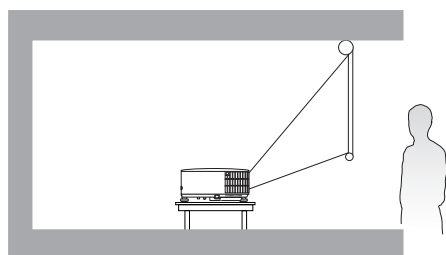

4. Rear Ceiling

Select this location with the projector suspended upside-down from the ceiling behind the screen. Note that a special rear projection screen and the BenQ Projector Ceiling Mount Kit are required for this installation location.

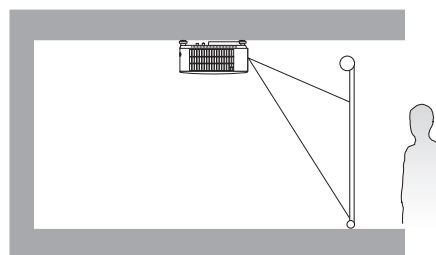

After turning on the projector, go to **Advanced** menu - **Installation** > **Projector Position**, press **OK** and press **◀/▶** to select a setting.

Obtaining a preferred projected image size

The distance from the projector lens to the screen, the zoom setting, and the video format each factors in the projected image size.

Projection dimensions

- The screen aspect ratio is 16:9 and the projected picture is in a 16:9 aspect ratio

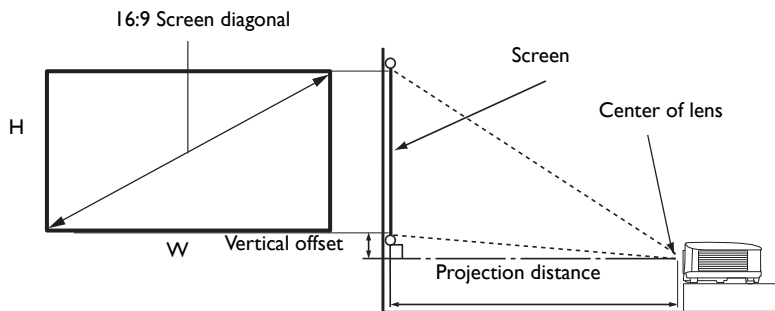

Screen size		Distance from screen (mm)			Vertical offset (Lowest/Highest lens position) (mm)		
Diagonal		H (mm)	W (mm)	Average			
Inch	mm				Min length (max. zoom)	Max length (min. zoom)	
30	762	374	664	458	505	551	10
40	1016	498	886	611	673	735	13
50	1270	623	1107	764	841	919	16
60	1524	747	1328	917	1009	1102	20
70	1778	872	1550	1069	1178	1286	23
80	2032	996	1771	1222	1346	1470	26
90	2286	1121	1992	1375	1514	1654	30
100	2540	1245	2214	1528	1682	1837	33
110	2794	1370	2435	1680	1851	2021	36
120	3048	1494	2657	1833	2019	2205	40
130	3302	1619	2878	1986	2187	2389	43
140	3556	1743	3099	2139	2355	2572	46
150	3810	1868	3321	2291	2524	2756	49
160	4064	1992	3542	2444	2692	2940	53
170	4318	2117	3763	2597	2860	3124	56
180	4572	2241	3985	2750	3028	3307	59
190	4826	2366	4206	2902	3197	3491	63
200	5080	2491	4428	3055	3365	3675	66

For example, if you are using a 120-inch screen, the recommended projection distance is 2019 mm.

If your measured projection distance is 150 cm, the closest match in the "Distance from screen (mm)" column is 1514 mm. Looking across this row shows that a 90" (about 2.3 m) screen is required.



To optimize your projection quality, we suggest doing the projection by referring to the values listed in the non-gray rows.



All measurements are approximate and may vary from the actual sizes.

BenQ recommends that if you intend to permanently install the projector, you should physically test the projection size and distance using the actual projector in situ before you permanently install it, so as to make allowance for this projector's optical characteristics. This will help you determine the exact mounting position so that it best suits your installation location.

Mounting the projector

If you intend to mount your projector, we strongly recommend that you use a proper fitting BenQ projector mounting kit and that you ensure it is securely and safely installed.

If you use a non-BenQ brand projector mounting kit, there is a safety risk that the projector may fall down due to an improper attachment through the use of the wrong gauge or length screws.

Before mounting the projector

- Purchase a BenQ projector mounting kit from the place you purchased your BenQ projector.
- BenQ recommends that you also use a security cable to secure both the base of the mounting bracket and the security bar on the projector. This will perform the secondary role of restraining the projector should its attachment to the mounting bracket become loose.
- Ask your dealer to install the projector for you. Installing the projector on your own may cause it to fall and result in injury.
- Take necessary procedures to prevent the projector from falling off such as during an earthquake.
- The warranty doesn't cover any product damage caused by mounting the projector with a non-BenQ brand projector mounting kit.
- Consider the surrounding temperature where the projector is ceiling mounted. If a heater is used, the temperature around the ceiling may be higher than expected.
- Read the user manual for the mounting kit about the range of torque. Tightening with torque exceeding the recommended range may cause damage to the projector and subsequently falling off.
- Make sure the power outlet is at an accessible height so that you can easily shut down the projector.

Ceiling mount installation diagram

Ceiling mount screw: M4 x 8 mm

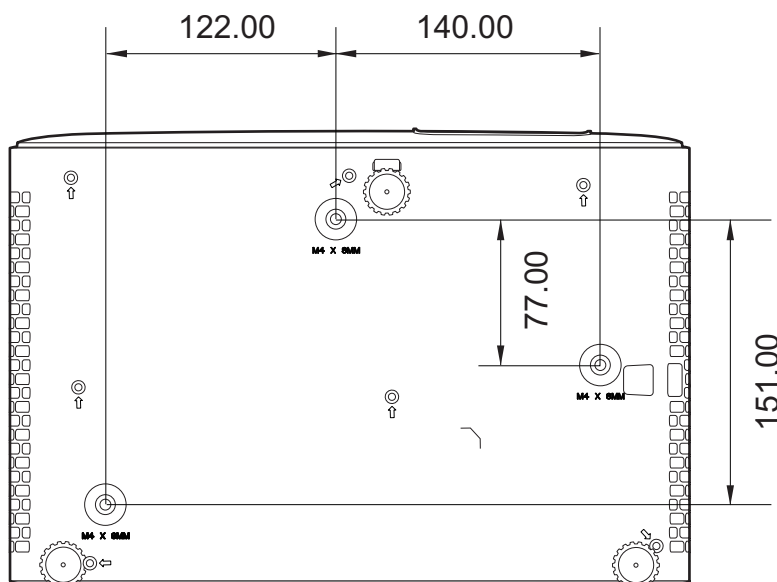

Unit: mm

Adjusting the projected image

Adjusting the projection angle

If the projector is not placed on a flat surface or the screen and the projector are not perpendicular to each other, the projected image becomes trapezoidal. You can screw the adjuster feet to fine-tune the horizontal angle.

To retract the feet, screw the adjuster feet in a reverse direction.

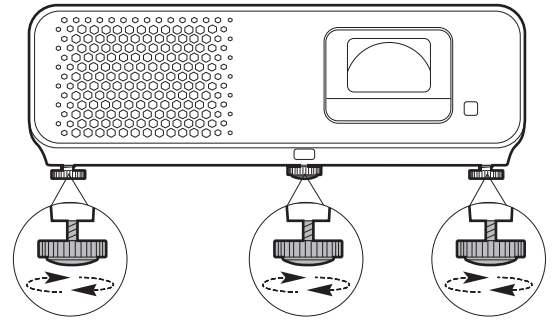

! Do not look into the lens while the light source is on. The strong light from the light source may cause damage to your eyes.

Fine-tuning the image size and clarity

1. Adjust the projected image to the size that you need using the zoom ring.
2. Sharpen the image by rotating the focus ring.

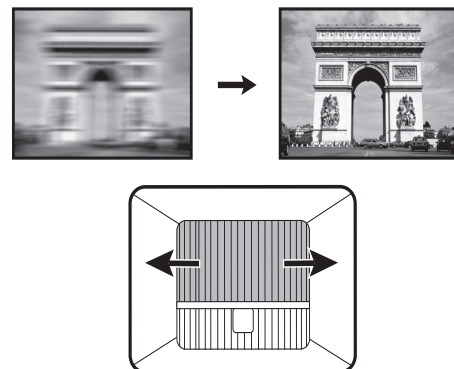
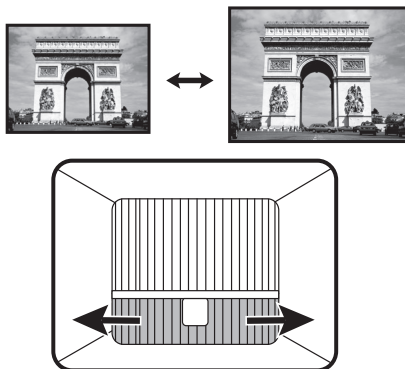

Correcting keystone

Keystoning refers to the situation where the projected image becomes a trapezoid due to angled projection.

To correct the distorted image:

1. Display the **2D Keystone** correction page from the following menus.

- The setup wizard during the projector initial setup
- The **Basic** menu system
- The **Installation** menu of the **Advanced** menu system

2. After the **2D Keystone** correction page appears:

- To correct keystone at the top of the image, use ▼.
- To correct keystone at the bottom of the image, use ▲.
- To correct keystone at the right side of the image, use ◀.
- To correct keystone at the left side of the image, use ▶.
- To reset the keystone values, press **BACK** for 2 seconds.
- To automatically correct the vertical sides of the distorted image, press **OK** for 2 seconds, or enable **Auto Vertical Keystone** in the **Advanced** menu - **Installation** menu.

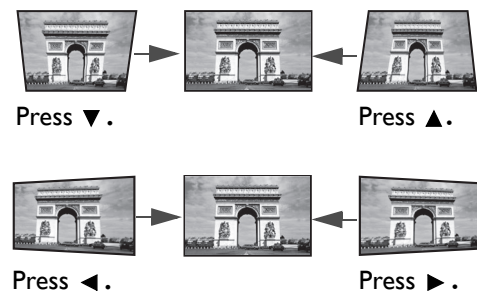

3. When done, press **BACK** to save your changes and exit.

Connection

When connecting a signal source to the projector, be sure to:

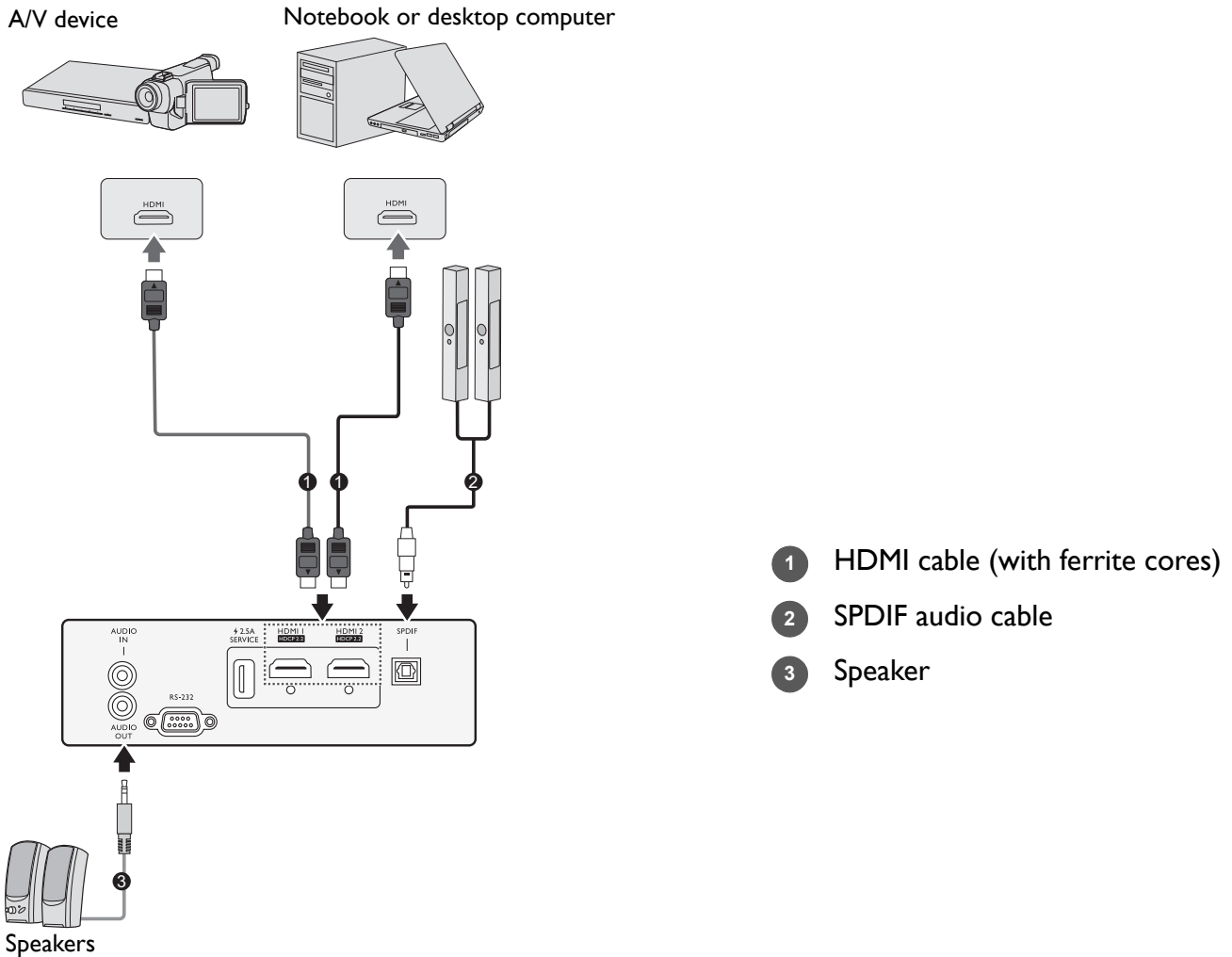

1. Turn all equipment off before making any connections.
2. Use the correct signal cables for each source.
3. Ensure the cables are firmly inserted.



- In the connections above, some cables may not be included with the projector (see [Shipping contents on page 7](#)). They are commercially available from electronics stores.
- The connection illustrations are for reference only. The rear connecting jacks available on the projector vary with each projector model.
- Many notebooks do not turn on their external video ports when connected to a projector. Usually a key combo like FN + function key with a monitor symbol turns the external display on/off. Press FN and the labeled function key simultaneously. Refer to your notebook's documentation to find your notebook's key combination.
- If the selected video image is not displayed after the projector is turned on and the correct video source has been selected, check that the video source device is turned on and operating correctly. Also check that the signal cables have been connected correctly.
- “Audio In” port only works when the projector input source is set to HDMI, and is connected to a DVI device via a DVI cable with a DVI-to-HDMI adapter.





Operation

Starting up the projector

1. Plug the power cord. Turn on the power outlet switch (where fitted). The power indicator on the projector lights orange after power has been applied.
2. Press  on the projector or remote control  to start the projector. The power indicator flashes green and stays green when the projector is on.

The start up procedure takes about 10 seconds. In the later stage of starting up, a start-up logo is projected.

(If necessary) Rotate the focus ring to adjust the image clearness.

3. If this is the first time you turn on the projector, the setup wizard appears to guide you through setting up the projector. If you have already done this, skip this step and move on to the next step.
 - Use the arrow keys (/ / / ) on the projector or remote control to move through the menu items.
 - Use **OK** to confirm the selected menu item.

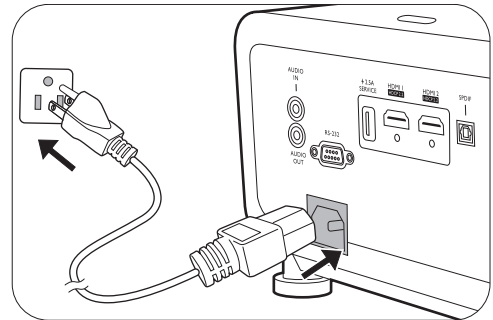

Step 1:

Specify **Projector Position**.

For more information about projector position, see [Choosing a location on page 11](#).

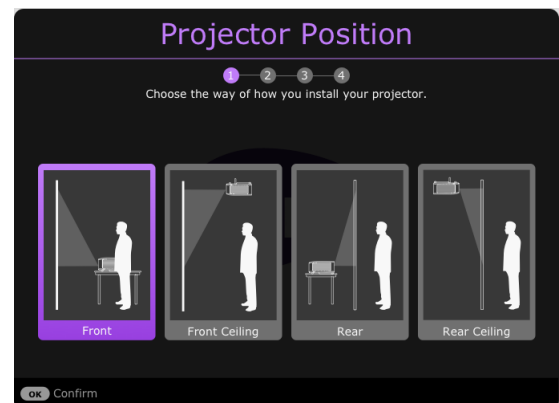

Step 2:

Specify OSD **Language**.

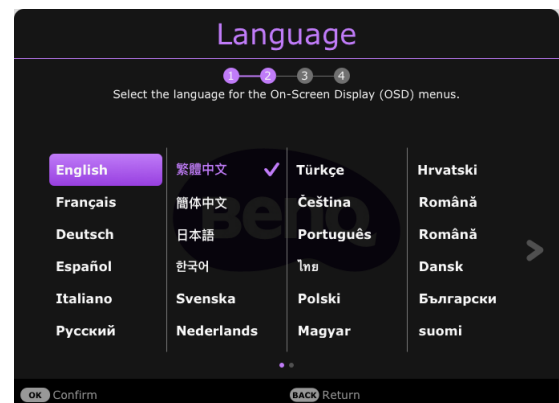

Step 3:

Specify **2D Keystone**, and choose to activate **Auto Vertical Keystone**.

For more information about keystone, see [Correcting keystone on page 15](#).

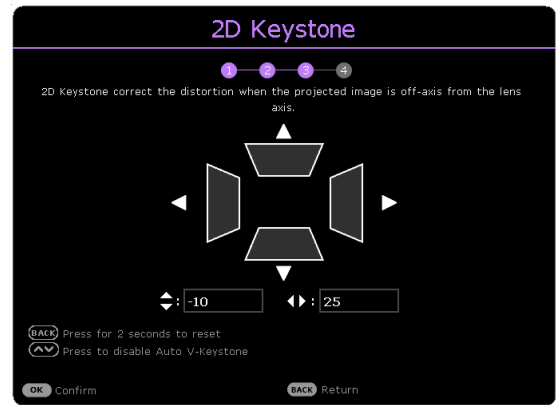

Step 4:

Specify **Game Settings**.

You can select a preferred **Room Setting**, and adjust more image settings in this menu.

See [Game Settings on page 26](#) for details.

Now you've completed the initial setup.

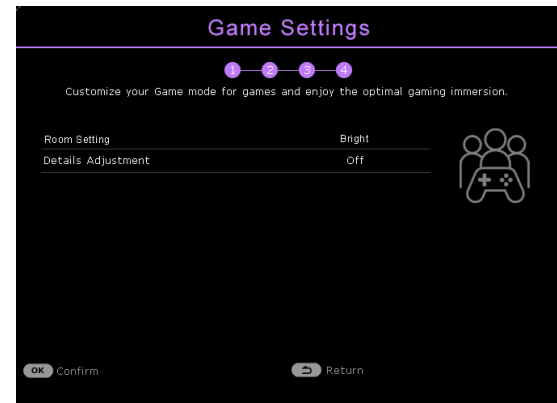

4. If you are prompted for a password, press the arrow keys to enter a 6-digit password. See [Utilizing the password function on page 20](#).
5. Switch all of the connected equipment on.
6. The projector will search for input signals. The current input signal being scanned appears. If the projector does not detect a valid signal, the message “No Signal” will appear until an input signal is found.

You can also press **SOURCE** to select your desired input signal. See [Switching input signal on page 21](#).



- Please use the original accessories (e.g. power cord) to avoid possible dangers such as electric shock and fire.
- If the projector is still hot from previous activity, it will run the cooling fan for approximately 2 seconds before energizing the light source.



- The Setup Wizard screenshots are for reference only and may differ from the actual design.
- If the frequency/resolution of the input signal exceeds the projector's operating range, you will see the message “Out of Range” displayed on the background screen. Please change to an input signal which is compatible with the projector's resolution or set the input signal to a lower setting. See [Timing chart on page 48](#).
- If no signal is detected for 3 minutes, the projector automatically enters saving mode.

Using the menus

The projector is equipped with 2 types of On-Screen Display (OSD) menus for making various adjustments and settings. The **Basic** OSD menu provides primary menu functions while the **Advanced** OSD menu provides full menu functions.

To access the OSD menu, press **MENU** on the projector or remote control.

- Use the arrow keys (▲/▼/◀/▶) on the projector or remote control to move through the menu items.
- Use **OK** on the projector or remote control to confirm the selected menu item.

The first time you use the projector (after finishing the initial setup), press **MENU**, and the **Basic** OSD menu will be displayed.

If you intend to switch from the **Basic** OSD menu to the **Advanced** OSD menu:

1. Go to **Menu Type** and press **OK**.
2. Use ▲/▼ to select **Advanced** and press **OK**. Your projector will switch to the **Advanced** OSD menu.

Likewise, when you wish to switch from the **Advanced** OSD menu to the **Basic** OSD menu, follow the instructions below:

1. Go to **System > Menu Settings > Menu Type** and press **OK**.
2. Use ▲/▼ to select **Basic** and press **OK**. Your projector will switch to the **Basic** OSD menu.

Overview of the Basic OSD menu.

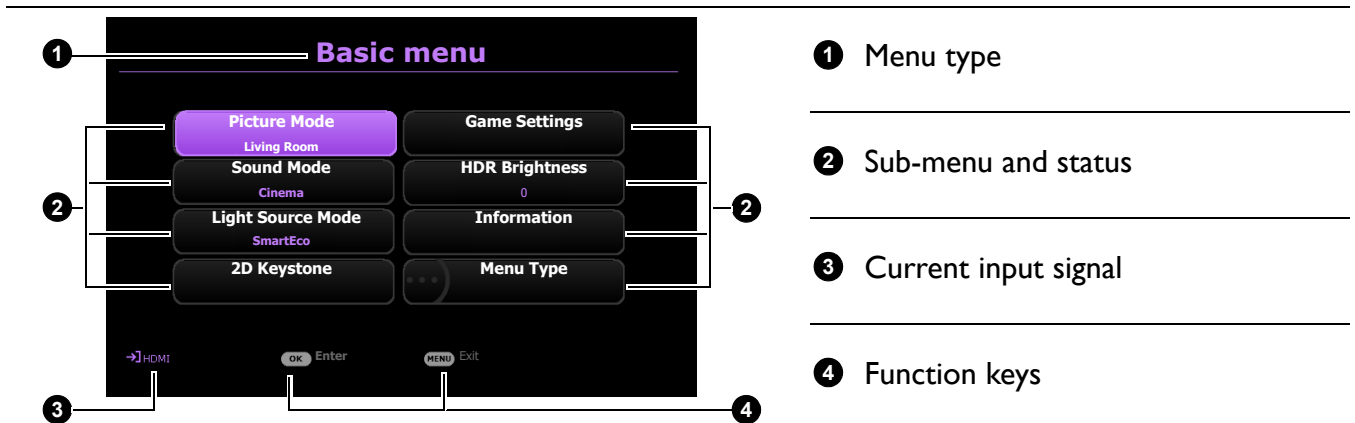

Overview of the Advanced OSD menu.

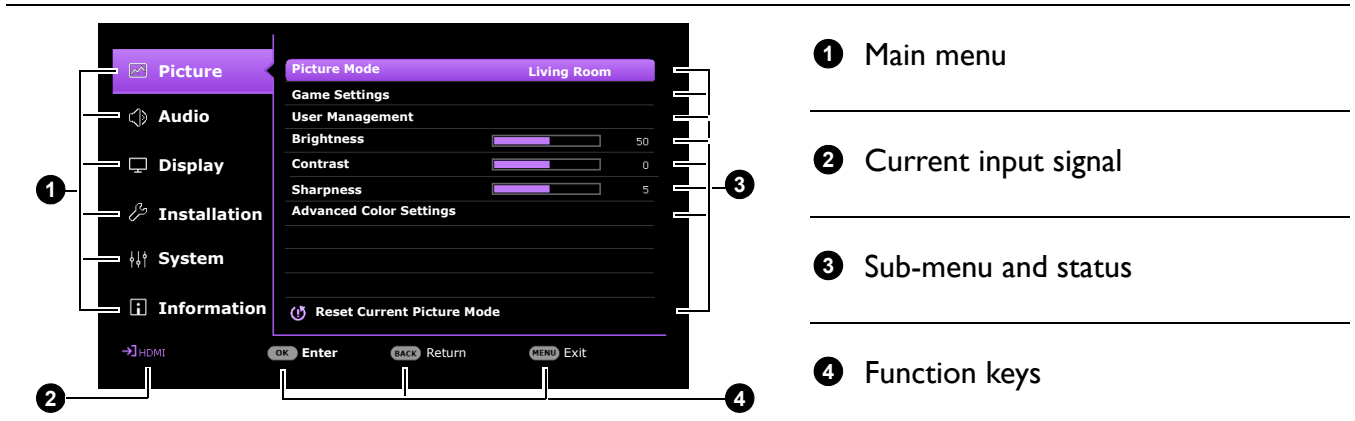

The OSD screenshots are for reference only, and may differ from the actual design.

Securing the projector

Using a security cable lock

The projector has to be installed in a safe place to prevent theft. Otherwise, purchase a security cable to secure the projector. A security bar is located on the right side of the projector. See item 12 on [page 8](#). Insert a security cable to the opening of the security bar and secure it to a nearby fixture or heavy furniture.

You can also purchase a lock, such as the Kensington lock, to secure the projector. There is a Kensington lock slot on the rear side of the projector. See item 18 on [page 8](#). A Kensington security cable lock is usually a combination of key(s) and the lock. Refer to the lock's documentation for finding out how to use it.

Utilizing the password function

Setting a password

1. Go to **Advanced** menu - **System** > **Security Settings**. Press **OK**. The **Security Settings** page appears.
2. Highlight **Change Password** and press **OK**.
3. The four arrow keys (▲, ►, ▼, ◀) respectively represent 4 digits (1, 2, 3, 4). According to the password you desire to set, press the arrow keys to enter six digits for the password.
4. Confirm the new password by re-entering the new password.
5. To activate the **Power On Lock** function, go to **System** > **Security Settings** > **Power On Lock**, press **OK** and ◀/► to select **On**. Input the password again.

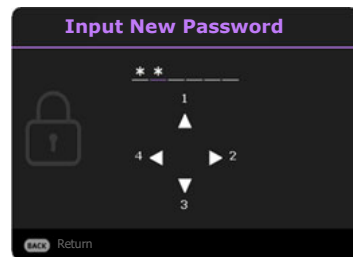

- The digits being input will be displayed as asterisks on-screen. Make a note of your selected password and keep it in a safe place in advance or right after the password is entered so that it is available to you should you ever forget it.
- Once a password has been set and the **Power On Lock** is activated, the projector cannot be used unless the correct password is entered every time the projector is started.

If you forget the password

If you enter the wrong password, the password error message will appear, and the **Input Password** message follows. If you absolutely do not remember the password, you can use the password recall procedure. See [Entering the password recall procedure on page 21](#).

If you enter an incorrect password 5 times in succession, the projector will automatically shut down in a short time.

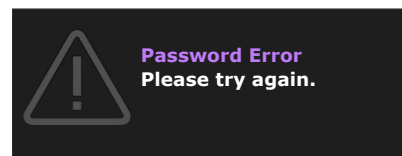

Entering the password recall procedure

1. Press and hold **OK** for 3 seconds. The projector will display a coded number on the screen.
2. Write down the number and turn off your projector.
3. Seek help from the local BenQ service center to decode the number. You may be required to provide proof of purchase documentation to verify that you are an authorized user of the projector.

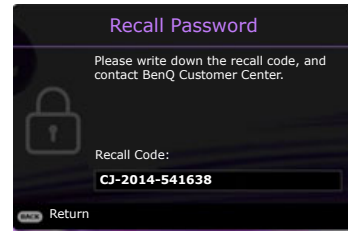

Changing the password

1. Go to **Advanced** menu - **System** > **Security Settings**. Press **OK**. The **Security Settings** page appears.
2. Highlight **Change Password** and press **OK**.
3. Enter the old password.
 - If the password is correct, another message **Input New Password** appears.
 - If the password is incorrect, the password error message will appear, and the message **INPUT CURRENT PASSWORD** appears for your retry. You can press **BACK** to cancel the change or try another password.
4. Enter a new password.
5. Confirm the new password by re-entering the new password.

Disabling the password function

To disable password protection, go to **Advanced** menu - **System** > **Security Settings** > **Power On Lock**, press **OK** and **◀/▶** to select **Off**. The message **Input Password** appears. Enter the current password.

- If the password is correct, the OSD menu returns to the **Security Settings** page. You will not have to enter the password next time turning on the projector.
- If the password is incorrect, the password error message will appear, and the message **INPUT CURRENT PASSWORD** appears for your retry. You can press **BACK** to cancel the change or try another password.



Though the password function is disabled, you need to keep the old password in hand should you ever need to re-activate the password function by entering the old password.

Switching input signal

The projector can be connected to multiple devices at the same time. However, it can only display one full screen at a time. When starting up, the projector automatically searches for the available signals.

Be sure the **Advanced** menu - **Display** > **Auto Source Search** is **On** if you want the projector to automatically search for the signals.

To manually select the source:

1. Press **SOURCE**. A source selection bar appears.
2. Press **▲/▼** until your desired signal is selected and press **OK**.







Once detected, the picture from the selected source will appear. If there is multiple equipment connected to the projector, repeat steps 1-2 to search for another signal.



- The brightness level of the projected image will change accordingly when you switch between different input signals.
- For best display picture results, you should select and use an input signal which outputs at the projector's native resolution. Any other resolutions will be scaled by the projector depending upon the "aspect ratio" setting, which may cause some image distortion or loss of picture clarity. See [Aspect Ratio on page 32](#).

Shutting down the projector

1. Press  on the projector or remote control  and a confirmation message will appear prompting you. If you don't respond in a few seconds, the message will disappear.
2. Press  on the projector or remote control  a second time. The power indicator flashes orange, the projection light source shuts down, and the fans will continue to run for approximately 2 seconds to cool down the projector.
3. Once the cooling process finishes, the power indicator becomes a steady orange and fans stop. Disconnect the power cord from the power outlet.

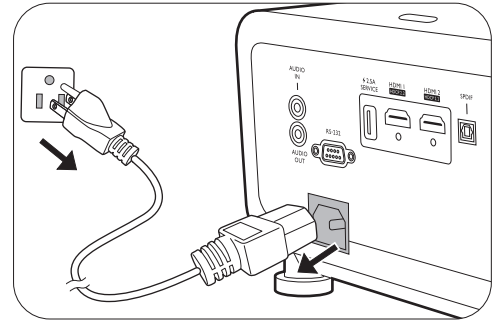

To protect the light source, the projector will not respond to any commands during the cooling process.

Menu operation

Please note that the on-screen display (OSD) menus vary according to the signal type selected and the projector model you are using.

The menu items are available when the projector detects at least one valid signal. If there is no equipment connected to the projector or no signal detected, limited menu items are accessible.

Basic menu

Structure

Menu (Ref. Page)	Options	
Picture Mode (25)	Bright/Living Room/Game/Sports/Cinema/(3D)/(HLG)/(HDR10)/(HDR Game)/User	
Sound Mode (30)	Cinema/Music/Game/Sports/User	
Light Source Mode (28)	Normal/ECO/SmartEco	
2D Keystone (15)	H: -30 – +30 V: -30 – +30	
Game Settings (26)	Room Setting	Bright/Dark
	Details Adjustment	Off/On
HDR Brightness (28)	-2/-1/0/1/2	
Information (41)	Detected Resolution	
	Source	
	Picture Mode	
	Light Source Mode	
	3D Format	
	Color System	
	Dynamic Range	
	Light Source Usage Time	
	Firmware Version	
	Service Code	
Menu Type (39)	Basic/Advanced	

Advanced menu

I. Main menu: **Picture**

Structure

Menu		Options
Picture Mode		Bright/Living Room/Game/Sports/Cinema/3D/HDR10/HDR Game/HLG/User
Game Settings	Room Setting	Bright/Dark
	Details Adjustment	Off/On
User Management	Load Settings From	Living Room/Game/Sports/Cinema
	Rename User Mode	
Brightness		0–100
Contrast		0–100
Sharpness		0–15
Gamma Selection		1.8/2.0/2.1/2.2/2.3/2.4/2.5/2.6/BenQ
		Native (for Bright picture mode)
		Normal/Cool/Warm (for the rest picture modes)
Advanced Color Settings	Color Temperature Tuning	R Gain/ G Gain/ B Gain
		0–200
		R Offset/ G Offset/ B Offset
		0–511
	Color Management	R/G/B/C/M/Y
	White Balance	R Gain/G Gain/B Gain
Light Source Mode		Normal/ECO/SmartEco
HDR Brightness		-2/-1/0/1/2
Noise Reduction		0 – 31
Reset Current Picture Mode		Reset/Cancel

Function descriptions

Menu	Descriptions
Picture Mode	<p>The projector is preset with several predefined picture modes so that you can choose one to suit your operating environment and input signal picture type.</p>
	<ul style="list-style-type: none">• Bright
	<p>Maximizes the brightness of the projected image. This mode is suitable for environments where extra-high brightness is required, such as using the projector in well lit rooms.</p>
	<ul style="list-style-type: none">• Living Room
	<p>With well-saturated color, fine-tuned sharpness, and a higher brightness level, Living Room mode is suitable for TV streaming in rooms where there is a small amount of ambient light, e.g. your living room.</p>
	<ul style="list-style-type: none">• Game
	<p>With optimal Audio-Visual settings for 2 types of games: Bright games and Dark games to give a perfect gameplay experience at home.</p>
	<ul style="list-style-type: none">• Sports
	<p>With well-saturated colors and higher brightness level, this mode is best for watching sporting events in a bright room.</p>
	<ul style="list-style-type: none">• Cinema
<p>With accurate color and deepest contrast at lower brightness level, Cinema mode is suitable for playing movies in a environment with a bit of ambient light, as if in a commercial cinema.</p>	
<ul style="list-style-type: none">• 3D	
<p>Optimized to bring up 3D effects when watching 3D contents.</p>	
	
<p>This mode is only available when 3D function is enabled.</p>	
<ul style="list-style-type: none">• HDR10/HDR Game	
<p>Delivers High Dynamic Range effects with higher contrasts of brightness and colors for HDR Blu-ray movies or HDR games. After auto-detecting metadata or EOTF info from HDR contents, HDR10 and HDR Game are available for selection. HDR10 is best for displaying Blu-ray movies, while HDR Game is used to activate Game Settings menu for HDR gameplay.</p>	
<ul style="list-style-type: none">• HLG	
<p>Delivers High Dynamic Range effects with higher contrasts of brightness and colors. Picture Mode will be switched to HLG automatically while detecting metadata or EOTF info from HLG streaming contents.</p>	
<ul style="list-style-type: none">• User	
<p>Recalls the settings customized based on the current available picture modes. See User Management on page 26.</p>	

Game Settings menu is only available when **Picture Mode** is set at **Game** or **HDR Game**.

- **Room Setting**

You can select a preferred mode from among **Bright** or **Dark**. When one of the modes is set, all the functions provided under **Game Settings** menu will be available for adjustments.

Game Settings

- **Bright**: Provides enhanced vivid and brilliant colors, as well as tuned-sound in high frequencies for the game juice effect.
- **Dark**: Provides CinematicColor and powerful Cinema sound as if in a film-like game world.

- **Details Adjustment**

Adjusts the level of detail clarity. When turned On, more details will be shown but with lower black performance.

There is one user-definable mode if the current available picture modes are not suitable for your need. You can use one of the picture modes (except the **User**) as a starting point and customize the settings.

- **Load Settings From**

1. Go to **Picture > Picture Mode**.
2. Press ◀/▶ to select **User**.
3. Press ▼ to highlight **User Management**, and press **OK**. The **User Management** page is displayed.
4. Select **Load Settings From** and press **OK**.
5. Press ▼/▲ to select a picture mode that is closest to your need.
6. Press **OK** and **BACK** to return to the **Picture** menu.
7. Press ▼ to select the sub-menu items you want to change and adjust the values with ◀/▶. The adjustments define the selected user mode.

User Management

- **Rename User Mode**

Select to rename the customized picture mode (**User**). The new name can be up to 9 characters including English letters (A-Z, a-z), digits (0-9), and space ().

1. Go to **Picture > Picture Mode**.
2. Press ◀/▶ to select **User**.
3. Press ▼ to highlight **User Management**, and press **OK**. The **User Management** page is displayed.
4. Press ▼ to highlight **Rename User Mode** and press **OK**. The **Rename User Mode** page is displayed.
5. Use ▲/▶/▼/◀, and **OK** to set desired characters.
6. When done, press **BACK** to save the changes and exit.

Brightness

The higher the value, the brighter the image. Adjust this control so the black areas of the image appear just as black and that detail in the dark areas is visible.

Contrast

The higher the value, the greater the contrast. Use this to set the peak white level after you have previously adjusted the Brightness setting to suit your selected input and viewing environment.

Sharpness

The higher the value, the sharper the picture becomes.

• Gamma Selection

Gamma refers to the relationship between input source and picture brightness.

- **1.8/2.0/2.1/BenQ**: Select these values according to your preference.
- **2.2/2.3**: Increases the average brightness of the picture. Best for a lit environment, meeting room or family room.
- **2.4/2.5**: Best for viewing movies in a dark environment.
- **2.6**: Best for viewing movies which are mostly composed of dark scenes.

High Brightness
Low Contrast

Low Brightness
High Contrast



1.8 2.0 2.1 2.2 2.3 2.4 2.5 2.6 BenQ

Advanced Color Settings

• Color Temperature Tuning

There are several preset color temperature settings available. The available settings may vary according to the signal type selected.

When **Bright** is selected for **Picture Mode**, the color temperature switches to **Native**, and cannot be changed.

- **Native**: With the light source's original color temperature and higher brightness, this setting is suitable for environments where high brightness is required, such as projecting pictures in well lit rooms.
 - **Normal**: Maintains normal colorings for white.
 - **Cool**: Makes images appear bluish white.
 - **Warm**: Makes images appear reddish white.
-

You can also set a preferred color temperature by adjusting the following options.

- **R Gain/G Gain/B Gain:** Adjusts the contrast levels of Red, Green, and Blue.
- **R Offset/G Offset/B Offset:** Adjusts the brightness levels of Red, Green, and Blue.

- **Color Management**

The Color Management provides six sets (RGBCMY) of colors to be adjusted. When you select each color, you can independently adjust its range and saturation according to your preference.

To make adjustments, press the ▲/▼ arrows to highlight an independent color from among Red (R), Green (G), Blue (B), Cyan (C), Magenta (M), or Yellow (Y), and press **OK**. The following menu items are displayed for your choice.

- **Hue:** Increase in the range will include colors consisted of more proportions of its two adjacent colors. Please refer to the illustration for how the colors relate to each other.

For example, if you select Red and set its range at 0, only pure red in the projected picture will be selected. Increasing its range will include red close to yellow and red close to magenta.

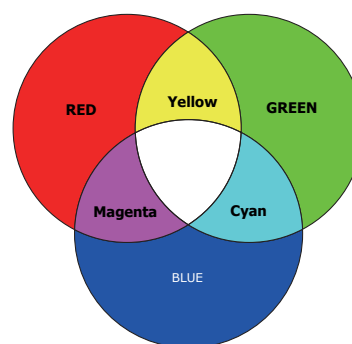

- **Saturation:** Adjusts the values to your preference. Every adjustment made will reflect to the image immediately. For example, if you select Red and set its value at 0, only the saturation of pure red will be affected.
- **Gain:** Adjusts the values to your preference. The contrast level of the primary color you select will be affected. Every adjustment made will reflect to the image immediately.

If you selected **White Balance (W)**, you can adjust the contrast levels of Red, Green, and Blue by selecting **R Gain**, **G Gain**, and **B Gain**.



Saturation is the amount of that color in a video picture. Lower settings produce less saturated colors; a setting of “0” removes that color from the image entirely. If the saturation is too high, that color will be overpowering and unrealistic.

- **Light Source Mode**

Selects a suitable light source power from among the provided modes. See [Extending light source life on page 43](#).

- **HDR Brightness**

The projector can automatically adjust the brightness levels of your image according to the input source. You can also manually select a brightness level to display better picture quality. When the value is higher, the image becomes brighter; when the value is lower, the image becomes darker.

- **Noise Reduction**

Reduces electrical image noise caused by different media players.

Advanced Color Settings (Continued)

Reset Current Picture Mode

Returns all of the adjustments you've made for the selected **Picture Mode** (including the preset mode, **User**) to the factory preset values.

1. Press **OK**. The confirmation message is displayed.
2. Use ◀/▶ to select **Reset** and press **OK**. The current picture mode returns to the factory preset settings.



The following settings will still remain: **Picture Mode, Game Settings**.

2. Main menu: **Audio**

Structure

Menu	Options
Sound Mode	Cinema/Music/Game/Sports/User
User Sound EQ	100Hz/300Hz/ 1kHz/3kHz/10kHz -10 – +10
Audio Output	treVolo/S/PDIF/3.5mm Jack
Audio Output Format	LPCM/RAW
Mute	Off/On
Volume	0 – 20
L/R Switch	Off/On
Power On/Off	Off/On
Ring Tone	Off/On
Reset Audio	Reset/Cancel

Function descriptions

Menu	Descriptions
Sound Mode	<p>This function utilizes treVolo and Bongiovi DPS (Digital Power Station) Technology, which incorporates its patented algorithms with 120 calibration points that optimizes any audio signal in real time to add depth, clarity, definition, presence and enhanced stereo field imaging for more immersive audio experience. The following preset sounds are available: Cinema, Music, Game, Sports, and User. When Room Setting in the Advanced menu - Picture > Game Settings is activated, Dark/Bright deploys Game sound mode.</p> <p>The User mode allows you to personalize the sound settings. When selecting the User mode, you may make manual adjustments with the User Sound EQ function.</p> <p>If the Mute function is activated, adjusting Sound Mode will turn off the Mute function.</p>
User Sound EQ	<p>Select desired frequency bands (100 Hz, 300 Hz, 1k Hz, 3k Hz, and 10k Hz) to adjust the levels according to your preference. The settings made here define the User mode.</p>
Audio Output	<p>Selects the audio output from internal or external speakers.</p> <p>To enjoy S/PDIF digital sound effect, make sure the SPDIF connector on the projector is connecting to a compatible audio system.</p>
Audio Output Format	<p>Selects LPCM or RAW signal for S/PDIF audio output of the projector.</p> <p>To enjoy 2.0/5.1/7.1 channel audio out, please check the audio format from your player and external speakers.</p>
Mute	<p>Select On to temporarily turn off the projector's internal speaker or the volume being output from the audio output jack.</p> <p>To restore the audio, select Off.</p>

Volume	Adjusts the volume level of the projector's internal speaker or the volume being output from the audio output jack. If the Mute function is activated, adjusting Volume will turn off the Mute function.
L/R Switch	The left and right audio channels will automatically swap when selecting On .
Power On/Off Ring Tone	Sets the ring tone for the projector On or Off . The Power On/Off Ring Tone can only be adjusted here. Setting the sound mute or adjusting the sound level do not affect the Power On/Off Ring Tone .
Reset Audio	Returns all of the adjustments you've done under the Audio menu to the factory preset values.

3. Main menu: **Display**

Structure

Menu		Options
Aspect Ratio		Auto/4:3/16:9
Auto Source Search		Off/On
Source Rename		HDMI-1/HDMI-2
3D	3D Mode	Auto/Frame Sequential/Frame Packing/Top Bottom/Side by Side/Off
	3D Sync Invert	Disable/Invert
HDMI Settings	HDMI Format	Auto/Limited/Full
	HDMI Equalizer	HDMI-1/HDMI-2
	HDMI EDID	HDMI-1/HDMI-2
	Electronics Control	Auto/1/2/3/4/5
	Enhanced/Standard	Off/On
	Power On Link	Off/From Device
Power Off Link		Off/From Projector
Reset Display		Reset/Cancel

Function descriptions

Menu	Descriptions
	<p>There are several options to set the image's aspect ratio depending on your input signal source.</p> <p>This image adjustment might impact latency in Game mode. We suggest setting Aspect Ratio to Auto to enjoy low latency gaming.</p>
Aspect Ratio	<p></p> <p>If no source is detected, this function is not available, and the Screen Fill is set to 4:3 or 1:1.</p> <ul style="list-style-type: none"> • Auto Scales an image proportionally to fit the projector's native resolution in its horizontal or vertical width. • 4:3 Scales an image so that it is displayed in the center of the screen with a 4:3 aspect ratio. • 16:9 Scales an image so that it is displayed in the center of the screen with a 16:9 aspect ratio.
Auto Source Search	Allows the projector to automatically search for a signal.

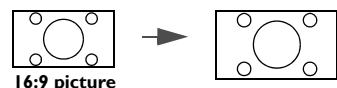
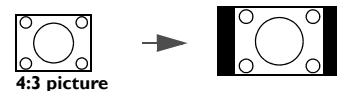
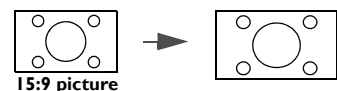

Renames the current input source to your desired name.

On the **Source Rename** page:

Source Rename

1. Press **OK** to display the on-screen keyboard.
2. Press **▲/▼/◀/▶** to select each desired digit/letter, and press **OK** to confirm each input.
3. Repeat the step above and when done, press **BACK** and **▼** to highlight **Commit**.
4. Press **OK** and the source name changes.

This projector supports playing three-dimensional (3D) content transferred through your 3D-compatible video devices and contents, such as PlayStation consoles (with 3D game discs), 3D Blu-ray players (with 3D Blu-ray discs), and so on. After you have connected the 3D video devices to the projector, wear the BenQ 3D glasses and make sure the power is on to view 3D contents.

When watching 3D contents:

- The image may seem misplaced; however, this is not a product malfunction.
- Take appropriate breaks when watching 3D contents.
- Stop watching 3D contents if you feel fatigue or discomfort.
- Keep a distance from the screen of about three times the effective height of the screen.
- Children and people with a history of oversensitivity to light, heart problems, or any other existing medical conditions should be refrained from watching 3D contents.
- The image may seem reddish, greenish, or bluish without wearing 3D glasses. However, you will not notice any color bias when watching 3D contents with 3D glasses.
- The 4K source will not be displayed.

3D

• 3D Mode

The default setting is **Auto** and the projector automatically chooses an appropriate 3D format when detecting 3D contents. If the projector cannot recognize the 3D format, manually choose a 3D mode according to your preference.

When this function is enabled:

- The brightness level of the projected image decreases.
- The **Picture Mode** cannot be adjusted.
- The **2D Keystone** can only be adjusted within limited degrees.

• 3D Sync Invert

When your 3D image is distorted, enable this function to switch between the image for the left eye and the right eye for more comfortable 3D viewing experience.

- **HDMI Format**

Selects a suitable RGB color range to correct the color accuracy.

- **Auto:** Automatically selects a suitable color range for the incoming HDMI signal.
- **Limited:** Utilizes the Limited range RGB 16-235.
- **Full:** Utilizes the Full range RGB 0-255.

- **HDMI Equalizer**

Sets a suitable value to maintain the HDMI picture quality in long distance data transmission.

- **HDMI EDID**

Switches between **Enhanced** for HDMI 2.0 EDID and **Standard** for HDMI 1.4 EDID. Selecting **Standard** which supports up to 1080p 60Hz may solve abnormal display issues with some old players.

- **Electronics Control**

When you enable this function and connect an HDMI CEC-compatible device to your projector with an HDMI cable, turning on the HDMI CEC compatible device automatically turns on the projector, while turning off the projector automatically turns off the HDMI CEC compatible device.

- **Power On Link/Power Off Link**

When you connect an HDMI CEC-compatible device to your projector with an HDMI cable, you can set the behavior of powering on/off between the device and the projector.

Power On Link > From Device	When the connected device is turned on, the projector will be activated, too.
Power Off Link > From Projector	When the projector is turned off, the connected device will be shut down, too.

HDMI Settings

Reset Display

Returns all the settings in the **Display** main menu to the factory default values.

4. Main menu: Installation

Structure

Menu	Options
Projector Position	Front/Front Ceiling/Rear/Rear Ceiling
2D Keystone	H: -30 – +30
	V: -30 – +30
Auto Vertical Keystone	Off/On
LumiExpert	LumiExpert Off/On
	LumiExpert Level -1 – +1
	Manual Calibration Manual Calibration Status/Calibrate/Reset Manual Calibration
Test Pattern	Off/On
High Altitude Mode	Off/On
Baud Rate	9600/14400/19200/38400/57600/115200
Screen Fill	16:9/4:3/1:1
Digital Lens Shift	

Function descriptions

Menu	Descriptions
Projector Position	The projector can be installed on a ceiling or behind a screen, or with one or more mirrors. See Choosing a location on page 11 for details.
2D Keystone	See Correcting keystone on page 15 for details. This image adjustment might impact latency in Game mode. We suggest setting the 2D Keystone values to 0 to enjoy low latency gaming.
Auto Vertical Keystone	Automatically corrects the vertical keystone of the projected image. This image adjustment might impact latency in Game mode. We suggest turning Auto Vertical Keystone off to enjoy low latency gaming.

-
- **LumiExpert:** When this function is enabled, the projector actively detects the ambient light conditions and automatically adjusts balanced visual brightness to create an optimum viewing experience.



This function is not available in Test Pattern, or when the **Picture Mode** is **HDR10**, **HDR Game** or **HLG**. It is also not available when there is no source detected.

- **LumiExpert Level:** Adjusts the gamma offset.

LumiExpert



This function is not available when **LumiExpert** is Off.

- **Manual Calibration:** According to the ambient brightness, you can do the calibration manually.
 - **Manual Calibration Status:** Shows the status of manual calibration.
 - **Calibrate:** Enact this item to start the calibration process.
 - **Reset Manual Calibration:** Resets the gamma offset to factory preset values.

Test Pattern

Adjusts the image size and focus and check that the projected image is free from distortion.

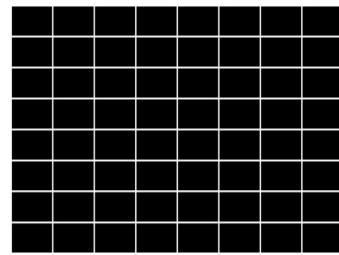

High Altitude Mode

We recommend you use the **High Altitude Mode** when your environment is between 1500 m–3000 m above sea level, and ambient temperature is between 0°C–30°C.

Operation under "**High Altitude Mode**" may cause a higher decibel operating noise level because of increased fan speed necessary to improve overall system cooling and performance.

If you use this projector under other extreme conditions excluding the above, it may display auto shut-down symptoms, which is designed to protect your projector from over-heating. In cases like this, you should switch to High Altitude mode to solve these symptoms. However, this is not to state that this projector can operate under any and all harsh or extreme conditions.



Do not use the **High Altitude Mode** if your altitude is between 0 m and 1500 m and ambient temperature is between 0°C and 35°C. The projector will be over cooled, if you turn the mode on under such a condition.

Baud Rate

Selects a baud rate that is identical with your computer's so that you can connect the projector with a suitable RS-232 cable and update or download the projector's firmware. This function is intended for qualified service personnel.

Select user preferred aspect ratio, see [Screen Fill on page 35](#) for details.

Screen Fill



The EDID change is only available on HDMI.

Use ◀/▶ to horizontally shift the projected image.

Digital Lens Shift



- This is only available with HDMI input source.
 - This function is not available in **3D** mode or when **Screen Fill** is set to **16:9**.
 - When **Screen Fill** is adjusted, **Digital Lens Shift** resets to 0.
-

5. Main menu: **System**

Structure

Menu		Options
Language		English/Français/Deutsch/Italiano/Español/ Русский/繁體中文/简体中文/日本語/한국어/ Svenska/Nederlands/Türkçe/Čeština/ Português/ភាសាខ្មែរ/Polski/Magyar/Hrvatski/ Română/Norsk/Dansk/Български/Suomi/ Bhs Ind/Ελληνικά/العربية/हिन्दी
Background Settings	Background	BenQ/Gray/Black/Blue/Purple
	Splash Screen	BenQ/Black/Blue
Menu Settings	Menu Type	Basic/Advanced
	Menu Display Time	5 sec/10 sec/20 sec/30 sec/Always
	Menu Position	Center/Top-Left/Top-Right/ Bottom-Right/Bottom-Left
Light Source Information	Light Source Usage Time	
	Normal Mode	
	ECO Mode	
	SmartEco Mode	
	Equivalent Light Hours	
	Refer to UM for detailed formula	
	Reset Light Timer	Reset/Cancel
Operation Settings	Reminder Message	Off/On
	LED Indicator	Off/On
	Power On/Off Settings	Direct Power On Off/On
		Auto Power Off Disable/3 min/10 min/15 min/ 20 min/25 min/30 min
Security Settings	Panel Key Lock	Off/On Yes/No
	Change Password	
	Power On Lock	Off/On
Factory Default		Reset/Cancel
Reset System		Reset/Cancel

Function descriptions

Menu	Descriptions
Language	Sets the language for the On-Screen Display (OSD) menus.
Background Settings	<ul style="list-style-type: none"> • Background <p>Allows you to select the background color for the projector.</p> <ul style="list-style-type: none"> • Splash Screen <p>Allows you to select which logo screen will be displayed during projector start-up.</p>
Menu Settings	<ul style="list-style-type: none"> • Menu Type <p>Sets the OSD menu type according to your needs.</p> <ul style="list-style-type: none"> • Menu Display Time <p>Sets the length of time the OSD will remain active after your last key press.</p> <ul style="list-style-type: none"> • Menu Position <p>Sets the On-Screen Display (OSD) menu position.</p>
Light Source Information	<p>This menu page displays the following information:</p> <ul style="list-style-type: none"> • Light Source Usage Time <ul style="list-style-type: none"> • Light hours used under Normal Mode, ECO Mode, and SmartEco Mode. • Equivalent Light Hours. <p>For details about how to calculate the hours, see Getting to know the light hour on page 43.</p> <ul style="list-style-type: none"> • Reset Light Timer: Reset the light timer after installing a new light.
Operation Settings	<ul style="list-style-type: none"> • Reminder Message <p>Sets the reminder messages on or off.</p> <ul style="list-style-type: none"> • LED Indicator <p>You can turn off the LED warning lights. This is to avoid any light disturbance when viewing images in a dark room.</p> <ul style="list-style-type: none"> • Power On/Off Settings: <ul style="list-style-type: none"> • Direct Power On: Allows the projector to turn on automatically once the power is fed through the power cord. • Auto Power Off: Allows the projector to turn off automatically if no input signal is detected after a set period of time to prevent unnecessary waste of light source life.

- **Panel Key Lock:**

With the control keys on the projector locked, you can prevent your projector settings from being changed accidentally (by children, for example). When the **Panel Key Lock** is on, no control keys on the projector will operate except  **POWER**.

Security Settings

To release panel key lock, press and hold  (the right key) on the projector or remote control for 3 seconds.



If you turn off the projector without disabling panel key lock, the projector will still be in locked status the next time it is turned on.

- **Change Password/Power On Lock**

See [Utilizing the password function on page 20](#).

Returns all settings to the factory preset values.

Factory Default



The following settings will still remain: **Projector Position, 2D Keystone, Auto Vertical Keystone, High Altitude Mode, Baud Rate, Light Source Information, Security Settings, Screen Fill, Digital Lens Shift.**

Returns all the settings in the **System** main menu to the factory default values.

Reset System



The following settings will still remain: **Light Source Information, Security Settings.**

6. Main menu: Information

Structure

Menu	Options
Detected Resolution	
Source	
Picture Mode	
Light Source Mode	
3D Format	
Color System	
Dynamic Range	
Light Source Usage Time	
Firmware Version	
Service Code	

Function descriptions

Menu	Descriptions
Detected Resolution	Shows the native resolution of the input signal.
Source	Shows the current signal source.
Picture Mode	Shows the selected mode in the Picture menu.
Light Source Mode	Shows the used light source mode.
	Displays the current 3D mode.
3D Format	 3D Format is only available when 3D is enabled.
Color System	Shows the input system format.
Dynamic Range	Shows the picture dynamic range, e.g. SDR, HDR10, HLG, etc.
Light Source Usage Time	Shows the number of hours the light has been used.
Firmware Version	Shows the firmware version of your projector.
Service Code	Shows the projector's serial number.

Maintenance

Care of the projector

Cleaning the lens

Clean the lens whenever you notice dirt or dust on the surface. Please be sure to turn off the projector and let it cool down completely before cleaning the lens.

- Use a canister of compressed air to remove dust.
- If there is dirt or smears, use lens-cleaning paper or moisten a soft cloth with lens cleaner and gently wipe the lens surface.
- Never use any type of abrasive pad, alkaline/acid cleaner, scouring powder, or volatile solvent, such as alcohol, benzene, thinner or insecticide. Using such materials or maintaining prolonged contact with rubber or vinyl materials may result in damage to the projector surface and cabinet material.

Cleaning the projector case

Before you clean the case, turn the projector off using the proper shutdown procedure as described in [Shutting down the projector on page 22](#) and unplug the power cord.

- To remove dirt or dust, wipe the case with a soft, lint-free cloth.
- To remove stubborn dirt or stains, moisten a soft cloth with water and a neutral pH detergent. Then wipe the case.



Never use wax, alcohol, benzene, thinner or other chemical detergents. These can damage the case.

Storing the projector

If you need to store the projector for an extended time, please follow the instructions below:

- Make sure the temperature and humidity of the storage area are within the recommended range for the projector. Please refer to [Specifications on page 46](#) or consult your dealer about the range.
- Retract the adjuster feet.
- Remove the battery from the remote control.
- Pack the projector in its original packing or equivalent.

Transporting the projector

It is recommended that you ship the projector with its original packing or equivalent.

Light source information

Getting to know the light hour

When the projector is in operation, the duration (in hours) of light source usage is automatically calculated by the built-in timer. The method of calculating the equivalent light hour is as follows:

1. Light Usage Time = $(x+y1+y2+z)$ hours, if
Time used in **Normal** mode = x hours
Time used in **ECO 1** mode = y1 hours
Time used in **ECO 2** mode = y2 hours
Time used in **SmartEco** mode = z hours
2. Equivalent Light Hour = α hours

$$\alpha = \frac{A'}{X} \times x + \frac{A'}{Y1} \times y1 + \frac{A'}{Y2} \times y2 + \frac{A'}{Z} \times z \quad , \text{ if}$$

X= light source life spec of **Normal** mode

Y1= light source spec of **ECO 1** mode (**Bright** mode)

Y2= light source spec of **ECO 2** mode (Other modes)

Z= light source spec of **SmartEco** mode

A' is the longest light life spec among X, Y1, Y2, Z.



For time used in each light source mode shown in OSD menu:

- Time used is accumulated and rounded down to an integer in **hours**.
- When time used is less than 1 hour, it shows 0 hours.



When you calculate **Equivalent Light Hours** manually, it will probably have deviation from the value shown in OSD menu since projector system calculates time used for each light source mode in “Minutes” then rounds down to an integer in hours shown in OSD.

To obtain the light source information:

Go to **Advanced Menu - System > Light Source Information** and press **OK**. The **Light Source Information** page appears.

You can also get the light hour information on the **Information** menu.

Extending light source life

- Setting the **Light Source Mode**

Go to **Advanced Menu - Picture > Advanced Color Settings > Light Source Mode** and press **◀/▶** to select a suitable light source power from among the provided modes.

Setting the projector in **ECO**, or **SmartEco** mode extends light life.

Light Source Mode	Descriptions
Normal	Provides full light brightness
ECO	Lowers brightness to extend the light life and decreases the fan noise
SmartEco	Adjusts the light power automatically depending on the content brightness level while optimizing display quality.

• Setting **Auto Power Off**











































This function allows the projector to turn off automatically if no input signal is detected after a set period of time to prevent unnecessary waste of light source life.

To set **Auto Power Off**, go to **Advanced Menu - System > Operation Settings > Power On/Off Settings > Auto Power Off**, and press ◀/▶ to set a period of time.

Changing the light source

The LED light can last around 20,000 ~ 30,000 hours. In most cases, it would not be necessary to change the light source during the projector’s lifetime. When it is needed, LED light replacement is not user-serviceable. Please contact the service center for changing LED light.

Indicators

Indicator			Status & Description
POWER ○	TEMP ○	LIGHT ○	
Power events			
			Stand-by mode
			Powering up
			Normal operation
			Normal power-down cooling
			Download
			Light source life exhausted
			Burn-in ON
			Burn-in OFF
Light source events			
			Light source error in normal operation
Thermal events			
			Fan 1 error (the actual fan speed is outside the desired speed)
			Fan 2 error (the actual fan speed is outside the desired speed)
			Fan 3 error (the actual fan speed is outside the desired speed)
			Temperature 1 error (over limited temperature)
			Thermal IC #1 I2C Connection error



○: Off

: Orange On

: Green On

: Red On

: Orange Flashing

: Green Flashing

: Red Flashing

Troubleshooting

? The projector does not turn on.

Cause	Remedy
There is no power from the power cord.	Plug the power cord into the AC power jack on the projector, and plug the power cord into the power outlet. If the power outlet has a switch, make sure that it is switched on.
Attempting to turn the projector on again during the cooling process.	Wait until the cooling down process has completed.

? No picture

Cause	Remedy
The video source is not turned on or connected correctly.	Turn the video source on and check that the signal cable is connected correctly.
The projector is not correctly connected to the input signal device.	Check the connection.
The input signal has not been correctly selected.	Select the correct input signal with the SOURCE key.

? Blurred image

Cause	Remedy
The projection lens is not correctly focused.	Adjust the focus of the lens using the focus ring.
The projector and the screen are not aligned properly.	Adjust the projection angle and direction as well as the height of the projector if necessary.

? Abnormal image

Cause	Remedy
The image is abnormal.	<ul style="list-style-type: none"> • Ensure the video source cable is connected properly, and that the video source is turned on. • Ensure that the air intake or exhaust is not blocked.

? Remote control does not work.

Cause	Remedy
The batteries are out of power.	Replace both of the batteries with new ones.
There is an obstacle between the remote control and the projector.	Remove the obstacle.
You are too far away from the projector.	Stand within 8 meters (26 feet) of the projector.

? The password is incorrect.

Cause	Remedy
You do not remember the password.	See Entering the password recall procedure on page 21 .

Specifications

Projector specifications



All specifications are subject to change without notice.

Optical

Resolution

1920 x 1080

Display system

1-CHIP DMD

Lens

F = 2.6 to 2.78, f = 10.2 to 12.24 mm

Clear focus range

0.91 – 1.83 m @ Wide,

1.10 – 2.19 m @ Tele

Light source

LED

Electrical

Power supply

AC100–240V, 2.9 A, 50–60 Hz (Automatic)

Power consumption

240 W (Max); < 0.5 W (Standby)

Mechanical

Weight

3.6 Kg ± 100 g (7.94 ± 0.22 lbs)

Output terminals

Speaker

5 watt TreVolo x 2

Audio signal output

Audio jack x 1

SPDIF x 1

Control

RS-232 serial control

9 pin x 1

IR receiver x 2

Input terminals

Digital

HDMI-1/HDMI-2 (2.0b, HDCP 2.2) x 2

USB

2.0 Type-A x 1 (Power supply, 5V/2.5A)

Audio signal input

Audio in x 1

(Only works when the projector input source is set to HDMI, and is connected to a DVI device via a DVI cable with a DVI-to-HDMI adapter.)

Environmental Requirements

Operating temperature

0°C–40°C at sea level

Storage temperature

-20°C–60°C at sea level

Operating/Storage relative humidity

10%–90% (without condensation)

Operating altitude

0–1499 m at 0°C–35°C

1500–3000 m at 0°C–30°C (with

High Altitude Mode on)

Storage altitude

30°C @ 0–12,200 m above sea level

Repairing

Please visit below website and choose your country to find your service contact window.

<http://www.benq.com/welcome>

Transporting

Original packing or equivalent is recommended.

Dimensions

366 mm (W) x 118 mm (H) x 244 mm (D)

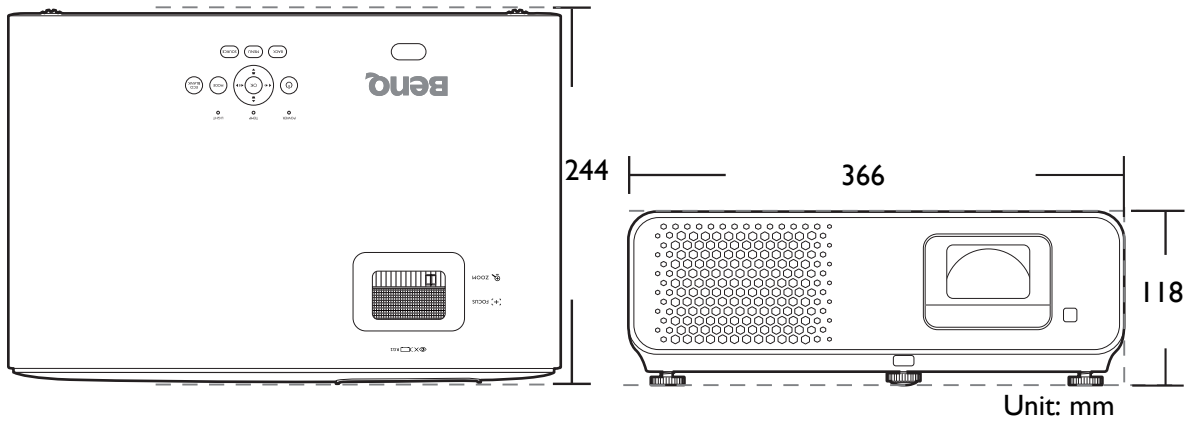

Timing chart

Supported timing for HDMI (HDCP) input

- PC timings

Resolution	Mode	Vertical Frequency (Hz)	Horizontal Frequency (kHz)	Pixel Frequency (MHz)	Supported 3D format		
					Frame Sequential	Top Bottom	Side-by-Side
640 x 480	VGA_60	59.940	31.469	25.175		V	V
	VGA_72	72.809	37.861	31.500			
	VGA_75	75.000	37.500	31.500			
	VGA_85	85.008	43.269	36.000			
720 x 400	720 x 400_70	70.087	31.469	28.3221			
800 x 600	SVGA_60	60.317	37.879	40.000		V	V
	SVGA_72	72.188	48.077	50.000			
	SVGA_75	75.000	46.875	49.500			
	SVGA_85	85.061	53.674	56.250			
	SVGA_120 (Reduce Blanking)	119.854	77.425	83.000	V		
1024 x 768	XGA_60	60.004	48.363	65.000		V	V
	XGA_70	70.069	56.476	75.000			
	XGA_75	75.029	60.023	78.750			
	XGA_85	84.997	68.667	94.500			
	XGA_120 (Reduce Blanking)	119.989	97.551	115.500	V		
1152 x 864	1152 x 864_75	75.00	67.500	108.000			
1024 x 576@60Hz	BenQ Notebook Timing	60.00	35.820	46.996			
1024 x 600@65Hz	BenQ Notebook Timing	64.995	41.467	51.419			
1280 x 720	1280 x 720_60	60	45.000	74.250		V	V
1280 x 768	1280 x 768_60	59.870	47.776	79.5		V	V
1280 x 800	WXGA_60	59.810	49.702	83.500		V	V
	WXGA_75	74.934	62.795	106.500			
	WXGA_85	84.880	71.554	122.500			
	WXGA_120 (Reduce Blanking)	119.909	101.563	146.25	V		
1280 x 1024	SXGA_60	60.020	63.981	108.000		V	V
	SXGA_75	75.025	79.976	135.000			
	SXGA_85	85.024	91.146	157.500			
1280 x 960	1280 x 960_60	60.000	60.000	108		V	V
	1280 x 960_85	85.002	85.938	148.500			
1360 x 768	1360 x 768_60	60.015	47.712	85.500		V	V
1440 x 900	WXGA+_60	59.887	55.935	106.500		V	V
1400 x 1050	SXGA+_60	59.978	65.317	121.750		V	V
1600 x 1200	UXGA	60.000	75.000	162.000		V	V
1680 x 1050	1680 x 1050_60	59.954	65.290	146.250		V	V
640 x 480@67Hz	MAC13	66.667	35.000	30.240			
832 x 624@75Hz	MAC16	74.546	49.722	57.280			
1024 x 768@75Hz	MAC19	75.020	60.241	80.000			
1152 x 870@75Hz	MAC21	75.06	68.68	100.00			
1920 x 1080@60Hz	1920 x 1080_60	60	67.5	148.5	V	V	V
1920 x 1200@60Hz	1920 x 1200_60 (Reduce Blanking)	59.95	74.038	154	V	V	V
1920 x 1200@120Hz	1920 x 1200_120 (Reduce Blanking)	119.909	152.404	317.0			
1920 x 1080@60Hz (VESA)	1920 x 1080_60 (For Auditorium model)	59.963	67.158	173			
1920 x 1080 @120Hz	1920 x 1080_120 (Only HDMI 2.0)	120.000	135.000	297			
3840 x 2160	3840 x 2160_30 (For 4K2K model)	30	67.5	297			

3840 x 2160	3840 x 2160_60 (For 4K2K model) (Only HDMI 2.0)	60	135	594			
-------------	---	----	-----	-----	--	--	--



The timings showing above may not be supported due to EDID file and VGA graphics card limitations. It is possible that some timings cannot be chosen.

• Video timings

Timing	Resolution	Vertical Frequency (Hz)	Horizontal Frequency (kHz)	Pixel Frequency (MHz)	Supported 3D format			
					Frame Sequential	Frame Packing	Top Bottom	Side-by-Side
480i	720(1440) x 480	59.94	15.73	27				
480p	720 x 480	59.94	31.47	27				
576i	720(1440) x 576	50	15.63	27				
576p	720 x 576	50	31.25	27				
720/50p	1280 x 720	50	37.5	74.25		V	V	V
720/60p	1280 x 720	60	45.00	74.25		V	V	V
1080/24P	1920 x 1080	24	27	74.25		V	V	V
1080/25P	1920 x 1080	25	28.13	74.25				
1080/30P	1920 x 1080	30	33.75	74.25				
1080/50i	1920 x 1080	50	28.13	74.25				V
1080/60i	1920 x 1080	60	33.75	74.25				V
1080/50P	1920 x 1080	50	56.25	148.5			V	V
1080/60P	1920 x 1080	60	67.5	148.5			V	V
1080/120P	1920 x 1080	120	135	297				
2160/24P	3840 x 2160 (Only HDMI 2.0)	24	54	297				
2160/25P	3840 x 2160 (Only HDMI 2.0)	25	56.25	297				
2160/30P	3840 x 2160 (Only HDMI 2.0)	30	67.5	297				
2160/50P	3840 x 2160 (Only HDMI 2.0)	50	112.5	594				
2160/60P	3840 x 2160 (Only HDMI 2.0)	60	135	594				

RS232 command

RS232 pin assignment

No.	Serial
1	NC
2	RX
3	TX
4	NC
5	GND

No.	Serial
6	NC
7	RTSZ
8	CTSZ
9	NC

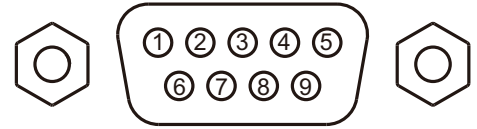

Function	Type	Operation	ASCII
Power	Write	Power On	<CR>*pow=on#<CR>
	Write	Power Off	<CR>*pow=off#<CR>
	Read	Power Status	<CR>*pow=?#<CR>
Source Selection	Write	HDMI(MHL)	<CR>*sour=hdmi#<CR>
	Write	HDMI 2(MHL2)	<CR>*sour=hdmi2#<CR>
	Read	Current source	<CR>*sour=?#<CR>
Audio Control	Write	Mute On	<CR>*mute=on#<CR>
	Write	Mute Off	<CR>*mute=off#<CR>
	Read	Mute Status	<CR>*mute=?#<CR>
	Write	Volume +	<CR>*vol=+#<CR>
	Write	Volume -	<CR>*vol=-#<CR>
	Write	Volume level for customer	<CR>*vol=value#<CR>
Picture Mode	Read	Volume Status	<CR>*vol=?#<CR>
	Write	Bright	<CR>*appmod=bright#<CR>
	Write	Living Room	<CR>*appmod=livingroom#<CR>
	Write	Game	<CR>*appmod=game#<CR>
	Write	Cinema (Rec.709)	<CR>*appmod=cine#<CR>
	Write	User1	<CR>*appmod=user1#<CR>
	Write	3D	<CR>*appmod=threed#<CR>
	Write	Sport	<CR>*appmod=sport#<CR>
	Write	HDR10	<CR>*appmod=hdr#<CR>
Write	HLG	<CR>*appmod=hlg#<CR>	
Picture Setting	Read	Picture Mode	<CR>*appmod=?#<CR>
	Write	Set Contrast value	<CR>*con=value#<CR>
	Read	Contrast value	<CR>*con=?#<CR>
	Write	Brightness +	<CR>*bri=+#<CR>
	Write	Brightness -	<CR>*bri=-#<CR>
	Write	Set Brightness value	<CR>*bri=value#<CR>
	Read	Brightness value	<CR>*bri=?#<CR>
	Write	Sharpness +	<CR>*sharp=+#<CR>
	Write	Sharpness -	<CR>*sharp=-#<CR>
	Write	Set Sharpness value	<CR>*sharp=value#<CR>
	Read	Sharpness value	<CR>*sharp=?#<CR>
	Write	Color Temperature-Warm	<CR>*ct=warm#<CR>
	Write	Color Temperature-Normal	<CR>*ct=normal#<CR>
	Write	Color Temperature-Cool	<CR>*ct=cool#<CR>
	Write	Color Temperature-lamp native	<CR>*ct=ative#<CR>
Read	Color Temperature Status	<CR>*ct=?#<CR>	
Write	Aspect 4:3	<CR>*asp=4:3#<CR>	

Picture Setting (Continued)	Write	Aspect 16:9	<CR>*asp=16:9#<CR>
	Write	Aspect Auto	<CR>*asp=AUTO#<CR>
	Read	Aspect Status	<CR>*asp=?#<CR>
	Write	Vertical Keystone +	<CR>*vkeystone=+#<CR>
	Write	Vertical Keystone -	<CR>*vkeystone=-#<CR>
	Read	Vertical Keystone value	<CR>*vkeystone=?#<CR>
	Write	Horizontal Keystone +	<CR>*hkeystone=+#<CR>
	Write	Horizontal Keystone -	<CR>*hkeystone=-#<CR>
	Read	Horizontal Keystone value	<CR>*hkeystone=?#<CR>
	Write	Reset current picture settings	<CR>*rstcurpicsetting#<CR>
	Write	Reset all picture settings	<CR>*rstallpicsetting#<CR>
Operation Settings	Write	Projector Position-Front Table	<CR>*pp=FT#<CR>
	Write	Projector Position-Rear Table	<CR>*pp=RE#<CR>
	Write	Projector Position-Rear Ceiling	<CR>*pp=RC#<CR>
	Write	Projector Position-Front Ceiling	<CR>*pp=FC#<CR>
	Read	Projector Position Status	<CR>*pp=?#<CR>
	Write	Quick auto search on	<CR>*QAS=on#<CR>
	Write	Quick auto search off	<CR>*QAS=off#<CR>
	Read	Quick auto search status	<CR>*QAS=?#<CR>
	Write	Menu Position - Center	<CR>*menuposition=center#<CR>
	Write	Menu Position - Top-Left	<CR>*menuposition=tl#<CR>
	Write	Menu Position - Top-Right	<CR>*menuposition=tr#<CR>
	Write	Menu Position - Bottom-Right	<CR>*menuposition=br#<CR>
	Write	Menu Position - Bottom-Left	<CR>*menuposition=bl#<CR>
	Read	Menu Position Status	<CR>*menuposition=?#<CR>
	Write	Direct Power On-on	<CR>*directpower=on#<CR>
Write	Direct Power On-off	<CR>*directpower=off#<CR>	
Read	Direct Power On-Status	<CR>*directpower=?#<CR>	
Baud Rate	Write	9600	<CR>*baud=9600#<CR>
	Write	14400	<CR>*baud=14400#<CR>
	Write	19200	<CR>*baud=19200#<CR>
	Write	38400	<CR>*baud=38400#<CR>
	Write	57600	<CR>*baud=57600#<CR>
	Write	115200	<CR>*baud=115200#<CR>
	Read	Current Baud Rate	<CR>*baud=?#<CR>
Lamp Control	Read	Lamp	<CR>*ltim=?#<CR>
	Write	Normal mode	<CR>*lampm=lnor#<CR>
	Write	Eco mode	<CR>*lampm=eco#<CR>
	Write	SmartEco mode	<CR>*lampm=seco#<CR>
Read	Lamp Mode Status	<CR>*lampm=?#<CR>	

Miscellaneous	Read	Model Name	<CR>*modelname=?#<CR>
	Read	System F/W Version	<CR>*sysfwversion=?#<CR>
	Read	Scaler F/W Version	<CR>*scalerfwversion=?#<CR>
	Read	MCU F/W Version	<CR>*mcfwversion=?#<CR>
	Write	Blank On	<CR>*blank=on#<CR>
	Write	Blank Off	<CR>*blank=off#<CR>
	Read	Blank Status	<CR>*blank=?#<CR>
	Write	Menu On	<CR>*menu=on#<CR>
	Write	Menu Off	<CR>*menu=off#<CR>
	Read	Menu Status	<CR>*menu=?#<CR>
	Write	Up	<CR>*up#<CR>
	Write	Down	<CR>*down#<CR>
	Write	Right	<CR>*right#<CR>
	Write	Left	<CR>*left#<CR>
	Write	Enter	<CR>*enter#<CR>
	Write	Back	<CR>*back#<CR>
	Write	Source Menu On	<CR>*sourmenu=on#<CR>
	Write	Source Menu Off	<CR>*sourmenu=off#<CR>
	Read	Source Menu Status	<CR>*sourmenu=?#<CR>
	Write	3D Sync Off	<CR>*3d=off#<CR>
	Write	3D Auto	<CR>*3d=auto#<CR>
	Write	3D Sync Top Bottom	<CR>*3d=tb#<CR>
	Write	3D Sync Frame Sequential	<CR>*3d=fs#<CR>
	Write	3D Frame packing	<CR>*3d=fp#<CR>
	Write	3D Side by side	<CR>*3d=sbs#<CR>
	Write	3D inverter disable	<CR>*3d=da#<CR>
	Write	3D inverter	<CR>*3d=iv#<CR>
	Read	3D Sync Status	<CR>*3d=?#<CR>
	Write	High Altitude mode on	<CR>*Highaltitude=on#<CR>
	Write	High Altitude mode off	<CR>*Highaltitude=off#<CR>
Read	High Altitude mode status	<CR>*Highaltitude=?#<CR>	
Color Calibration (only for service)	Write	Set BenQ gamma value	<CR>*gamma=value#<CR>
	Read	Gamma value status	<CR>*gamma=?#<CR>
	Write	Set HDR Brightness value	<CR>*hdrbri=value#<CR>
	Read	Get HDR Brightness value	<CR>*hdibri=?#<CR>
	Write	Set Red Gain value	<CR>*RGain=value#<CR>
	Read	Get Red Gain value	<CR>*RGain=?#<CR>
	Write	Set Green Gain value	<CR>*GGain=value#<CR>
	Read	Get Green Gain value	<CR>*GGain=?#<CR>
	Write	Set Blue Gain value	<CR>*BGain=value#<CR>
	Read	Get Blue Gain value	<CR>*BGain=?#<CR>
	Write	Set Red Offset value	<CR>*ROffset=value#<CR>
	Read	Get Red Offset value	<CR>*ROffset=?#<CR>
	Write	Set Green Offset value	<CR>*GOffset=value#<CR>
	Read	Get Green Offset value	<CR>*GOffset=?#<CR>

Color Calibration (only for service) (Continued)	Write	Set Blue Offset value	<CR>*BOffset=value#<CR>
	Read	Get Blue Offset value	<CR>*BOffset=?#<CR>
	Write	Primary Color	<CR>*primcr=value#<CR>
	Read	Primary Color Status	<CR>*primcr=?#<CR>
	Write	Set Hue value	<CR>*hue=value#<CR>
	Read	Get Hue value	<CR>*hue=?#<CR>
	Write	Set Saturation value	<CR>*saturation =value#<CR>
	Read	Get Saturation value	<CR>*saturation =?#<CR>
	Write	Set Gain value	<CR>*gain=value#<CR>
	Read	Get Gain value	<CR>*gain=?#<CR>
Service (Only for service)	Write	Service mode enable for error report	<CR>*error=enable#<CR>
	Read	Error code report	<CR>*error=report#<CR>
	Read	FAN 1 speed	<CR>*fan1=?#<CR>
	Read	FAN 2 speed	<CR>*fan2=?#<CR>
	Read	FAN 3 speed	<CR>*fan3=?#<CR>
	Read	Temperature 1	<CR>*tmp1=?#<CR>
	Read	LED indicator	<CR>*led=?#<CR>